

2014 NOVEMBER
APPLICATION CHART



*Travel
Collection*

**BORN TO
UNLIMITED
RIDE**



**MOTORCYCLE
ACCESSORIES**



In any case.



In any case.

INDEX

TOP-BOXES AND SIDE CASES	3 > 21
SOFT BAGS	22 > 39
VARIOUS ACCESSORIES	40 > 45
TECHNICAL ACCESSORIES	46 > 48
UNIVERSAL AIRSTARS & SPOILER	49 > 52
P.O.S. MATERIAL	53
SPECIFIC EQUIPMENT FOR MOTORCYCLES AND SCOOTERS	54 > 124
PLATES	125 > 126
SPARE PARTS	127 > 152
MOUNTING EXAMPLES	153 > 157

ORDERS AND DELIVERIES

For a more efficient ordering service, we kindly ask you to transmit your orders via the internet at the following address:

www.kappamoto.com (web-order area).

Please contact our offices to ask for your personal password and any further explanation you might need thereabout.

All orders sent via internet will have absolute priority.



FAX +39. 030. 3581444



TEL. +39. 030. 2686970



**INFO-LINE export@kappamoto.com
WEB SITE www.kappamoto.com**

WEB ORDER weborder.kappamoto.com

AREA FTP cloud.kappamoto.com

**APP [Kappa Showcase](#)
Download from App Store**

**SOCIAL www.facebook.com/kappamoto
canale you tube: [TheKappaChannel](#)**

SITO INTERNET www.kappamoto.com

PACKAGING COST CONTRIBUTION

All accessories except hard cases (that have their own packaging) are shipped assembled in carton boxes for transportation.

A packaging cost contribution will be charged on every invoice and calculated as 1.30 Euro per each carton box in the shipment (except cases).

CASES



MONOKEY® FITTING SYSTEM

Monokey® is the fitting system for panniers and top cases most famous both for bikers and scooter riders all over the world. Patented by GIVI, adopted by KAPPA, the Monokey® has introduced the possibility to operate with only one key both for the opening of the top case and the detachment of the case from the fitting plate. It is universally famous for its mechanic characteristic, that permits the user to travel in complete security and also for an adventure use, thanks to the high level of rigidity of the system, combined with compact and light components. The secret is the uniform distribution of the load on the plate surface, guaranteed by the three fitting points, which are placed in such a way to obtain the widest possible contact surface. The damping of oscillating and vibration and the contact between the bottom shell and the plate are assured by four spacers made of elastic material, which is particularly resistant to extreme weather and temperature variation. Thanks to these solutions a high level of reliability of the fitting is guaranteed even under the heaviest stresses and strains over the years.



MONOLOCK® FITTING SYSTEM

Projected to offer a wider range of applications and uses of the top-cases, the Monolock® system has been conceived for lighter vehicles, such as scooters and maxi-scooters, used mainly for short/mid range commuter transport requirements. The Monolock®, introduced by GIVI, follows the same philosophy that defines the Monokey® fitting system, like the opening of the case top shell and the detachment of the case from the plate with one key only- thought to support less weight, without losing nothing in reliability and performances, but obtaining characteristics of lightness and more reduced overall.



MONOKEY® SIDE FITTING SYSTEM

This system represents an interesting alternative for the biker interested in mounting on his bike a pair of panniers. The innovative elements that characterize the Monokey® Side can be recognized by the shape of the inclined holder and by the two fixing points, composed by "sleds". The latter receive the disengagement movement from the case release button and determine a significant and further increase on overall stability. The Monokey® Side allows to obtain a major adhesion of the case to the side of the motorcycle, improving the aerodynamic aspect. As the two previous systems, also the Monokey® Side makes use of the comfortable and rapid opening system and release with the same key.



FIXED FITTING SYSTEM

This fitting system, developed by KAPPA, is the most universal from the ones previously described. Designed for scooter boxes from the KCY25 range and for the model KCY14N for bicycles, it uses the bottom as a base for a secure and stable fitting on all vehicles equipped with luggage carrier. The kit is complete of metallic supports and screws. With very simple modifications, practicable by the user, the KCY25 and KCY14N top-cases can become compatible with the original luggage carriers present on the market.

KVE42A K-VENTURE Monokey®

KVE42A

Painted lid MONOKEY top-case 42 lt. in aluminium 1,5 mm thickness, with polymer edges and internal reinforcements in profiled aluminium.

NEW

open
MONOKEY SYSTEM®
close



TECH INFO



KVE37APACK2 K-VENTURE

KVE37APACK2

Pair of side cases in aluminum 1,5 mm thickness, with polymer edges and internal reinforcements in profiled aluminium. They can be mounted on tubular side-case holders KL and KLR where it is specified "compatible with K-Venture". The fitting is enabled through quarter turn screws.

Volume: 37 lt.
Max load: 10 Kg.
Dimensions: (L x H x B) 49,5 x 38,7 x 24,6 cm

NEW

open
MONOKEY SYSTEM®
close



TECH INFO



MOTORCYCLE ACCESSORIES



MONOKEY® SYSTEM

TOP-BOXES AND SIDE CASES

KGR52 GARDA Monokey®

KGR52* Top-case, capacity 52 ltr., equipped with silver cover on top-shell.
***CANNOT BE FITTED ONTO PLATES WITH AN INSTALLED ELECTRICAL CONTACT FOR A STOP LIGHT KIT**

OPTIONAL

- K635** Backrest
- K9915** Top rack
- E125*** Kit of 4 rings for the fitting of the elastic net K9910.
***IN ORDER TO FIT THEM YOU MUST DRILL FOUR HOLES OF Ø 10MM**
- K9910N** Elastic carrying net
- TK756** Internal bag for KGR33, KGR46, KGR52, K53, K48, K961, K49, K49NT, K40, K47, K47NT, K47NN, K47B.
- KSL101** Set of 1 key locks with corresponding bush including under lock platels. compatible with the following models of cases: KVE42A - KVE37APACK2 - KGR52 - KGR33 - KGR46 - K49 - K49NT - K47 - K47NN - K47NT - K466 - K46 - K46NT - K37 - K37NN - K37NT - K35 - K35NT - K33 - K26..



TECH INFO



KGR46 GARDA Monokey®

KGR46* Top-case, capacity 46 ltr., equipped with silver cover on top-shell.
***CANNOT BE FITTED ONTO PLATES WITH AN INSTALLED ELECTRICAL CONTACT FOR A STOP LIGHT KIT**

KGR46PACK2* Set of two KGR46 Garda cases with the same key, equipped with a third key cylinder with the same key number of the two cases
***CANNOT BE FITTED ONTO PLATES WITH AN INSTALLED ELECTRICAL CONTACT FOR A STOP LIGHT KIT**

OPTIONAL

- K632** Backrest
- K9914** Top rack
- E125*** Kit of 4 rings for the fitting of the elastic net K9910.
***IN ORDER TO FIT THEM YOU MUST DRILL FOUR HOLES OF Ø 10MM**
- K9910N** Elastic carrying net
- TK756** Internal bag for KGR33, KGR46, KGR52, K53, K48, K961, K49, K49NT, K40, K47, K47NT, K47NN, K47B.
- KSL101** Set of 1 key locks with corresponding bush including under lock platels. compatible with the following models of cases: KVE42A - KVE37APACK2 - KGR52 - KGR33 - KGR46 - K49 - K49NT - K47 - K47NN - K47NT - K466 - K46 - K46NT - K37 - K37NN - K37NT - K35 - K35NT - K33 - K26..



TECH INFO



KGR33 GARDA Monokey®

KGR33* Top-case, capacity 33 ltr., equipped with silver cover on top-shell
***CANNOT BE FITTED ONTO PLATES WITH AN INSTALLED ELECTRICAL CONTACT FOR A STOP LIGHT KIT**

KGR33PACK2* Set of two KGR33 Garda cases with the same key, equipped with a third key cylinder
***CANNOT BE FITTED ONTO PLATES WITH AN INSTALLED ELECTRICAL CONTACT FOR A STOP LIGHT KIT**

OPTIONAL

- K632** Backrest
- K9914** Top rack
- E125*** Kit of 4 rings for the fitting of the elastic net K9910.
***IN ORDER TO FIT THEM YOU MUST DRILL FOUR HOLES OF Ø 10MM**
- K9910N** Elastic carrying net
- TK756** Internal bag for KGR33, KGR46, KGR52, K53, K48, K961, K49, K49NT, K40, K47, K47NT, K47NN, K47B.
- KSL101** Set of 1 key locks with corresponding bush including under lock platels. compatible with the following models of cases: KVE42A - KVE37APACK2 - KGR52 - KGR33 - KGR46 - K49 - K49NT - K47 - K47NN - K47NT - K466 - K46 - K46NT - K37 - K37NN - K37NT - K35 - K35NT - K33 - K26..

open
MONOKEY SYSTEM®



TECH INFO

K53N Monokey®

K53N* Top-case, capacity 53 ltr., with transparent reflectors. Black embossed colour
***(WITHOUT PLATE: SEE ITEM.K636)**

OPTIONAL

- TK756** Internal bag for KGR33, KGR46, KGR52, K53, K48, K961, K49, K49NT, K40, K47, K47NT, K47NN, K47B.
- K612** Backrest
- V107**** Specific led stop-light
****CHECK THE TRAFFIC LAWS OF YOUR OWN CONUTRY BEFORE USING THIS STOP-LIGHT KIT ON PUBBLIC ROADS.**

open
MONOKEY SYSTEM®



TECH INFO

MOTORCYCLE ACCESSORIES

K49 Monokey®

- K49N*** Top-case, capacity 47 ltr., with black embossed cover
*(WITHOUT PLATE: SEE ITEM K636)
ITEM SOLD IN PAIRS, THE PRICE IS TO BE INTENDED AS A UNIT PRICE
- K49NS*** Top-case, capacity 47 ltr., without cover
*(WITHOUT PLATE: SEE ITEM K609)
ITEM SOLD IN PAIRS, THE PRICE IS TO BE INTENDED AS A UNIT PRICE
- K49NT*** Top-case, capacity 47 ltr., with black embossed cover. Equipped with transparent reflectors
*(WITHOUT PLATE: SEE ITEM K636)
ITEM SOLD IN PAIRS, THE PRICE IS TO BE INTENDED AS A UNIT PRICE

OPTIONAL	
KC49N	Black embossed cover for K49NS
KC49_ _ _	Painted cover for K49NS (standard colours) and specific colours (B915,G743, G764, N901)
K631	Backrest
V105**	Specific led stop-light **CHECK THE TRAFFIC LAWS OF YOUR OWN COUNTRY BEFORE USING THIS STOP-LIGHT KIT ON PUBLIC ROADS.
TK756	Internal bag for KGR33, KGR46, KGR52, K53, K48, K961, K49, K49NT, K40, K47, K47NT, K47NN, K47B.
KSL101	Set of 1 key locks with corresponding bush including under lock platels. compatible with the following models of cases: KVE42A - KVE37APACK2 - KGR52 - KGR33 - KGR46 - K49 - K49NT - K47 - K47NN - K47NT - K466 - K46 - K46NT - K37 - K37NN - K37NT - K35 - K35NT - K33 - K26..



K49N

BASIC COVER COLOURS



TECH INFO



K49NG730



K49NT

K48N Monokey®

- K48N*** Top-case, capacity 48 ltr., black embossed colour
*(WITHOUT PLATE: SEE ITEM K636)
ITEM SOLD IN PAIRS, THE PRICE IS TO BE INTENDED AS A UNIT PRICE

OPTIONAL	
K9912	Top rack
K611	Backrest
V90**	Stop-light kit **** CHECK THE TRAFFIC LAWS OF YOUR OWN COUNTRY BEFORE USING THIS STOP-LIGHT KIT ON PUBLIC ROADS.
TK756	Internal bag for KGR33, KGR46, KGR52, K53, K48, K961, K49, K49NT, K40, K47, K47NT, K47NN, K47B.



TECH INFO



K961N Monokey®

K961N* ↘ Top-case, capacity 44 ltr., pannier with reflectors. Black colour
 *(WITHOUT PLATE: SEE ITEM K636)
 ITEM SOLD IN PAIRS, THE PRICE IS TO BE INTENDED AS A UNIT PRICE

OPTIONAL	
K604	Backrest
K9911	Metal rack
TK756	Internal bag for KGR33, KGR46, KGR52, K53, K48, K961, K49, K49NT, K40, K47, K47NT, K47NN, K47B.



TECH INFO



K22N Monokey®

K22N* Pair of panniers, capacity 22 ltr., black embossed colour
 ** THESE ITEMS ARE SOLD IN PAIRS AND ARE NOT AVAILABLE INDIVIDUALLY.



TECH INFO



K21N Monokey®

K21N* ↘ Pair of panniers, capacity 21 ltr., black embossed colour
 ** THESE ITEMS ARE SOLD IN PAIRS AND ARE NOT AVAILABLE INDIVIDUALLY.



TECH INFO



↘ = Item available until it runs out of stock

MOTORCYCLE ACCESSORIES

K40N

Monokey®

K40N*

Pair of panniers, capacity 40 ltr., black colour

***THESE ITEMS ARE SOLD IN PAIRS AND ARE NOT AVAILABLE INDIVIDUALLY.**

OPTIONAL

K622

Painted lid cover, colour N902

TK756

Internal bag for KGR33, KGR46, KGR52, K53, K48, K961, K49, K49NT, K40, K47, K47NT, K47NN, K47B.



TOP-BOXES AND SIDE CASES



TECH INFO



K33N

Monokey® Side

K33N*

Pair of panniers, capacity 33 ltr., equipped with the new MONOKEY SIDE fitting system. Black colour

***ATTENTION: THIS CASE CAN BE MOUNTED ONLY WITH THE TUBULAR SIDE-CASE HOLDER KLX/KLXR.**

OPTIONAL

TK755

Pair of internal polyester bags for K33N cases

KSL102

Unification key kit Security Lock for 2 cases, including under lock plates. Compatible with the following models of cases: KVE42A - KVE37APACK2 - KGR52 - KGR33 - KGR46 - K49 - K49NT - K47 - K47NN - K47NT - K466 - K46 - K46NT - K37 - K37NN - K37NT - K35 - K35NT - K33 - K26.



TECH INFO





MONOLOCK® SYSTEM

K47N MANTA Monolock® System

K47N* Top-case, capacity 47 ltr., with red reflectors. Black embossed colour

***ITEM SOLD IN PAIRS, THE PRICE IS TO BE INTENDED AS A UNIT PRICE**

K47A900 Top-case, tech version, capacity 47 ltr., black colour, equipped with smoked reflectors and silver painted cover, plate and universal kit included
ITEM SOLD IN PAIRS, THE PRICE IS TO BE INTENDED AS A UNIT PRICE

OPTIONAL

K633 Polyurethane backrest, black colour

K132 Specific remote control

V108K** Specific led stop-light
****** CHECK THE TRAFFIC LAWS OF YOUR OWN COUNTRY BEFORE USING THIS STOP-LIGHT KIT ON PUBLIC ROADS.**

KSL101 Set of 1 key locks with corresponding bush including under lock platels. compatible with the following models of cases: KVE42A - KVE37APACK2 - KGR52 - KGR33 - KGR46 - K49 - K49NT - K47 - K47NN - K47NT - K466 - K46 - K46NT - K37 - K37NN - K37NT - K35 - K35NT - K33 - K26.

KC47 ___ Cover painted (standard and specific colours)



K47N

BASIC COVER COLOURS

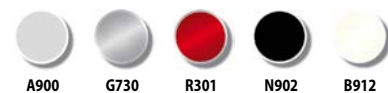

TECH INFO			
34,8 cm 43,6 cm 57,2 cm	Lt. 47	MODULAR	Kg 3 MAX LOAD
TOP CASE	Kg 3,5 CASE WEIGHT	PLATE	LIGHT SYSTEM



K47A900



K47NT MANTA TECH Monolock® System

K47NT* Top-case, tech version, capacity 47 ltr., black colour, equipped with smoked reflectors. Plate and universal kit included.

***ITEM SOLD IN PAIRS, THE PRICE IS TO BE INTENDED AS A UNIT PRICE**

K47A900T Top-case, tech version, capacity 47 ltr., black colour, equipped with smoked reflectors and silver painted cover, plate and universal kit included
ITEM SOLD IN PAIRS, THE PRICE IS TO BE INTENDED AS A UNIT PRICE

OPTIONAL

KC47 ___ Cover painted (standard and specific colours)



K47NT

BASIC COVER COLOURS

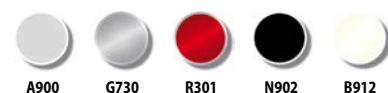

TECH INFO			
34,8 cm 43,6 cm 57,2 cm	Lt. 47	MODULAR	Kg 3 MAX LOAD
TOP CASE	Kg 3,5 CASE WEIGHT	PLATE	LIGHT SYSTEM



K47NT



K47A900T

MOTORCYCLE ACCESSORIES

K47NN MANTA Monolock® System

K47NN* Top-case, capacity 47 ltr., with red reflectors and black cover. Black embossed colour
***ITEM SOLD IN PAIRS, THE PRICE IS TO BE INTENDED AS A UNIT PRICE**

OPTIONAL

- K633** Polyurethane backrest, black colour
- K132** Specific remote control
- V108K**** Specific led stop-light
****** CHECK THE TRAFFIC LAWS OF YOUR OWN COUNTRY BEFORE USING THIS STOP-LIGHT KIT ON PUBLIC ROADS.**
- KSL101** Set of 1 key locks with corresponding bush including under lock platels.
 compatible with the following models of cases: KVE42A - KVE37APACK2 - KGR52 - KGR33 - KGR46 - K49 - K49NT - K47 - K47NN - K47NT - K466 - K46 - K46NT - K37 - K37NN - K37NT - K35 - K35NT - K33 - K26.
- KC47 _ _ _** Cover painted (standard and specific colours)



TECH INFO

34,8 cm 43,6 cm 57,2 cm	Lt. 47	MODULAR	Kg 3
TOP CASE	Kg 3,5	PLATE	LIGHT SYSTEM

K46 Monolock® System

K46N* Top-case, capacity 46 ltr., black colour, universal plate included.
***ITEM SOLD IN PAIRS, THE PRICE IS TO BE INTENDED AS A UNIT PRICE**

K46NT* Top-case, capacity 46 ltr., black colour, equipped with transparent reflectors, universal plate included.
***ITEM SOLD IN PAIRS, THE PRICE IS TO BE INTENDED AS A UNIT PRICE**

OPTIONAL

- K627** Polyurethane backrest, black colour
- V101**** Stop-light kit
****** CHECK THE TRAFFIC LAWS OF YOUR OWN COUNTRY BEFORE USING THIS STOP-LIGHT KIT ON PUBLIC ROADS.**
- KSL101** Set of 1 key locks with corresponding bush including under lock platels.
 compatible with the following models of cases: KVE42A - KVE37APACK2 - KGR52 - KGR33 - KGR46 - K49 - K49NT - K47 - K47NN - K47NT - K466 - K46 - K46NT - K37 - K37NN - K37NT - K35 - K35NT - K33 - K26.



TECH INFO

32 cm 41 cm 55 cm	Lt. 46	TOP CASE	JET
LIGHT SYSTEM	Kg 3	PLATE	Kg 4,0



K46N



K466 URBAN Monolock® System

- K466N*** Top-case, capacity 46 ltr., universal plate included. Black colour
***ITEM SOLD IN PAIRS, THE PRICE IS TO BE INTENDED AS A UNIT PRICE**
- K466NT*** Top-case, capacity 46 ltr., black colour, equipped with transparent reflectors, universal plate included.
***ITEM SOLD IN PAIRS, THE PRICE IS TO BE INTENDED AS A UNIT PRICE**

OPTIONAL

- KSL101** Set of 1 key locks with corresponding bush including under lock platels. compatible with the following models of cases: KVE42A - KVE37APACK2 - KGR52 - KGR33 - KGR46 - K49 - K49NT - K47 - K47NN - K47NT - K466 - K46 - K46NT - K37 - K37NN - K37NT - K35 - K35NT - K33 - K26.
- KC466** Cover painted (standard and specific colours)

NEW

open
MONOLOCK SYSTEM®
detach



K466N + KC466G126

BASIC COVER COLOURS



TECH INFO			
32,6 cm 14,4 cm 55,9 cm	46 Lt.	TOP CASE	JET
LIGHT SYSTEM	3 Kg MAX LOAD	PLATE	4,0 Kg CASE WEIGHT



K466N



K466NT

K37 Monolock® System

- K37N*** Top-case, capacity 37 ltr., with red reflectors. Black embossed colour
***ITEM SOLD IN PAIRS, THE PRICE IS TO BE INTENDED AS A UNIT PRICE**
- K37NT*** Top-case, tech version, capacity 37 ltr., black colour, equipped with smoked reflectors. Plate and universal kit included.
***ITEM SOLD IN PAIRS, THE PRICE IS TO BE INTENDED AS A UNIT PRICE**
- K37NN*** Top-case, capacity 37 ltr., with red reflectors, black embossed with shiny moulded cover
***ITEM SOLD IN PAIRS, THE PRICE IS TO BE INTENDED AS A UNIT PRICE**

OPTIONAL

- K634** Polyurethane backrest, black colour
- K132** Specific remote control
- V108K**** Specific led stop-light
****** CHECK THE TRAFFIC LAWS OF YOUR OWN COUNTRY BEFORE USING THIS STOP-LIGHT KIT ON PUBBLIC ROADS.**
- KSL101** Set of 1 key locks with corresponding bush including under lock platels. compatible with the following models of cases: KVE42A - KVE37APACK2 - KGR52 - KGR33 - KGR46 - K49 - K49NT - K47 - K47NN - K47NT - K466 - K46 - K46NT - K37 - K37NN - K37NT - K35 - K35NT - K33 - K26.
- KC47** Cover painted (standard and specific colours)

open
MONOLOCK SYSTEM®
detach



K37N

BASIC COVER COLOURS



TECH INFO			
31,5 cm 13,5 cm 49,8 cm	37 Lt.	FULL FACE+JET	MODULAR+JET
TOP CASE	3 Kg MAX LOAD	PLATE	LIGHT SYSTEM



K37NT



K37NN

MOTORCYCLE ACCESSORIES

K35 Monolock® System

K35N* Top-case, capacity 35 ltr., equipped with nylon mounting plate, black colour
***ITEM SOLD IN PAIRS, THE PRICE IS TO BE INTENDED AS A UNIT PRICE**

K35NT* Top-case, capacity 35 ltr., black colour, equipped with transparent reflectors.
***ITEM SOLD IN PAIRS, THE PRICE IS TO BE INTENDED AS A UNIT PRICE**

OPTIONAL	
K627	Polyurethane backrest, black colour
KSL101	Set of 1 key locks with corresponding bush including under lock platels. compatible with the following models of cases: KVE42A - KVE37APACK2 - KGR52 - KGR33 - KGR46 - K49 - K49NT - K47 - K47NN - K47NT - K466 - K46 - K46NT - K37 - K37NN - K37NT - K35 - K35NT - K33 - K26.



K35N



K35NT

TECH INFO

33 cm 41,5 cm 49 cm	Lt. 35	TOP CASE	FULL FACE
Kg 3	PLATE	Kg 3,9	

K30 Monolock® System

K30N* Top-case, capacity 30 ltr., black colour, universal plate included
***THESE ITEMS ARE SOLD IN PACKS OF 4 PIECES EACH, THE PRICE IS TO BE INTENDED AS A UNIT PRICE**

K300N* Top-case, capacity 30 ltr., black colour, universal plate not included.
***THESE ITEMS ARE SOLD IN PACKS OF 4 PIECES EACH, THE PRICE IS TO BE INTENDED AS A UNIT PRICE**

K30NT* Top-case, tech version, capacity 30 ltr., black colour, equipped with smoked reflectors with universal plate K628 included.
***THESE ITEMS ARE SOLD IN PACKS OF 4 PIECES EACH, THE PRICE IS TO BE INTENDED AS A UNIT PRICE**

KC30 Painted cover for K30, standard and specific colour

OPTIONAL	
K630	Backrest



K30N



K30NT

BASIC COVER COLOURS



B912

G730

N902

TECH INFO

31,5 cm 41,5 cm 48,5 cm	Lt. 30	TOP CASE	FULL FACE
Kg 3	PLATE	Kg 2,2	



↘ = Item available until it runs out of stock

K30B Monolock® System

K30B* Top-case, capacity 30 ltr., white moulded top-shell, equipped with smoked reflector
***THIS ITEM IS SOLD IN PACKS OF 4 PIECES EACH, THE PRICE IS TO BE INTENDED AS A UNIT PRICE**

OPTIONAL

K630 Backrest



TECH INFO

K28N Monolock® System

K28N* Top-case, capacity 28 ltr., black colour
***THESE ITEM ARE SOLD IN PACKS OF 4 PIECES EACH, THE PRICE IS TO BE INTENDED AS A UNIT PRICE**

OPTIONAL

K603 Backrest

V93** Stop-light kit
****** CHECK THE TRAFFIC LAWS OF YOUR OWN COUNTRY BEFORE USING THIS STOP-LIGHT KIT ON PUBBLIC ROADS.**



BASIC COVER COLOURS



TECH INFO

MOTORCYCLE ACCESSORIES

K28BAS Monolock® System

K28BAS*

Top-case, capacity 28 ltr., black colour

*THESE ITEM ARE SOLD IN PACKS OF 4 PIECES EACH, THE PRICE IS TO BE INTENDED AS A UNIT PRICE

NEW

open
MONOLOCK SYSTEM®
detach



TECH INFO

PLATE	TOP CASE	FULL FACE	

TOP-BOXES AND SIDE CASES

K26N Monolock® System

K26N*

Top-case, capacity 26 ltr., colour black

*THESE ITEMS ARE SOLD IN PAIRS AND ARE NOT AVAILABLE INDIVIDUALLY

OPTIONAL

K630

Backrest

KSL101

Set of 1 key locks with corresponding bush including under lock platels. compatible with the following models of cases: KVE42A - KVE37APACK2 - KGR52 - KGR33 - KGR46 - K49 - K49NT - K47 - K47NN - K47NT - K466 - K46 - K46NT - K37 - K37NN - K37NT - K35 - K35NT - K33 - K26.

open
MONOLOCK SYSTEM®
detach



TECH INFO

MAX LOAD	PLATE	CASE WEIGHT	



FIXED SYSTEM

NEW



KCY14N TOP-CASE FOR BICYCLE Fixed System

KCY14N Black fixed top-case complete with transparent reflector, capacity 14 lt.



TECH INFO

	14	MAX LOAD	CASE WEIGHT

KCY25N TOP-CASE FOR BICYCLE Fixed System

KCY25N Top-case, capacity 25 ltr., complete with reflector, equipped with universal fitting kit for mounting it on the carrier of the bicycles.

NEW



TECH INFO

	25	MAX LOAD	CASE WEIGHT

MOTORCYCLE ACCESSORIES

“LOCK BARREL KIT” (To allow one key opening of more than one case)

LOCK BARREL KIT (FOR 2 / 3 CASES)

- 1 - K501** Set of 2 key locks with corresponding bush
- 1 - K501N** Set of 2 key locks with corresponding bush and black handle
- 2 - K502** Set of 3 key locks with corresponding bush
- 2 - K502N** Set of 3 key locks with corresponding bush and black handle

LOCK BARRELS (SUITABLE FOR ALL CASES EXCEPT K53 - K30)

- 3 - K500** Lock barrel suitable for all cases except K53 - K30
- 3 - K500N** Replacement key kits with black handle with corresponding bush

LOCK BARRELS SUITABLE FOR K53

- 4 - Z661** Lock barrel for case lock. (thickness key 2,5 mm)

LOCK BARRELS SUITABLE FOR K30

- 5 - Z156** Lock barrel for case lock (thickness key 2 mm)

KEY BLANK

- 6 - Z135** Key blank not numbered for duplication with red handle (thickness key 2 mm)
- 7 - Z661G** Key blank not numbered for duplication with red handle (thickness key 2,5 mm)

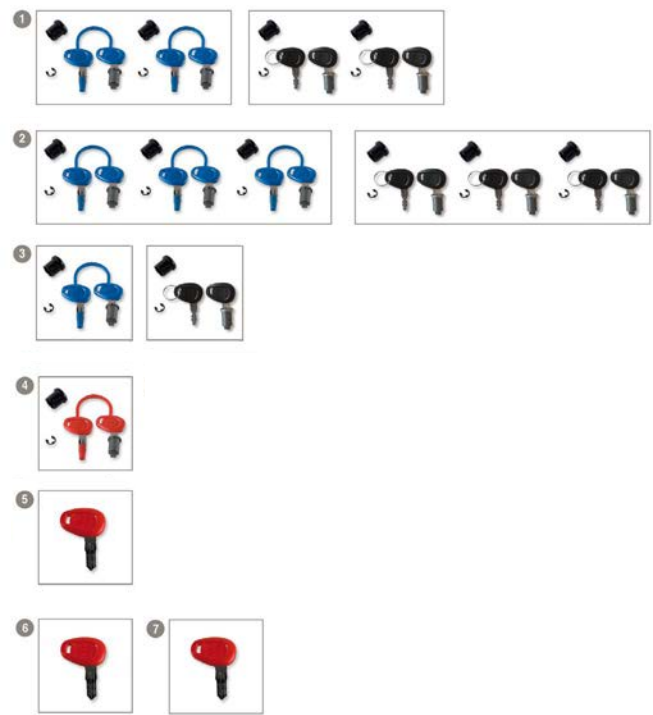

“SECURITY LOCK” KIT



It is the new locking system made by locks of automotive derivation. “Security Lock” heightens the protection level from burglaries, by using components of tempered steel like the cylinders with central armored curving, key with double bit, made in steel with 3mm thickness. This is a solution that KAPPA adopted upon the cases to increase the safety of your luggage (it is the 80% safer than the traditional locks).

The “Security Lock” kit **is compatible** with the following models of cases:
KVE42A - KVE37APACK2 - KGR52 - KGR33 - KGR46 - K49 K49NT - K47 - K47NN - K47NT - K466 - K46 - K46NT - K37 - K37NN - K37NT - K35 - K35NT - K33 - K26

The “Security Lock” kit **cannot be used** on the following models of cases:
K53N - K48N - K961N - K40N - K42N - K30N - K28N - KCY25N - KCY14N

SECURITY LOCK KIT (FOR 1 CASE)

- KSL101 NEW** Set of 1 key locks with corresponding bush including under lock platels. compatible with the following models of cases: KGR33 GARDA, KGR46 GARDA, K47, K47NT, K47B, K49, K49NT, K33, K46, K46NT, K37, K37NT, K35, K35NT, K26.

SECURITY LOCK KIT (FOR 2 CASES)

- KSL102 NEW** Unification key kit Security Lock for 2 cases, including under lock plates. Compatible with the following models of cases: KGR33 GARDA, KGR46 GARDA, K47, K47NT, K47B, K49, K49NT, K33, K46, K46NT, K37, K37NT, K35, K35NT, K26.

SECURITY LOCK KIT (FOR 3 CASES)

- KSL103 NEW** Unification key kit Security Lock for 3 cases, including under lock plates. Compatible with the following models of cases: KGR33 GARDA, KGR46 GARDA, K47, K47NT, K47B, K49, K49NT, K33, K46, K46NT, K37, K37NT, K35, K35NT, K26.

KEY BLANK

- Z2400CNGR** Key blank not numbered for duplication with black handle



BASIC COLOURS AND CORRESPONDING CODE

TOP-CASE	PRICE	PEARL WHITE B912	RED R300	METALLIC RED R301	SILVER G730	GLOSS BLACK N902	METALLIC BLACK N901	MAT SILVER A900
K28	31,91					K28N902 ↘		
K615	10,24			K615R301 ↘			K615N901 ↘	
K622	7,05					K622N902		
K94	36,69				K94G730 ↘			
KC30	10,50	KC30B912			KC30G730	KC30N902 ↘		
KC47	21,05	KC47B912		KC47R301	KC47G730 ↘	KC47N902		KC47A900
KC49	19,25				KC49G730		KC49N901 ↘	
COLOUR OF BASE		BLACK	BLACK	BLACK	BLACK	BLACK	BLACK	BLACK

APRILIA

MODEL-C.C. - YEAR	COLOUR	CODE	TOP-CASE
Scarabeo 50-100 4T (08)	Nero Aprilia	▷ N902	SEE STANDARD COLOURS
Sportcity one 50-125 (08 > 13)	Nero Aprilia	▷ N902	SEE STANDARD COLOURS
Atlantic 125-200-250-300 (03 > 13)	Nero Competition	▶ N931	K35 ↘
Scarabeo 125-200 (00 > 02)	Aprilia Black	▷ N902	SEE STANDARD COLOURS
Scarabeo 125-200 (07 > Giugno '11)	Aprilia Black	▷ N902	SEE STANDARD COLOURS
Scarabeo 125-200 (da Luglio '11 > 14)	Aprilia Black	▷ N902	SEE STANDARD COLOURS
Sportcity 125-200-250 (04 > 08)	Darkness Black	▷ N901	SEE STANDARD COLOURS
	Mirror Silver	▷ G730	SEE STANDARD COLOURS
	Nero Aprilia	▷ N902	SEE STANDARD COLOURS
Sportcity Cube 125-200-300 (08 > 13)	Nero Aprilia	▷ N902	SEE STANDARD COLOURS
Leonardo 125-150-200 (02 > 03)	Aprilia Black	▷ N902	SEE STANDARD COLOURS
Scarabeo 250-300 (07 > 14)	Nero Aprilia	▷ N902	SEE STANDARD COLOURS
	Bianco Glam	▷ B915	KC49 ↘
	Nero Competition	▶ N931	K35 ↘
Scarabeo 250-400-500 ie (08)	Nero Aprilia	▷ N902	SEE STANDARD COLOURS
Atlantic 400-500 Sprint (05 > 12)	Nero Competition	▶ N931	K35 ↘
Scarabeo 400-500 (06 > 12)	Nero Competition	▶ N931	K35 ↘
	Nero Aprilia	▷ N902	SEE STANDARD COLOURS
	Bianco Glam	▷ B915	KC49 ↘
Mana 850 / Mana 850 GT (08 > 14)	Nero Competition	▶ N931	K35 ↘

CAN AM

MODEL-C.C. - YEAR	COLOUR	CODE	TOP-CASE
Spyder 990 (08 > 13)	Deep Black	▷ N902	SEE STANDARD COLOURS

GILERA

MODEL-C.C. - YEAR	COLOUR	CODE	TOP-CASE
Runner 50-125-200 (04 > 05)	Nero Lucido	▷ N902	SEE STANDARD COLOURS
Runner 50-125-200 (06 > 14)	Nero Lucido	▷ N902	SEE STANDARD COLOURS
	Nero Demon	▶ N931	K35 ↘
Nexus 125 (08)	Blue Midnight	▶ B588	K35 ↘
	Nero Cosmo	▶ N931	K35 ↘
Nexus 125-250-300-500 (06 > 14)	Blue Midnight	▶ B588	K35 ↘

GILERA

MODEL-C.C. - YEAR	COLOUR	CODE	TOP-CASE
	Nero Cosmo	▶ N931	K35 ↘
Fuoco 500 (07 > 14)	Nero Demon	▶ N931	K35 ↘
Nexus 500 (03 > 04)	Grey Ice	▷ G730	SEE STANDARD COLOURS
Nexus 500 (05)	Grey Ice	▷ G730	SEE STANDARD COLOURS

HONDA

MODEL-C.C. - YEAR	COLOUR	CODE	TOP-CASE
Zoomer 50 (Ruckus 50) (04 > 14)	Black	▷ N902	SEE STANDARD COLOURS
Lead 110 (08 > 14)	Black	▷ N902	SEE STANDARD COLOURS
CBF 125 (09 > 14)	Black	▷ N902	SEE STANDARD COLOURS
CBR 125 R (04 > 07)	Black	▷ N902	SEE STANDARD COLOURS
PCX 125-150 (10 > 13)	Pearl Himalayas White	▷ B912	SEE STANDARD COLOURS
@ 125-150 (00 > 03)	Force Silver met.	▷ G730	SEE STANDARD COLOURS
@ 125-150 (04 > 08)	Heavy Grey Met.	▶ G743	KC49 ↘
Dylan 125-150 (02 > 07)	Force Silver met.	▷ G730	SEE STANDARD COLOURS
	Red Met.	▷ R301	SEE STANDARD COLOURS
	Candy Xenon Blue	▷ B529	K35 ↘
Pantheon 125-150 (98 > 02)	Force Silver met.	▷ G730	SEE STANDARD COLOURS
Pantheon 125-150 (03 > 08)	Candy Xenon Blue	▷ B529	K35 ↘
	Force Silver Met.	▷ G730	SEE STANDARD COLOURS
PS 125-150i (07 > 08)	Candy Xenon Blue	▷ B529	K35 ↘
	Pearl Cool White	▷ B912	SEE STANDARD COLOURS
PS 125-150i (09)	Pearl Cool White	▷ B912	SEE STANDARD COLOURS
SH 125-150 (01 > 04)	Bright Black	▷ N902	SEE STANDARD COLOURS
	Force Silver Met.	▷ G730	SEE STANDARD COLOURS
SH 125i-150i (05 > 08)	Highlands Green Metallic	▶ G743	KC49 ↘
	Pearl Cool White	▷ B912	SEE STANDARD COLOURS
	Black	▷ N902	SEE STANDARD COLOURS
SH 125i-150i (09 > 12)	Pearl Cool White	▷ B912	SEE STANDARD COLOURS
SH 125i-150i ABS (12 > 14)	Pearl Cool White	▷ B912	SEE STANDARD COLOURS
SH MODE 125 (13 > 14)	Pearl Cool White	▷ B912	SEE STANDARD COLOURS
XL 125V Varadero (01 > 06)	Bright Black	▷ N902	SEE STANDARD COLOURS
XL 125V Varadero (07 > 14)	Moody Blue	▷ B529	K35 ↘
Foresight 250 (97 > 08)	Force Silver Met.	▷ G730	SEE STANDARD COLOURS

MOTORCYCLE ACCESSORIES

HONDA

MODEL-C.C. - YEAR	COLOUR	CODE	TOP-CASE
Forza 250 X (05 > 07)	Cyber Silver Met.	▶ G764	KC49 ↘
Forza 250 X / EX (08 > 12)	Graphite Black	▷ N902	SEE STANDARD COLOURS
Forza 300 ABS (13 > 14)	Graphite Black	▷ N902	SEE STANDARD COLOURS
Jazz 250 (01 > 04)	Force Silver Met.	▷ G730	SEE STANDARD COLOURS
	Candy Glory Red	▷ R301	SEE STANDARD COLOURS
	Pure Black	▷ N902	SEE STANDARD COLOURS
Jazz 250 (05)	Force Silver Met.	▷ G730	SEE STANDARD COLOURS
	Candy Glori Red	▷ R301	SEE STANDARD COLOURS
SH 300i (07 > 10)	Pearl Cool White	▷ B912	SEE STANDARD COLOURS
SH 300i (11 > 14)	Pearl Cool White	▷ B912	SEE STANDARD COLOURS
Silver Wing 400 (05)	Cyber Silver Met.	▷ G764	KC49 ↘
Silver Wing 400 (06 > 09)	Cyber Silver Met.	▷ G764	KC49 ↘
	Heavy Grey Metallic	▶ G743	KC49 ↘
SW-T 400/600 (09 > 14)	Pearl Sunbeam White	▷ B912	SEE STANDARD COLOURS
CB 500 F (13 > 14)	Accurate Silver Met.	▷ G730	SEE STANDARD COLOURS
CBF 500 (04 > 12)	Candy Xenon Blue	▷ B529	K35 ↘
	Bright Black	▷ N902	SEE STANDARD COLOURS
	Force Silver Met.	▷ G730	SEE STANDARD COLOURS
CBR 500 R (13 > 14)	Accurate Silver Met.	▷ G730	SEE STANDARD COLOURS
CB 500 X (13 > 14)	Accurate Silver Met.	▷ G730	SEE STANDARD COLOURS
CBF 600S / CBF 600N (04 > 12)	Candy Xenon Blue	▷ B529	K35 ↘
	Accurate Silver Met.	▷ G730	SEE STANDARD COLOURS
CBR 600 (02)	Accurate Silver Met.	▷ G730	SEE STANDARD COLOURS
CBR 600 (03 > 05)	Bright Black	▷ N902	SEE STANDARD COLOURS
Hornet 600 S (05)	Force Silver Met.	▷ G730	SEE STANDARD COLOURS
Hornet 600 / S (98 > 02)	Candy Xenon Blue	▷ B529	K35 ↘
	Bright Black	▷ N902	SEE STANDARD COLOURS
Hornet 600 (03 > 06)	Candy Xenon Blue	▷ B529	K35 ↘
	Bright Black	▷ N902	SEE STANDARD COLOURS
Hornet 600 / Hornet 600 ABS (07 > 10)	Candy Xenon Blue	▷ B529	K35 ↘
	Pearl Cool White	▷ B912	SEE STANDARD COLOURS
Hornet 600 (11 > 13)	Pearl Cool White	▷ B912	SEE STANDARD COLOURS
Silver Wing 600 / ABS (01 > 09)	Force Silver Met.	▷ G730	SEE STANDARD COLOURS
NT 650 V Deauville (98 > 05)	Shield Silver Met.	▷ G730	SEE STANDARD COLOURS
XL 650V Transalp (00 > 07)	Bright Black	▷ N902	SEE STANDARD COLOURS
	Carnelian Red Metallic	▷ R301	SEE STANDARD COLOURS
	Shield Silver Met.	▷ G730	SEE STANDARD COLOURS
DN-01 700 (08 > 14)	Graphite Black	▷ N902	SEE STANDARD COLOURS
	Pearl Sunbeam White	▷ B912	SEE STANDARD COLOURS
Integra 700 (12 > 13)	Pearl Sunbeam White	▷ B912	SEE STANDARD COLOURS
NC 700S (12 > 13) / NC 750S (14)	Graphite Black	▷ N902	SEE STANDARD COLOURS
	Pearl Sunbeam White	▷ B912	SEE STANDARD COLOURS
NC 700X (12 > 13) / NC 750 X (14)	Pearl Sunbeam White	▷ B912	SEE STANDARD COLOURS
XL 700V Transalp (08 > 13)	Moody Blue Met.	▷ B529	K35 ↘
	Carnelian Red Metallic	▷ R301	SEE STANDARD COLOURS
Crossrunner 800 (11 > 14)	Graphite Black	▷ N902	SEE STANDARD COLOURS
VFR 800 VTEC (02 > 11)	Candy Glory Red	▷ R301	SEE STANDARD COLOURS
	Bright Black	▷ N902	SEE STANDARD COLOURS
	Force Silver Met.	▷ G730	SEE STANDARD COLOURS
	Pearl Sunbeam White	▷ B912	SEE STANDARD COLOURS
VFR 800 F (14)	Candy Glory Red	▷ R301	SEE STANDARD COLOURS
	Bright Black	▷ N902	SEE STANDARD COLOURS
	Force Silver Met.	▷ G730	SEE STANDARD COLOURS
	Pearl Sunbeam White	▷ B912	SEE STANDARD COLOURS
CB 900 Hornet (02 > 07)	Bright Black	▷ N902	SEE STANDARD COLOURS
	Candy Tahitian Blue	▶ B529	K35 ↘

HONDA

MODEL-C.C. - YEAR	COLOUR	CODE	TOP-CASE
	Candy Glory Red	▷ R301	SEE STANDARD COLOURS
CB 1000 R (08 > 14)	Pearl Cool White	▷ B912	SEE STANDARD COLOURS
CBF 1000 / ABS (06 > 09)	Candy Xenon Blue	▷ B529	K35 ↘
	Pearl Cool White	▷ B912	SEE STANDARD COLOURS
CBF 1000 / CBF 1000 ST (10 > 14)	Pearl Cool White	▷ B912	SEE STANDARD COLOURS
	Candy Xenon Blue	▷ B529	K35 ↘
XL 1000V Varadero (99 > 02)	Candy Tahitian Blue	▶ B529	K35 ↘
XL 1000V Varadero ABS (02)	Candy Tahitian Blue	▶ B529	K35 ↘
XL 1000V Varadero / ABS (03 > 06)	Candy Tahitian Blue	▶ B529	K35 ↘
	Shield Silver Met.	▷ G730	SEE STANDARD COLOURS
	Mute Black Met.	▷ N902	SEE STANDARD COLOURS
XL 1000V Varadero / ABS (07 > 12)	Candy Tahitian Blue	▶ B529	K35 ↘
CB 1100 (13)	Pearl Cool White	▷ B912	SEE STANDARD COLOURS
CBR 1100 XX (97 > 09)	Candy Tahitian Blue	▶ B529	K35 ↘
	Accurate Silver Met.	▷ G730	SEE STANDARD COLOURS
X-11 1100 (00 > 03)	Bright Black	▷ N902	SEE STANDARD COLOURS
	Candy Tahitian Blue	▶ B529	K35 ↘
Crosstourer 1200 (12 > 14)	Pearl Sunbeam White	▷ B912	SEE STANDARD COLOURS
VFR 1200 F (10 > 14)	Pearl Sunbeam White	▷ B912	SEE STANDARD COLOURS
CB 1300 / CB 1300 S (03 > 09)	Force Silver Met.	▷ G730	SEE STANDARD COLOURS
	Pearl Sunbeam White	▷ B912	SEE STANDARD COLOURS
CB 1300 S (10 > 14)	Pearl Sunbeam White	▷ B912	SEE STANDARD COLOURS

KAWASAKI

MODEL-C.C. - YEAR	COLOUR	CODE	TOP-CASE
Versys 650 (06 > 09)	Ebony Black	▷ N902	SEE STANDARD COLOURS
Z 750 (07 > 13)	Ebony Black	▷ N902	SEE STANDARD COLOURS
Z 1000 (07 > 09)	Ebony Black	▷ N902	SEE STANDARD COLOURS

KYMCO

MODEL-C.C. - YEAR	COLOUR	CODE	TOP-CASE
Aglity 50-125-150-200 R16 (08 > 13)	Azzurro Maniva	▶ B600	KC30 ↘
	Nero Maggiore	▷ N902	SEE STANDARD COLOURS
B&W 50 (04 > 06)	Argento Metallizzato	▷ G730	SEE STANDARD COLOURS
Dink 50-125-200 i (06 > 14)	Argento Gavia	▶ G777	KC30 ↘ K35 ↘
	Azzurro Maniva	▶ B600	KC30 ↘
	Argento Metallizzato	▷ G730	SEE STANDARD COLOURS
Dink Classic 50 (03)	Argento Metallizzato	▷ G730	SEE STANDARD COLOURS
Dink Classic 50 (04 > 06)	Argento Metallizzato	▷ G730	SEE STANDARD COLOURS
People 50-125-150 (05 > 06)	Argento Metallizzato	▷ G730	SEE STANDARD COLOURS
People 50-125 (08)	Argento Metallizzato	▷ G730	SEE STANDARD COLOURS
People S 50-125-200 (05 > 14)	Argento Metallizzato	▷ G730	SEE STANDARD COLOURS
	Nero Maggiore	▷ N902	SEE STANDARD COLOURS
	Azzurro Maniva	▶ B600	KC30 ↘
Downtown 125i-200i-300i (09 > 14)	Argento Metallizzato	▷ G730	SEE STANDARD COLOURS
Dink Classic 125-150 (97 > 06)	Argento Metallizzato	▷ G730	SEE STANDARD COLOURS
Grand Dink 125-150-250 (00 > 07)	Argento Metallizzato	▷ G730	SEE STANDARD COLOURS
Movie XL 125-150 (02 > 09)	Argento Metallizzato	▷ G730	SEE STANDARD COLOURS
People GTi 125-200-300 (10 > 14)	Argento Metallizzato	▷ G730	SEE STANDARD COLOURS
	Nero Maggiore	▷ N902	SEE STANDARD COLOURS
Dink Classic 200 (04 > 06)	Argento Metallizzato	▷ G730	SEE STANDARD COLOURS

**ATTENTION: THE AVAILABILITY OF SPECIFIC COLOURS FOR THE PAINTED CASE IS SUBJECT TO THE MARKET DEMAND.

(↘) AVAILABLE TILL STOCK ENDS

(▶) ORIGINAL COLOUR

(▷) ADAPTABLE COLOUR



KYMCO

MODEL-C.C. - YEAR	COLOUR	CODE	TOP-CASE
B&W 250 (01 > 06)	Argento Metallizzato	▷ G730	SEE STANDARD COLOURS
People 250 (04 > 05)	Argento Metallizzato	▷ G730	SEE STANDARD COLOURS
People S 250 (06 > 10)	Argento Metallizzato	▷ G730	SEE STANDARD COLOURS
	Nero Maggiore	▷ N902	SEE STANDARD COLOURS
	Azzurro Maniva	▶ B600	KC30 ↘
Xciting 250-300-500 (05 > 09)	Argento Metallizzato	▷ G730	SEE STANDARD COLOURS
Xciting 300i-500i R (09 > 14)	Argento Metallizzato	▷ G730	SEE STANDARD COLOURS
Myroad 700 (11 > 14)	Argento Metallizzato	▷ G730	SEE STANDARD COLOURS

MBK

MODEL-C.C. - YEAR	COLOUR	CODE	TOP-CASE
Skycruiser 125 (10 > 12)	Competition White	▷ B912	SEE STANDARD COLOURS

PIAGGIO

MODEL-C.C. - YEAR	COLOUR	CODE	TOP-CASE
Zip 50 2T / 50 4T (05 > 09)	Nero Lucido	▷ N902	SEE STANDARD COLOURS
Zip 50 2T / 50 4T (13 > 14)	Nero Lucido	▷ N902	SEE STANDARD COLOURS
New Fly 50-125 (12 > 14)	Nero Lucido	▷ N902	SEE STANDARD COLOURS
	Blue Midnight	▶ B588	K35 ↘
Vespa Primavera 50-125 (14)	Bright Black	▷ N902	SEE STANDARD COLOURS
Fly 50-100-125-150 (04 > 14)	Nero Lucido	▷ N902	SEE STANDARD COLOURS
	Blue Midnight	▶ B588	K35 ↘
Liberty 50-125-150 (09 > 14)	Nero Cosmo	▶ N931	K35 ↘
	Blue Midnight	▶ B588	K35 ↘
	Grigio Pulsar	▷ G730	SEE STANDARD COLOURS
Liberty 50 4T / 125 4T / 150 4T (02 > 03)	Blue Midnight	▶ B588	K35 ↘
	Grigio Pulsar	▷ G730	SEE STANDARD COLOURS
	Bright Black	▷ N902	SEE STANDARD COLOURS
Liberty 50 4T / 50 2T / 125 4T / 150 4T (09)	Nero Cosmo	▶ N931	K35 ↘
	Blue Midnight	▶ B588	K35 ↘
	Grigio Pulsar	▷ G730	SEE STANDARD COLOURS
	Bianco Perla	▷ B912	SEE STANDARD COLOURS
Vespa GTS 125 (05 > 08)	Nero Lucido	▷ N902	SEE STANDARD COLOURS
	Blue Midnight	▶ B588	K35 ↘
Vespa LX 50-125-150 (05 > 14)	Blue Midnight	▶ B588	K35 ↘
Vespa S 50-125-150 (07 > 14)	Nero Lucido	▷ N902	SEE STANDARD COLOURS
Vespa ET2-ET4 125-150 (07/97 > 02)	Bright Black	▷ N902	SEE STANDARD COLOURS
Vespa ET4 125-150 (03 > 05)	Bright Black	▷ N902	SEE STANDARD COLOURS
Vespa PX 125-150 (08)	Nero Lucido	▷ N902	SEE STANDARD COLOURS
	Blue Midnight	▶ B588	K35 ↘
Vespa PX 125-150 (04 > 06)	Nero Lucido	▷ N902	SEE STANDARD COLOURS
	Blue Midnight	▶ B588	K35 ↘
Super Hexagon 125-180-250 (01 > 03)	Bright Black	▷ N902	SEE STANDARD COLOURS
X9 125-180-250 (00 > 02)	Bright Black	▷ N902	SEE STANDARD COLOURS
Beverly 125-200 (01 > 04)	Bright Black	▷ N902	SEE STANDARD COLOURS
Vespa 125-200 granturismo (03 > 08)	Bright Black	▷ N902	SEE STANDARD COLOURS
	Blue Midnight	▶ B588	K35 ↘
Carnaby 125-200 (07 > 11)	Grigio Pulsar	▷ G730	SEE STANDARD COLOURS
	Blue Midnight	▶ B588	K35 ↘
	Nero Cosmo	▶ N931	K35 ↘
Vespa GTS 125-250 (06 > 14)	Nero Lucido	▷ N902	SEE STANDARD COLOURS

PIAGGIO

MODEL-C.C. - YEAR	COLOUR	CODE	TOP-CASE
	Blue Midnight	▶ B588	K35 ↘
X7 125-250 (08 > 11)	Grigio Pulsar	▷ G730	SEE STANDARD COLOURS
	Nero Lucido	▷ N902	SEE STANDARD COLOURS
	Blue Midnight	▶ B588	K35 ↘
X8 125-150-200-250-400 (04 > 10)	Bright Black	▷ N902	SEE STANDARD COLOURS
	Blue Midnight	▶ B588	K35 ↘
Mp3 Yourban 125-300 (11 > 14)	Nero Cosmo	▶ N931	K35 ↘
Vespa GTS 125-300 Super (08 > 14)	Nero Lucido	▷ N902	SEE STANDARD COLOURS
X7 EVO 125i-300i (09 > 14)	Grigio Pulsar	▷ G730	SEE STANDARD COLOURS
	Nero Cosmo	▶ N931	K35 ↘
Beverly 125-250ie-400ie (08)	Blue Midnight	▶ B588	K35 ↘
Beverly 125-250-400 (04 > 07)	Bright Black	▷ N902	SEE STANDARD COLOURS
	Blue Midnight	▶ B588	K35 ↘
Beverly Tourer 125-250-300-400 (08 > 10)	Blue Midnight	▶ B588	K35 ↘
	Grigio Pulsar	▷ G730	SEE STANDARD COLOURS
	Nero Demon	▶ N931	K35 ↘
Beverly 125ie-300ie (10 > 14) / Beverly 250 Sport Touring (12 > 14)	Nero Cosmo	▶ N931	K35 ↘
	Blue Midnight	▶ B588	K35 ↘
	Bronzo Perseo	▶ G125	K35 ↘
	Rosso Antares	▷ R301	SEE STANDARD COLOURS
Mp3 125 / 250 / 300 / 400 (06 > 11)	Blue Midnight	▶ B588	K35 ↘
	Grigio Pulsar	▷ G730	SEE STANDARD COLOURS
	Nero Cosmo	▶ N931	K35 ↘
Skipper ST (04)	Bright Black	▷ N902	SEE STANDARD COLOURS
Vespa GTS 250 (05)	Nero Lucido	▷ N902	SEE STANDARD COLOURS
X9 (03 > 07)	Blue Midnight	▶ B588	K35 ↘
	Bright Black	▷ N902	SEE STANDARD COLOURS
X10 125-350-500 (12 > 14)	Blue Midnight	▶ B588	K35 ↘
	Bright Black	▷ N902	SEE STANDARD COLOURS
	Nero Cosmo	▶ N931	K35 ↘
Liberty 200 4T (04 > 06)	Bright Black	▷ N902	SEE STANDARD COLOURS
	Grigio Pulsar	▷ G730	SEE STANDARD COLOURS
	Blue Midnight	▶ B588	K35 ↘
X9 200-250-500 Evolution (03 > 08)	Bright Black	▷ N902	SEE STANDARD COLOURS
	Blue Midnight	▶ B588	K35 ↘
Beverly Cruiser 250 - 500 (07 > 11)	Blue Midnight	▶ B588	K35 ↘
	Nero Lucido	▷ N902	SEE STANDARD COLOURS
Carnaby Cruiser 300 (09 > 12)	Nero Cosmo	▶ N931	K35 ↘
	Bronzo Perseo	▶ G125	K35 ↘
Beverly 500 (03 > 07)	Bright Black	▷ N902	SEE STANDARD COLOURS
	Blue Midnight	▶ B588	K35 ↘
X9 500 (01 > 02)	Bright Black	▷ N902	SEE STANDARD COLOURS

SUZUKI

MODEL-C.C. - YEAR	COLOUR	CODE	TOP-CASE
Epicuro 125-150 (02 > 03)	Sonic Silver Metallic	▷ G730	SEE STANDARD COLOURS
Sixteen 125-150 (08 > 14)	Pearl Vigor Blue	▷ B529	K35 ↘
	Bianco	▷ B912	SEE STANDARD COLOURS
	Sonic Silver Metallic	▷ G730	SEE STANDARD COLOURS
	Pearl Glass White	▷ B915	KC49 ↘
UH 125-150 Burgman (02 > 06)	Sonic Silver Metallic	▷ G730	SEE STANDARD COLOURS
	Black Met.	▷ N901	SEE STANDARD COLOURS
UH 125-150 Burgman (06 > 07)	Sonic Silver Metallic	▷ G730	SEE STANDARD COLOURS

MOTORCYCLE ACCESSORIES

SUZUKI

MODEL-C.C. - YEAR	COLOUR	CODE	TOP-CASE
	Black Met.	▷ N901	SEE STANDARD COLOURS
UH 125-200 Burgman (07 > 09)	Sonic Silver Metallic	▷ G730	SEE STANDARD COLOURS
	Nero	▷ N902	SEE STANDARD COLOURS
	Bianco	▷ B912	SEE STANDARD COLOURS
AN 250-400 Burgman (98 > 02)	Sonic Silver Metallic	▷ G730	SEE STANDARD COLOURS
AN 250 Burgman (03 > 05)	Sonic Silver Metallic	▷ G730	SEE STANDARD COLOURS
AN 250-400 Business (01 > 03)	Sonic Silver Metallic	▷ G730	SEE STANDARD COLOURS
AN 250-400 Burgman (03 > 06)	Pearl Nebular Black	▷ N902	SEE STANDARD COLOURS
	Sonic Silver Metallic	▷ G730	SEE STANDARD COLOURS
Inazuma 250 (12 > 14)	Pearl Nebular Black	▷ N902	SEE STANDARD COLOURS
	Sonic Silver Metallic	▷ G730	SEE STANDARD COLOURS
AN 400 Burgman (07 > 09)	Rosso	▷ R301	SEE STANDARD COLOURS
	Pearl Nebular Black	▷ N902	SEE STANDARD COLOURS
	Bianco	▶ B915	KC49 ↘
Burgman 400 K7-K8-K9-L0-L1-L2 (06 > 14)	Red	▷ R301	SEE STANDARD COLOURS
	Pearl Nebular Black	▷ N902	SEE STANDARD COLOURS
	Bianco	▶ B915	KC49 ↘
GS 500 E (01 > 07) / GS 500 F (04)	Black Met.	▷ N901	SEE STANDARD COLOURS
GS 500 E (05)	Black Met.	▷ N901	SEE STANDARD COLOURS
GSF 600 Bandit / S (00 > 04)	Sonic Silver Metallic	▷ G730	SEE STANDARD COLOURS
	Black Met.	▷ N901	SEE STANDARD COLOURS
	Red Met.	▷ R301	SEE STANDARD COLOURS
GSR 600 (06 > 11)	Silver	▷ G730	SEE STANDARD COLOURS
	Pearl Nebular Black	▷ N902	SEE STANDARD COLOURS
	Bianco	▶ B915	KC49 ↘
AN 650 Burgman Executive (02 > 12)	Sonic Silver Metallic	▷ G730	SEE STANDARD COLOURS
	Bianco	▶ B915	KC49 ↘
	Nero	▷ N902	SEE STANDARD COLOURS
650 Burgman / 650 Burgman Executive (13 > 14)	Nero	▷ N902	SEE STANDARD COLOURS
DL 650 V-Strom (04 > 11)	Blu	▷ B529	K35 ↘
	Sonic Silver Metallic	▷ G730	SEE STANDARD COLOURS
	Pearl Nebular Black	▷ N902	SEE STANDARD COLOURS
	Bianco	▶ B915	KC49 ↘
DL 650 V-Strom L2-L3 (11 > 14)	Bianco	▶ B915	KC49 ↘
Gladius 650 (09 > 14)	Nero	▷ N902	SEE STANDARD COLOURS
	Bianco	▶ B915	KC49 ↘
GSF 650 Bandit / Bandit S / Bandit ABS (05 > 06)	Pearl Nebular Black	▷ N902	SEE STANDARD COLOURS
	Sonic Silver Metallic	▷ G730	SEE STANDARD COLOURS
GSF 650 Bandit / GSF 650 Bandit S K7-K8 (07 > 11)	Blu	▷ B529	K35 ↘
	Pearl Nebular Black	▷ N902	SEE STANDARD COLOURS
	Red	▷ R301	SEE STANDARD COLOURS
GSF 650 BANDIT / GSF BANDIT S K9-L0-L1-L2 (09 > 14)	Pearl Nebular Black	▷ N902	SEE STANDARD COLOURS
GSX 650 F (08 > 14) / GSX 1250 F (10 > 14)	Nero	▷ N902	SEE STANDARD COLOURS
SV 650 / SV 650 S (99 > 02)	Sonic Silver Metallic	▷ G730	SEE STANDARD COLOURS
SV 650 / SV 650 S (03 > 08)	Sonic Silver Metallic	▷ G730	SEE STANDARD COLOURS
	Black Met.	▷ N901	SEE STANDARD COLOURS
	Pearl Nebular Black	▷ N902	SEE STANDARD COLOURS
GSX 750 (98 > 02)	Black Met.	▷ N901	SEE STANDARD COLOURS
	Red Met.	▷ R301	SEE STANDARD COLOURS
GSX 750 (03)	Black Met.	▷ N901	SEE STANDARD COLOURS
	Red	▷ R301	SEE STANDARD COLOURS
DL 1000 V-Strom (02 > 11)	Sonic Silver Metallic	▷ G730	SEE STANDARD COLOURS
	Pearl Nebular Black	▷ N902	SEE STANDARD COLOURS
DL 1000 V-Strom (14)	Sonic Silver Metallic	▷ G730	SEE STANDARD COLOURS
	Pearl Nebular Black	▷ N902	SEE STANDARD COLOURS
SV 1000 / SV 1000 S (03 > 07)	Sonic Silver Metallic	▷ G730	SEE STANDARD COLOURS

SUZUKI

MODEL-C.C. - YEAR	COLOUR	CODE	TOP-CASE
	Pearl Nebular Black	▷ N902	SEE STANDARD COLOURS
GSF 1200 Bandit / Bandit S (00 > 05)	Sonic Silver Metallic	▷ G730	SEE STANDARD COLOURS
	Black Met.	▷ N901	SEE STANDARD COLOURS
	Pearl Nebular Black	▷ N902	SEE STANDARD COLOURS
GSF 1200 Bandit / Bandit S (06)	Pearl Nebular Black	▷ N902	SEE STANDARD COLOURS
GSF 1250 Bandit / Bandit S (07 > 11)	Rosso	▷ R301	SEE STANDARD COLOURS
	Pearl Nebular Black	▷ N902	SEE STANDARD COLOURS

SYM

MODEL-C.C. - YEAR	COLOUR	CODE	TOP-CASE
Mio 50-100 (09)	Bianco / Arancio	▶ A207	KC30 ↘
Symphony 50-125-151 (09 > 14)	Nero	▷ N902	SEE STANDARD COLOURS

YAMAHA

MODEL-C.C. - YEAR	COLOUR	CODE	TOP-CASE
BW'S 50 (05 > 14)	Competition White	▷ B912	SEE STANDARD COLOURS
Neo's 50 (08 > 14)	Competition White	▷ B912	SEE STANDARD COLOURS
Cignus X 125 (07 > 14)	Competition White	▷ B912	SEE STANDARD COLOURS
Vity 125 (10 > 14)	Competition White	▷ B912	SEE STANDARD COLOURS
YP 125/180 Majesty (07 > 09)	Fine Silver	▷ G730	SEE STANDARD COLOURS
X-CITY 125-250 (07 > 14)	Competition White	▷ B912	SEE STANDARD COLOURS
	Fine Silver	▷ G730	SEE STANDARD COLOURS
X-MAX 125-250 (05 > 09)	Competition White	▷ B912	SEE STANDARD COLOURS
X-MAX 125-250 (10 > 13)	Competition White	▷ B912	SEE STANDARD COLOURS
Majesty 250 (00 > 07)	Marble Silver	▶ G724	KC49 ↘
	Performance Red	▷ R301	SEE STANDARD COLOURS
Majesty 400 (09 > 14)	Competition White	▷ B912	SEE STANDARD COLOURS
X-MAX 400 (13 > 14)	Competition White	▷ B912	SEE STANDARD COLOURS
T-MAX 500 (01 > 07)	Performance Red	▷ R301	SEE STANDARD COLOURS
	Yamaha Blue	▷ B550	K48 ↘
	Silver Metallic	▷ G730	SEE STANDARD COLOURS
T-MAX 500 (08 > 11)	Competition White	▷ B912	SEE STANDARD COLOURS
T-MAX 530 (12 > 14)	Competition White	▷ B912	SEE STANDARD COLOURS
FZ6/FZ6 600 Fazer (04 > 06)	Yamaha Blue	▷ B550	K48 ↘
FZ6 S2 / FZ6 600 Fazer S2 (07 > 11)	Yamaha Blue	▷ B550	K48 ↘
	Silver Metallic	▷ G730	SEE STANDARD COLOURS
XJ 600 (13 > 14)	Competition White	▷ B912	SEE STANDARD COLOURS
XJ6 (09 > 12) / XJ6 Diversion / XJ6 Diversion F 600 (09 > 13)	Competition White	▷ B912	SEE STANDARD COLOURS
XJ6 600 (13)	Competition White	▷ B912	SEE STANDARD COLOURS
MT-03 (06 > 14)	Competition White	▷ B912	SEE STANDARD COLOURS
XT 660Z Teneré (08 > 14)	Competition White	▷ B912	SEE STANDARD COLOURS
FZ8 / Fazer 8 800 (10 > 14)	Competition White	▷ B912	SEE STANDARD COLOURS
FZ1 1000 (06 > 14)	Competition White	▷ B912	SEE STANDARD COLOURS
FZS 1000 Fazer (01 > 02)	Yamaha Blue	▷ B550	K48 ↘
FZ1 1000 Fazer (06 > 14)	Competition White	▷ B912	SEE STANDARD COLOURS
BT 1100 Bulldog (02 > 09)	Yamaha Blue	▷ B550	K48 ↘
XT1200Z Superteneré (10 > 14)	Competition White	▷ B912	SEE STANDARD COLOURS
XJR 1300 (98 > 02)	Yamaha Blue	▷ B550	K48 ↘
XJR 1300 (03)	Yamaha Blue	▷ B550	K48 ↘
XJR 1300 (07 > 14)	Competition White	▷ B912	SEE STANDARD COLOURS

**ATTENTION: THE AVAILABILITY OF SPECIFIC COLOURS FOR THE PAINTED CASE IS SUBJECT TO THE MARKET DEMAND.

(↘) AVAILABLE TILL STOCK ENDS

(▶) ORIGINAL COLOUR

(▷) ADAPTABLE COLOUR



SOFT LUGGAGE

RACER RANGE



With its 11 models, the RACER represents the most complete soft bag range in the KAPPA catalogue. Characterizing the range there are high quality materials (Polyester 840D, and Polyestere 1200D textured with inserts in eco-leather and EVA laminate) and a realization without compromise and very accurate even in the small details.

The range includes every kind of bag, from the classic bags for luggage, with capacity from 5 to 37 liters, all provided with rain covers in high visibility color (taking advantage for the safety), and other compact containers for specific accessories.

The Races line allows you to use at best every available space of your 2 wheels vehicle.

LIGHT RANGE



This KAPPA range is the most interesting in price-quality ratio. The models included in the range are now six, made of Polyester 420D or Nylon 840D plus finishes in reflective material and with an high versatility. Rain covers included.

DRY PACK RANGE



The range is characterized by a set of 100% waterproof bags, guaranteed from a high frequency seam process and from the use of electromagnetic waves, that give durability and resistance.

Common characteristics: PVC Tarpaulin 500d type material, that guarantees a good balance between strength and ductility.

Bending tight the opening of the bags, for three times on itself, it creates a hermetic seal that doesn't permit the entrance of the water, and is called the roll-top system.

CUSTOM QUALITY RANGE



In order to satisfy the custom and cruiser motorcycle riders, Kappa has introduced a new range of bags, made in buffalo leather.

MOTORCYCLE ACCESSORIES

RACER RANGE



RA300



RA301



RA302



RA303



RA304



RA305R **NEW**



RA306



RA307R



RA308



RA309



RA310



RA311 **NEW**

RA300 - TANK BAG

RA300

Tail pack with a large central compartment, comfortable external pockets and a practical padded area, that can be used as a backrest for the passenger's comfort.
Material: 840D Polyester + 1200D textured Polyester with inserts in simulated leather and EVA finishing.
Mounting kit: kit of elastic straps for the anchorage to the bike

SPARE PARTS

TK708R ↘

Rain cover

TK711FE ↘

Fastening elastic belts (2 pcs.)



TECH INFO



↘ = Item available until it runs out of stock

RA301 - TANK BAG

RA301 Expandable tank bag with extractable magnets. Equipped with transparent phone holder, pay toll device holder, fluorescent orange rain cover, shoulder belt and safety belt for the anchorage to the handlebar.
Compatible with the universal Tanky base TKB00.
Material: 840D Polyester + 1200D textured Polyester with inserts in simulated leather and EVA finishing.
Mounting kit: straps for the Tanky base TKB00/adjustable belts for non-metallic tanks/ magnets



TECH INFO



SPARE PARTS

- TK718A** ↘ Adjustable fastening belts (of 2 pcs.)
- TK724A** ↘ Adjustable fastening belts
- TK707B** ↘ Shoulder belt
- TK709B** ↘ Shoulder belt



compatible with the Tanky base TKB00



RA302 - TANK BAG

RA302 Expandable tank bag with extractable magnets. Fluorescent orange rain cover, divisible rain cover and safety belt for the anchorage to the handlebar. It can be transformed into a rucksack.
Material: 840D Polyester + 1200D textured Polyester with inserts in simulated leather and EVA finishing.
Mounting kit: foldable straps for the Tanky base TKB00/adjustable belts for non-metallic tanks/ magnets



TECH INFO



SPARE PARTS

- TK724A** ↘ Adjustable fastening belts
- TK707B** ↘ Shoulder belt
- TK711R** ↘ Rain cover
- TK733R** ↘ Rain cover



compatible with the Tanky base TKB00



MOTORCYCLE ACCESSORIES

RA303 - SADDLE BAGS

RA303

Pair of expandable side bags with "fire-retardant" base that contrasts the close position to the exhaust pipe. Equipped with shoulder belt for comfortable carrying and front pockets. Equipped with fluorescent orange rain cover. Material: 840D Polyester + 1200D textured Polyester with inserts in simulated leather and EVA finishing. Mounting kit: 3 fastening belts, two with Velcro and one central for the safety and two elastic straps with hook.



SPARE PARTS

- TK706B** ↘ Shoulder belt
- TK712B** ↘ Shoulder belt
- TK706FE** ↘ Fastening elastic belts
- TK711FE** ↘ Fastening elastic belts (2 pcs.)



TECH INFO



SOFT BAGS

RA304 - TAIL BAG

RA304

Tail pack, equipped with double opening, central and side opening, carry handle and shoulder strap for easy carrying. Waterproof cover included. Material: 840D Polyester + 1200D textured Polyester with inserts in simulated leather and EVA finishing. Mounting kit: 2 elastic straps for attaching the bag to the bike.



SPARE PARTS

- TK710B** ↘ Shoulder belt
- TK710FE** ↘ Fastening elastic belts

TECH INFO



↘ = Item available until it runs out of stock

RA305R - MAP HOLDER

RA305R

Compact GPS system carrier, that can be adapted to the majority of GPS devices and to the most types of mobile phones equipped with navigation software. Waterproof zippers and waterproof cover included. Material: polyester 1680D with finishes in syn leather and silver metallic net. Mounting kit: adjustable and universal Velcro straps for attaching the carrier to the bike or scooters.



TECH INFO



RA306 - WAIST BAG

RA306

Pouch with five pockets. Material: polyester 840D and simulated leather.



TECH INFO



RA307R - LEG BAG

RA307R

Practical small leg bag, that can be attached to the leg and it can contain the indispensable objects without being cumbersome during the drive.

Material: 840D Polyester + 1200D textured Polyester with inserts in simulated leather and EVA finishing.



TECH INFO



MOTORCYCLE ACCESSORIES

RA308 - TANKLOCK BAG

RA308

Expandable tank bag with Tanklock System, can be fitted only if combined with the specific flanges BF__K to be fixed to the fuel cap, which in turn is fastened to the system mounted on the bottom of the bag with a simple click. Equipped with transparent map holder, fluorescent orange rain cover and shoulder belt.
Material: 840D Polyester + 1200D textured Polyester with inserts in simulated leather and EVA finishing.
Fitting kit: the Tanklock system and the safety belt for the anchorage to the handlebar



SPARE PARTS

TK724A ↘	Adjustable fastening belts
TK707B ↘	Shoulder belt
TK708R ↘	Rain cover
ZT480F	Nylon flange for fixing the bags
ZT480R	Replacement flange

TECH INFO



SOFT BAGS

RA309 - TANKLOCK BAG

RA309

Tank bag with Tanklock System, can be fitted only if combined with the specific flanges BF__K to be fixed to the fuel cap, which in turn is fastened to the system mounted on the bottom of the bag with a simple click. Equipped with transparent phone pocket, fluorescent orange rain cover and shoulder belt.
Material: 840D Polyester + 1200D textured Polyester with inserts in simulated leather and EVA finishing.
Fitting kit: the Tanklock system and the safety belt for the anchorage to the handlebar



SPARE PARTS

TK724A ↘	Adjustable fastening belts
TK707B ↘	Shoulder belt

TECH INFO



↘ = Item available until it runs out of stock

RA310 - SADDLE BAGS

RA310

Pair of expandable side bags, with "fire retardant" base, that contrasts the close position to the exhaust pipe. Equipped with shoulder strap for a comfortable carrying and side pocket for the can. Equipped with fluorescent rain cover.

Material: 840D with inserts in simulated leather and frontal pocket in EVA finishing.

Fitting kit: fastening belts, two with Velcro and one central for the safety and two elastic straps with hook.



SPARE PARTS

TK706B ↘	Shoulder belt
TK712B ↘	Shoulder belt
TK706R ↘	Rain cover
TK736R ↘	Rain cover
TK706FE ↘	Fastening elastic belts
TK711FE ↘	Fastening elastic belts (2 pcs.)

TECH INFO



RA311 - TANKLOCK BAG

RA311

Expandable tank bag with Tanklock System, can be fitted only if combined with the specific flanges (BF__K) to be fixed to the fuel cap, which in turn is fastened to the system mounted on the bottom of the bag with a simple click.

Equipped with fluorescent and reflective inserts for better visibility, two side pockets, top pocket for smartphone, transparent map holder, waterproof cover and shoulder strap.

Material: Polyester 1840D with finishings in syn leather and Polypropylene.

CHECK THE FLANGE COMPATIBLE WITH THE MODEL OF YOUR BIKE IN ENCLOSED PDF



TECH INFO



MOTORCYCLE ACCESSORIES



RA308



RA309



RA311

Tank bag with Tanklock System, can be fitted only if combined with the specific flanges BF__K to be fixed to the fuel cap, which in turn is fastened to the system mounted on the bottom of the bag with a simple click. Therefore fast locking and unlocking offering ultimate convenience when you fill up or you stop for a quick break.

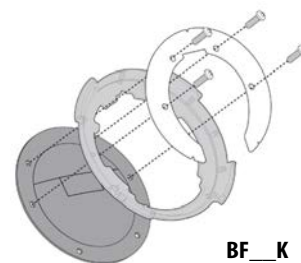

BF__K

TANKLOCK SYSTEM



*Pull to remove

MODELLO - CC. - ANNO MODEL - CC. - YEAR	FLANGIA FLANGE	MODELLO - CC. - ANNO MODEL - CC. - YEAR	FLANGIA FLANGE	MODELLO - CC. - ANNO MODEL - CC. - YEAR	FLANGIA FLANGE
APRILIA		XL 700 V TRANSALP (08 > 13)	BF03K	GSX 1250 F (10 > 14)	BF01K
RS 125	BF02K	VFR 800 F (14)	BF20K	GSX 1300R HAYABUSA (08 > 14)	BF01K
SHIVER 750 / SHIVER GT 750 (07 > 09)	BF02K	VFR 800 VTEC (02 > 11)	BF03K	TRIUMPH	
SHIVER 750 (10 > 14)	BF02K	CBR 1000 RR (08 > 14)	BF03K	STREET TRIPLE 675 (07 > 12)	BF02K
ETV 1000 CAPONORD (01 > 10)	BF02K	CB 1000 R (08 > 13)	BF03K	STREET TRIPLE 675 (13 > 14)	BF02K
BENELLI		CBF 1000 / CBF 1000 ST (10 > 14)	BF03K	Daytona 675	BF02K
BN 600 (13 > 14)	BF02K	CBF 1000 ABS (06 > 09)	BF03K	Tiger 800 / Tiger 800 XC (11 > 14)	BF02K
CAFÈ RACER 899 (10)	BF02K	VFR 1200 F (10 > 14)	BF03K	Tiger Sport 1050 (13 > 14)	BF02K
CAFÈ RACER 1130 (10)	BF02K	CROSSTOURER 1200 (12>13)	BF03K	Speed Triple 1050 (08 > 10)	BF02K
TITANIUM (10)	BF02K	CROSSTOURER 1200 (14)	BF20K	Speed Triple 1050 (11 > 14)	BF02K
TORNADO NAKED TRE 899 (10)	BF02K	CB 1300 S (10 > 14)	BF03K	Sprint ST 1050 (05 > 11)	BF02K
TORNADO NAKED TRE 899S (10)	BF02K	CB 650 F / CBR 650 F (14)	BF20K	Tiger 1050 (07 > 12)	BF02K
TORNADO NAKED TRE R160 (10)	BF02K	KAWASAKI		SPRINT GT 1050 (10 > 14)	BF02K
TRE 899 K / TRE 1130 K (06 > 14)	BF02K	NINJA 300 (13 > 14)	BF14K	Tiger Explorer 1200 (12>14)	BF02K
BMW		ER-6N / ER-6F 650 (05 > 08)	BF04K	YAMAHA	
F650 GS / F700 GS / F800 GS (08 > 14)	BF15K	ER-6N / ER-6F 650 (09 > 11)	BF04K	FZ6/FZ6 600 FAZER (04 > 06)	BF05K
G 650 GS (11 > 14)	BF19K	ER-6N / ER-6F 650 (12>14)	BF04K	FZ6 S2 / FZ6 600 FAZER S2 (07 > 11)	BF05K
F800 GS ADVENTURE (13 > 14)	BF15K	VERSYS 650 (10 > 14)	BF04K	XJ6 (09/12) / XJ6 DIVERSION / XJ6 DIVERSION F 600 (09 > 13)	BF05K
F800 GT (13 > 14)	BF16K	ZX-6R (09 > 12)	BF04K	XJ6 (09>12)	BF05K
F800 R (09 > 14)	BF16K	Z 750 (07 > 13)	BF04K	XJ6 600 (13 > 14)	BF05K
S1000 RR (12 > 14)	BF06K*	Z 800 (13 > 14)	BF04K	YZF R6 (06 > 12)	BF05K
R1150 R (01 > 06)	BF11K	Z 800 (13 > 14)	BF04K	MT 03 (06 > 14)	BF05K
R1200 GS (08)	BF07K*	VERSYS 1000 (12>14)	BF04K	YZF 600 R6 (06 > 07)	BF05K
R1200 GS (09 > 12)	BF13K*	Z1000 (10 > 13)	BF04K	MT-07 (14)	BF21K
R1200 GS (13 > 14)	BF11K	Z1000 SX (11>14)	BF04K	FZ8 / FAZER 8 800 (10 > 14)	BF05K
R1200 GS ADVENTURE (09 > 13)	BF13K*	ZX10R (10 > 12)	BF04K	MT 09 (13 > 14)	BF05K
R1200 GS ADVENTURE (14)	BF17K	KTM		TDM 900 (02 > 14)	BF05K
R1200 R (11 > 14)	BF06K*	DUKE 125 -200 - 390 (11 > 14)	BF12K	FZ1 1000 (06 > 14)	BF05K
K1200 RS (00 > 04)	BF11K	1190 ADVENTURE /ADVENTURE R (13 > 14)	BF11K	FZ1 FAZER 1000 (06 > 14)	BF05K
R1200 NINET (14)	BF13K*	DA ABBINARE SOLO ALLE BORSE XS308 TANKLOCK O XS319 TANKLOCK		YZF R1 1000 (09>12)	BF05K
DA ABBINARE SOLO ALLE BORSE 3D603 TANKLOCK, XS308 O XS319 TANKLOCK		MV AUGUSTA		XT 1200Z SUPER TENERÉ (10 > 14)	BF05K
CAGIVA		BRUTALE 750 - 910 (> 09)	BF05K	XT 1200ZE SUPER TENERÉ (14)	BF05K
MITO 125	BF05K	F4 750-1000	BF05K	FJR 1300 (06 > 14)	BF05K
DUCATI		BRUTALE 675-800 (13)	BF02K	XJR 1300 (07 > 14)	BF05K
MONSTER 696 - 796 - 1100 (08 > 14)	BF09K	RIVALE 800 (13 > 14)	BF02K	SUZUKI	
848 - 1098 - 1198 (07 > 12)	BF08K	SUZUKI		GSR 600 (06 > 11)	BF01K
MONSTER 1100 EVO (11 > 14)	BF09K	GSR 600 (06 > 11)	BF01K	GSR 600 (06 > 11)	BF01K
MONSTER 1200 (14)	BF08K	GSX-R 600/750 (06 > 10)	BF01K	GSX-R 600/750 (06 > 10)	BF01K
MULTISTRADA 1200 (10 > 14)	BF11K	GSX-R 600/750 (06 > 10)	BF01K	GSX 650 F (08 > 13)	BF01K
MONSTER S2R - S4R - S4RS 800-1000 (04>08)	BF08K	GSX 650 F (08 > 13)	BF01K	GLADIUS 650 (09 > 14)	BF01K
HONDA		DL 650 V-STROM (04 > 11)	BF10K	DL 650 V-STROM L2-L3-L4 (11 > 14)	BF01K
HORNET 600 / HORNET 600 ABS (07 > 10)	BF03K	DL 650 V-STROM L2-L3-L4 (11 > 14)	BF01K	GSF 650 BANDIT / GSF 650 BANDIT'S K9-L0-L1-L2-L3 (09 > 14)	BF01K
CBF 600 S/ CBF 600 N (04 > 12)	BF03K	GSF 650 BANDIT / GSF 650 BANDIT'S K9-L0-L1-L2-L3 (09 > 14)	BF01K	GSR 750 (11 > 14)	BF01K
CBR 600 RR (05 > 09)	BF03K	GSR 750 (11 > 14)	BF01K	DL 1000 V-STROM (02 > 11)	BF10K
CBR 600 F (11 > 13)	BF03K	DL 1000 V-STROM (02 > 11)	BF10K	DL 1000 V-STROM (14)	BF18K
HORNET 600 (11 > 13)	BF03K	DL 1000 V-STROM (14)	BF18K	GSX-R1000 (09 > 12)	BF01K
NT 700 DEAUVILLE (06 > 12)	BF03K	GSX-R1000 (09 > 12)	BF01K		

MOTORCYCLE ACCESSORIES

LIGHT RANGE



LH200



LH201



LH202



LH203R



LH204



LH206



LH207



LH208



LH209

LH200 - TANK BAG

LH200

Expandable tank bag, with extractable magnets, with transparent map holder on the upper side and anti-slippery rubber bottom. Equipped with safety belt to be attached to the head stock and removable belts for carrying as a rucksack. Waterproof cover included.
Material: polyester 420D with finishes in reflective material.
Mounting kit: sliding/folding mounting kit for Tank base TKB00 / magnets / adjustable belts for non metallic tanks.

SPARE PARTS

- TK708B ↘ Shoulder belt
- TK708A ↘ Adjustable fastening belts
- TK724A ↘ Adjustable fastening belts



TECH INFO



compatible with the Tanky base TKB00



↘ = Item available until it runs out of stock

LH201 - TANK BAG

LH201

Double tank bag with extractable magnets, formed of 2 parts that can be separated, expandable, with transparent map holder pocket, on the top-side

- Anti-slip bottom
- Security belt to fasten the bag on the steering wheel
- Waterproof zippers

Material: Polyester 420D with finishes in reflective material

Magnets: extractable magnets for metallic tanks

Mounting kit: sliding/folding mounting kit for "Tanky" base TKB00 / adjustable belts for non metallic tanks.



SPARE PARTS

- TK708B** ▾ Shoulder belt
- TK708A** ▾ Adjustable fastening belts
- TK724A** ▾ Adjustable fastening belts
- TK712R** ▾ Rain cover

TECH INFO



compatible with the Tanky base TKB00



LH202 - SADDLE BAGS

Pair of side bags expandable, with "fire retardant" base, that contrasts the close position to the exhaust pipe.

- Mounting kit: adjustable velcro straps and 2 elastic bends for attaching the bag to the bike
- Polyester 420D with finished in 3M reflective material

SPARE PARTS

- TK706B** ▾ Shoulder belt
- TK712B** ▾ Shoulder belt
- TK706R** ▾ Rain cover
- TK736R** ▾ Rain cover
- TK706FE** ▾ Fastening elastic belts (2 pcs.)
- TK711FE** ▾ Fastening elastic belts (2 pcs.)



TECH INFO



MOTORCYCLE ACCESSORIES

LH203R - TAIL BAG

LH203R

Expandable mini tail bag, was created to be combined to the Enduro bikes, equipped with an internal bag to protect useful tools, rain cover, shoulder belt, and with a non slippery rubber bottom that guarantees a secure and stable adherence.
Material: Polyester 420D PVC and inserts in silver reflective material.
Mounting kit: 3 adjustable belts for attaching the bag to the saddle or to the luggage carrier.



TECH INFO



LH204 - MAP HOLDER

LH204

The LH204 is an expandable map holder equipped with internal document holder, a patch pocket, antislip bottom and safety belt to be fastened on the handlebars. The real novelty is the possibility to use the tank bag LH204 as an iPad holder. The top and transparent pocket allows the use of this navigation tool giving access to the touch screen and the guarantee that the Ipad remains protected thanks to the waterproof zippers.
- Magnets: n° 3 extractable magnets for metallic tanks
- Mounting kit: sliding/folding mounting kit for Tank base TKB00 / magnets / adjustable belts for non metallic tanks.
- Anti-slip bottom
- Security belt to fasten the bag on the steering wheel
- Waterproof zippers
- Nylon fabric 840D



TECH INFO



LH208 - HANDLEBAR BAG

LH208

Handlebar bag for the bike. Equipped with waterproof cover. Equipped with belts to become a waist bag.

Material: Polyester 420D PVC and inserts in silver reflective material.



TECH INFO



👉 = Item available until it runs out of stock

LH206 - TANK BAG

LH206 Magnetic tank bag with handle for the carrying and shoulder belt. Map holder pocket with zipper and fluorescent waterproof cover included.
Material: polyester 420D PVC and inserts in silver reflective material.
Mounting kit: 4 magnets

SPARE PARTS

- TK724A** ↘ Adjustable fastening belts
- TK707B** ↘ Shoulder belt
- TK709B** ↘ Shoulder belt



TECH INFO



LH207 - TANK BAG

LH207 Expandable tank bag, with specific base included, created especially for the Enduro bike tank shape.
Equipped with map holder pocket, waterproof cover and with shoulder belt.
Mounting kit: specific base included.
Material: Polyester 420D PVC and inserts in silver reflective material.



compatible with the Tanky base TKB00



TECH INFO



LH209 - LEG BAG

LH209 Leg wallet.
Equipment:
• adjustable waist belt
• adjustable thigh strap
• front pocket with inner compartment for mobile phones and cord outlet

NEW



TECH INFO



MOTORCYCLE ACCESSORIES

DRY PACK RANGE



WA401S

WA402S

WA404S

WA405F

WA406

WA401S - ROLL BAG

WA401S

A very solid rear saddle roll bag (it can be used on a rack if it is enough wide to support it safely) equipped with great loading capacity.

Material: Tarpaulin, sealed with the Seamless Technology (sealed with high frequency).

Mounting kit: elastic in equipment, universal fitting system, equipped with shoulder belt.

All materials are developed in accordance with Reach regulations.



TECH INFO



WA405F - ROLL BAG

WA405F

A very solid rear saddle roll bag (it can be used on a rack if it is enough wide to support it safely) equipped with great loading capacity.

Material: Tarpaulin, sealed with the Seamless Technology (sealed with high frequency).

Mounting kit: elastic in equipment, universal fitting system, equipped with shoulder belt.

All materials are developed in accordance with Reach regulations.



TECH INFO



↘ = Item available until it runs out of stock

WA402S - RUCKSTACK

WA402S

Waterproof rucksack the main compartment part is "welded" to a solid shoulder strap equipped with waste buckle. Removable helmet bag and removable padding for the back lumbar protection. "Roll top" closing system.

Material: Tarpaulin.

All materials are developed in accordance with Reach regulations.



TECH INFO



WA404S - TAIL BAG

WA404S

The waterproof tail bag WA404S can be secured to the back seat of motorcycles, quads and maxiscooter, but easily turns into multi-purpose bag, it can also be taken on the boat, thanks to its comfortable handles and the shoulder strap which is supplied. "Roll-top" closing system.

Material: Tarpaulin, sealed with the Seamless Technology (sealed with high frequency)

Mounting kit: elastic in equipment, universal fitting system. Equipped with shoulder belt.

All materials are developed in accordance with Reach regulations.



TECH INFO



WA406 - CARGO BAG

WA406

Cargo bag

Material: Tarpaulin, sealed with the Seamless Technology (sealed with high frequency)

Mounting kit: elastic belts, universal fitting system.

"Roll-top" closing system.

All materials are developed in accordance with Reach regulations.

NEW



TECH INFO



MOTORCYCLE ACCESSORIES

CUSTOM QUALITY RANGE



CU500

CU503

CU500 - SADDLE BAGS

CU500

Pair of leather side bags for custom bikes
Material: buffalo leather



NEW



TECH INFO



CU503 - HANDLEBAR BAG

CU503

Leather purse handlebar for custom bikes
Material: buffalo leather



NEW



TECH INFO



COMPLEMENTS FOR BAGS

TK4KIT

TK4KIT Magnets kit (including 4 magnets to allow the mounting on metallic tanks)



TKW748

TKW748 Waterproof Map-holder /Tablet-holder. With 4 adjustable belts and hooks to be fixed to the rings on the base of the bags.
Compatible with the following bags:WA403SM, WA403, LH200SM, LH200, LH201SM, LH201, RA302, TKB754, TKB748, TK713, TK708, TK733
Dimensions : (L x H) 30 x 38,5 cm.



TKB00

TKB00 Universal "Tanky" base, adaptable to non-metallic tanks, recommended for naked and sports motorcycle. This base allows the mounting of all Kappa tank bags with a capacity higher than 10 ltrs.



MOTORCYCLE ACCESSORIES

MOUNTING POSSIBILITIES FOR TANK BAGS

FITTING ON NON-METALLIC TANKS BY MEAN OF THE BELTS INCLUDED

1. Bind the belts included to the frame of the motorcycle



2. Fit the other end of the belts to the D-ring rings on the base of the bag



FITTING ON METALLIC TANKS BY MEAN OF THE TK4KIT MAGNETS KIT

1. Insert the 4 magnets in their seats



2. Fit the bag on the motorcycle tank



FITTING ON NON-METALLIC TANKS BY MEAN OF THE TANKY FITTING SYSTEM

1. Fit the Tanky Fitting System on the frame of the motorcycle, through the 4 adjustable belts



2. Fit the bag on the Tanky base through the belts included



MOUNTING POSSIBILITIES FOR SADDLE BAGS

TUBULAR SUPPORT FOR SOFT BAGS

Available for many models of motorcycles and scooters, these tubular supports allows you to improve the stability of the soft bags during the ride, and preventing direct contact with the fairing. These tubular supports provide a valuable support for the two soft bags, also greatly improving the ease of mounting of the same.



TK__ / TE__ K / TUBULAR SIDE HOLDER

In order to facilitate the secure and stable fitting of the universal saddle bags, KAPPA has studied the specific tubular supports for various motorcycle models. The mounting of the tubular supports allows a perfect anchorage of the bags and represents an added warranty by avoiding the unpleasant damages caused by the proximity of the muffler to the bags.

ACCESSORIES

KS110 - POWER SOCKET

KS110 12V Handlebar electrical outlet socket

NEW



KS111 - POWER HUB

KS111 Hub kit for the electrical feed for the tank bags

TO BE SPECIFICALLY COMBINED WITH THE **KS110**

KS111

NEW



KS112 - POWER CONNECTION

KS112 Power Connection kit for the electrical feed to devices fitted directly on the handlebar

TO BE SPECIFICALLY COMBINED WITH THE **KS110**

KS112

NEW



KS180T SCREEN SPOILER

KS180T Universal transparent spoiler mountable to fairings / windscreens; the aluminum fitting kit allows adjust to both height and inclination.

KS180F SCREEN SPOILER

KS180F Universal smoked spoiler mountable to fairings / windscreens; the aluminum fitting kit allows adjust to both height and inclination.

KS180T

NEW



KS180F

NEW



MOTORCYCLE ACCESSORIES

KS900A

KS900A	Universal aluminum handle bar to install GPS holders, smartphone holders, electronic device holders for road use.
01SKIT	Specific kit to mounting the KS900A Smart Bar
02SKIT	Specific kit to mounting the KS900A Smart Bar
03SKIT	Specific kit to mounting the KS900A Smart Bar
04SKIT	Specific kit to mounting the KS900A Smart Bar
05SKIT	Specific kit to mounting the KS900A Smart Bar



MOTORCYCLE MODELS ON WHICH IT IS POSSIBLE TO MOUNT THE SMART BAR (with the specific fitting kit)

APRILIA

Dorsoduro 750 (08 > 14)	01SKIT
Shiver 750 (10 > 14)	01SKIT
Shiver 750 / Shiver GT 750 (07 > 09)	01SKIT
Mana 850 / Mana 850 GT (08 > 14)	01SKIT
Dorsoduro 1200 (13 > 14)	01SKIT
Caponord 1200 (13 > 14)	01SKIT
Tuono V4	01SKIT

BENELLI

BN 600 R (13>14)	03SKIT
650R (12)	03SKIT

BMW

F 650 GS (08 > 14)	01SKIT
G 650 GS (11 > 14)	01SKIT
F 700 GS (13 > 14)	01SKIT
F 800 GS (08 > 14)	01SKIT
F 800 GS Adventure (13 > 14)	01SKIT
F 800 GT (13 > 14)	01SKIT
F 800 R (09 > 14)	01SKIT
R 1200 GS (04 > 12)	01SKIT
R 1200 GS (13 > 14)	01SKIT
R 1200 GS Adventure (06 > 13)	01SKIT
R 1200 GS Adventure (14)	01SKIT
R 1200 R (11 > 14)	04SKIT
R 1200 RT (05 > 13)	04SKIT

DUCATI

Monster 696 / 796 / 1100 (08 > 13)	05SKIT
Monster 695	03SKIT
Monster S2R / S4R / S4RS 800-1000 (04 > 08)	03SKIT
Hypermotard 696-1100 (> 12)	03SKIT
Hyperstrada 821 (13 > 14)	03SKIT

Streetfighter 848-1098 (09 > 13)	04SKIT
Monster 1200 (14)	05SKIT

honda

XL Varadero 125 V (01 > 06)	03SKIT
XL Varadero 125 V (07 > 14)	03SKIT
CB 500 X (13 > 14)	02SKIT
CB 500 F (13 > 14)	02SKIT
Hornet 600 (07 > 10)	02SKIT
Hornet 600 ABS (07 > 10)	02SKIT
Hornet 600 (11 > 13)	02SKIT
CBF 600 S / CBF 600 N (04 > 12)	01SKIT
CTX 700 DCT (14)	01SKIT
NC 700 S (12 > 13) / NC 750 S (14)	02SKIT
NC 700 X (12 > 13) / NC 750 X (14)	02SKIT
Transalp 700 (08 > 13)	03SKIT
VFR 800 F (14)	01SKIT
CBF 1000 / CBF 1000 ST (10 > 14)	02SKIT
CB 1000 R (08 > 14)	04SKIT
CB 1100 (12 > 14)	01SKIT
Crosstourer 1200 (12 > 14)	03SKIT
CTX 1300 (14)	01SKIT

KAWASAKI

ER-6N / ER-6F (09 > 11)	03SKIT
ER-6F / ER-6F (12 > 14)	03SKIT
KLE 500 (91 > 00)	03SKIT
Versys 650 (10 > 14)	03SKIT
W 800 (11 > 14)	02SKIT
Z 800 (13 > 14)	02SKIT
Versys 1000 (12 > 14)	02SKIT

KTM

Duke 125-200-390 (11 > 14)	03SKIT
Duke 690 (12 > 14)	01SKIT

990 Adventure / 990 (03 > 14)	01SKIT
990 SMT (09 > 14)	01SKIT
Super Duke 990	01SKIT
1190 Adventure / 1190 Adventure R (13 > 14)	01SKIT

MOTO GUZZI

Stelvio 1200 (08 > 14)	01SKIT
------------------------	--------

SUZUKI

GSX 650 F (08 > 14)	05SKIT
Gladius 650 (09 > 14)	05SKIT
DL 650 V-Strom (04 > 11)	05SKIT
DL 650 V-Strom L2-L3 (11 > 14)	05SKIT
Bandit GSF-650S (06)	05SKIT
GSF 650 Bandit	05SKIT
GSF 650 Bandit S K9-L0-L1-L2-L3-L4 (09 > 14)	05SKIT
GSR 750 (11 > 14)	05SKIT
DL 1000 V-Strom (14)	02SKIT
GSX 1250 F (10 > 14)	05SKIT
GSF 1250 Bandit / Bandit S (07 > 11)	05SKIT

TRIUMPH

Tiger 800 / Tiger 800 XC (11 > 14)	01SKIT
Tiger Sport 1050 (13 > 14)	01SKIT
Speed Triple 1050 (11 > 14)	04SKIT
Tiger Explorer 1200 (12 > 14)	01SKIT

YAMAHA

WR 250 R	05SKIT
TDM 900 (02 > 14)	05SKIT
FZ8 / Fazer 8 800 (10 > 14)	05SKIT
MT-09 (13 > 14)	01SKIT
XJ6 (09 > 12) / XJ6 Diversion	05SKIT
XJ6 Diversion F 600 (09 > 13)	05SKIT
XJ6 600 (13 > 14)	05SKIT
XT 1200 ZE Super Tenerè (14)	01SKIT
XJR 1300 (07 > 14)	05SKIT

KS952B - KS953B - KS954B

- KS952B** Smart phone / GPS holder for handlebar mounting suitable for screens up to 3.5 inches.
- KS953B** Smart phone / GPS holder for handlebar mounting suitable for screens up to 4.3 inches.
- KS954B** Smart phone / GPS holder for handlebar mounting suitable for screens up to 5 inches. Suitable for Galaxy S2.
- S951KIT2** Universal mounting kit for KS952, KS953, KS954 and KS955 to fit on motorcycles fitted with handlebar risers
- S951BKITR** Spare parts for the fitting system of KS952B, KS953B, KS954B and KS955

NEW



KS955B

- KS955** Smart phone holder for handlebar mounting suitable for I-Phone 5.
- KS955B** Smart phone holder for handlebar mounting suitable for I-Phone 5.
- S951KIT2** Universal mounting kit for KS952, KS953, KS954 and KS955 to fit on motorcycles fitted with handlebar risers
- S951BKITR** Spare parts for the fitting system of KS952B, KS953B, KS954B and KS955

NEW



KS450

- KS450** The kit contains:
 N. 3 x CO2 cans
 N. 1 x Connector complete with valve
 N. 1 x Flexible tube
 N. 1 x Cutter
 N. 5 x Sealing strips
 N. 2 x Specific utensils
 N. 1 x Tube of adhesive

NEW



MANIFOLD PROTECTORS KS280-KS281-KS282

- KS280** Pair of stainless steel universal manifold protectors. Suitable for motorcycle manifolds with a diameter between 32 mm and 42 mm
- KS281** Pair of stainless steel universal manifold protectors. Suitable for motorcycle manifolds with a diameter between 42 mm and 52 mm
- KS282** Pair of stainless steel universal manifold protectors. Suitable for motorcycle manifolds with a diameter between 52 mm and 60 mm



NEW

EX1SRAK-BAG HOLDER

- EX1SRAK** Expandable aluminum bag holder to fit on the aluminium rear supports KRA__.

NEW



MOTORCYCLE ACCESSORIES

KS601

KS601*

A waterproof and removable holder designed for a motorway toll paying device like "TELEPASS". Complete with universal fitting kit, suitable for motorcycle models with round handlebar

TELEPASS IS A REGISTERED TRADEMARK BELONGING TO ATLANTIA AND AUTOSTRADA PER L'ITALIA



KS602

KS602*

A waterproof and removable holder designed for a motorway toll paying device like "TELEPASS". You attach to your motorcycle via adhesive tabs.

TELEPASS IS A REGISTERED TRADEMARK BELONGING TO ATLANTIA AND AUTOSTRADA PER L'ITALIA

SPARE PART

Z1325M

Adhesive base for "TELEPASS" holder (item KS602)

€



KS961

KS961

Electronic device holder for the motorway toll
Dimension: 90 x 55 x 30 mm (l x h x p)



SK215

SK215

Small bag in neoprene for photo-camera



KS201

KS201L

Motorcycle cover

KS201XL

Motorcycle cover



TK25

TK25

Anti-slip net / paint protection for side bags



KS210

KS210 Waterproof saddle cover



KS650

KS650 Child's chair
BEFORE USE, VERIFY THE COUNTRY LEGISLATION REGARDING PILLION PASSENGERS AND ROAD SAFETY

S650KIT Kit with long brackets for KS650 Child's chair
N. 4 LONG BRACKETS FOR THE MOUNTING OF KS650 CHILD'S CHAIR ON SCOOTERS



TK756

TK756 Internal bag for KGR33, KGR46, KGR52, K53, K48, K961, K49, K49NT, K40, K47, K47NT, K47NN, K47B.



TK755

TK755 Pair of internal polyester bags for K33N cases



KS310

KS310 Additional halogen spotlights

SPARE PART

Z2256 Pair of halogen bulbs replacement 12V 55W H3 €



KS220

KS220 Padlock with retractable wire and combination lock

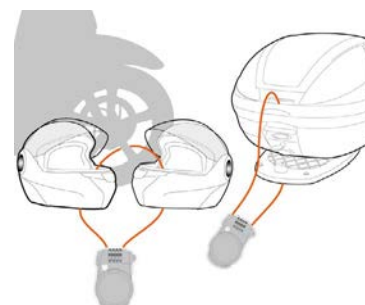

MOTORCYCLE ACCESSORIES

K9910N

K9910N

Elastic carrying net
BLACK COLOUR



KS603

KS603

Pair of hand protectors for motorcycles and
scooters



E125

E125*

Kit of 4 rings for the fitting of the elastic net
K9910N.



TECHNICAL ACCESSORIES

KN ENGINE GUARDS



KNH5114 BMW R1200GS (13>14)



KN51080X BMW R1200GS (13>14)



KNH51100X BMW F800GS Adventure (13>14)



KN5103 BMW F800GS (13>14)



KN1121 Honda CB500X (13)



KN11100X Honda Crosstourer 1200 (12-13)



KN3105 Suzuki DL 1000V-Strom (14)



KN3101 Suzuki DL 650 V-Strom L2-L3 (11>14)



KN7703 KTM 1190 Adventure (13)

MOTORCYCLE ACCESSORIES

KTB BACKRESTS



KTB2111 Yamaha X-Max 400 (13>14)



KTB2013 Yamaha T-Max 530 (12>14)



KTB4111 Kawasaki J300 (14)

RP OIL CARTER PROTECTORS



RP6403 TRIUMPH Tiger Explorer 1200 (12>14)



RP5112 BMW R1200GS (13>14)



RP3105 SUZUKI DL 1000-Vstrom (14) **NEW**

RP5103	BMW F 650 GS / F 800 GS (08 > 14)	
RP5103	BMW F 700 GS (13 > 14)	
RP5103	BMW F 800 GS Adventure (13 > 14)	
RP5112	BMW R 1200 GS (13 > 14)	
RP5112	BMW R 1200 GS Adventure (14)	
RP1110	HONDA Crosstourer 1200 (12 > 14)	

RP7703	KTM 1190 Adventure / 1190 Adventure R (13> 14)	
RP3101	SUZUKI DL 650 V-Strom L2-L3 (11 > 14)	
RP6401	TRIUMPH Tiger 800 / Tiger 800 XC (11 > 14)	
RP6403	TRIUMPH Tiger Explorer 1200 (12 > 14)	
RP2105	YAMAHA XT 660Z Teneré (08 > 14)	
RP2119	YAMAHA XT1200Z Superteneré (10 > 14)	

KMG MUDGUARD / SPECIFIC ABS CHAIN-COVER



KMG3101 SUZUKI DL 650 V-Strom L2-L3 (11 > 14)



KMG1109 HONDA Integra 700 (12 > 13) - HONDA NC700X (12>13)
HONDA NC700S (14) - HONDA NC750X (14)

KMG5103	BMW F 650 GS / F 800 GS (08 > 14)	
KMG5103	BMW F 700 GS (13 > 14)	
KMG1109	HONDA INTEGRA 700 (12 > 13)	
KMG1109	HONDA NC 700S (12 > 13) / NC 750 S (14)	
KMG1109	HONDA NC 700X (12 > 13) / NC 750 X (14)	
KMG4103	KAWASAKI VERSYS 650 (10 > 14)	
KMG532	SUZUKI DL 650 V-STROM (04 > 11)	
KMG3101	SUZUKI DL 650 V-STROM L2-L3 (11 > 14)	
KMG6401	TRIUMPH Tiger 800/800XC (11 > 14)	

ES__K EXTENSION STANDS



ES5108K BMW R1200GS (13>14)



ES7703K KTM Adventure R (13>14)



ES5110K BMW F 650 GS / F 800 GS (08 > 13) / F 700 GS (13) / F 800 GS ADVENTURE (13>14)

ES6706K	APRILIA CAPONORD 1200 (13 > 14)	
ES5110K	BMW F 650 GS / F 800 GS (08 > 14)	
ES5101K	BMW G 650 GS (11 > 14)	
ES5110K	BMW F 800 GS ADVENTURE (13>14)	
ES684K	BMW R 1200 GS (04 > 12)	
ES5108K	BMW R 1200 GS (13>14)	
ES5102K	BMW R 1200 GS ADVENTURE (06 > 13)	
ES5112K	BMW R 1200 GS ADVENTURE (14)	
ES7401K	DUCATI MULTISTRADA 1200 (10 > 14)	
ES1121K	HONDA CB 500 X (13>14)	
ES1121K	HONDA Integra 700 (12 > 13)	
ES1121K	HONDA NC 700S (12 > 13) / NC 750 S (14)	

ES1121K	HONDA XL 700V Transalp (08 > 13)	
ES1121K	HONDA NC 700X (12 > 13) / NC 750 X (14)	
ES1110K	HONDA Crosstourer 1200 (12>14)	
ES4103K	KAWASAKI Versys 650 (10 > 14)	
ES4105K	KAWASAKI Versys 1000 (12 > 14)	
ES7703K	KTM 1190 Adventure / 1190 Adventure R (13 > 14)	
ES3101K	SUZUKI DL 650 V-Strom (04 > 11)	
ES3101K	SUZUKI DL 650 V-Strom L2-L3 (11 > 14)	
ES3105K	SUZUKI DL 1000 V-Strom (14)	
ES6401K	TRIUMPH Tiger 800 / Tiger 800 XC (11 > 14)	
ES6403K	TRIUMPH Tiger Explorer 1200 (12 > 14)	
ES2105K	YAMAHA XT 660Z Teneré (08 > 14)	

PH CYLINDER-COVER || SPOTLIGHTS PROTECTION



PH5108K BMW R1200GS (13 > 14) **NEW**



LP5112 BMW R1200GS ADVENTURE (14) **NEW**

MOTORCYCLE ACCESSORIES

AIRSTARS & SPOILER

UNIVERSAL SPOILER FOR NAKED MOTORCYCLE



KA200 Small universak spoiler for Naked motorcycles, equipped with fitting kit. Smoked colour - (W x H) 34 cm x 29,5 cm



240AK Universal screen for Naked motorcycles. Smoked colour (W x H) 36,5 cm x 33 cm

A240A Universal fitting kit for 240AK

UNIVERSAL SPOILER FOR NAKED MOTORCYCLE TO BE COMBINED WITH THE SPECIFIC FITTING KITS



245A Universal screen for naked motorcycles, smoked colour (W x H) 29 cm x 33,5



245N Universal screen for naked motorcycles, black colour (W x H) 29 cm x 33,5 cm
The inside is painted in matt colour to prevent the front light



246N902K Universal screen for Naked bikes, Smoked colour (W x H) 33,5 cm x 38 cm
With painted bottom frame Glossy black N902



247A Universal screen for Naked motorcycles, smoked colour (H x W) 28,5 cm x 29 cm



247N Universal screen for naked bikes, black colour (W x H) 29 cm x 28,5 cm
The inside is painted in matt colour to prevent the front light from reflecting

UNIVERSAL CUSTOM SCREENS



KA100B Universal screen with fitting kit

23A+
AS100A2 Universal screen, low and transparent version (H x W) 38,8 cm x 41 cm



KA100N Universal screen with fitting kit

A35N+
AS100A2 Universal wind-screen, high and shaded bottom version (H x W) 54,9 cm x 46,8 cm

UNIVERSAL WINDSCREENS | 2/4 JOINT POINTS



KA610 Universal screen with 2 point handlebar, with fitting kit

33A
+ KD40 Universal screen with 2 points handlebar, transparent (H x W) 46 cm x 57 cm
Fitting kit with 2 point handlebar



KA660 Universal screen with 2 point handlebar, smoked 42,5 x 42 cm (H x W). Fitting kit KD40 included

KD40 **SPARE PARTS:** Fitting kit with 2 point handlebar



KA620 Universal screen with 4 point handlebar, with fitting kit

620A
+ KD45 Universal screen with 4 point handlebar, transparent (H x W) 57 cm x 59 cm
Fitting kit with 4 point handlebar



KA621 Universal screen with 4 point handlebar, with fitting kit

A34
+ KD45 Universal screen with 4 point handlebar, smoked 49 x 50 cm (H x W)
Fitting kit with 4 point handlebar



KAF49 Universal sliding wind-screen, transparent, with 4 point handlebar complete with fitting kit KD45 - Maximum height 53 cm (12 cm of extension) width 52 cm

KD45 **SPARE PARTS:** Fitting kit with 4 point handlebar



Z278 Adaptor kit for installing windscreens with 2 or 4 joint points on motorcycles equipped with nonn tubular handlebars

MOTORCYCLE ACCESSORIES



KAF1110 Honda Crosstourer 1200 (12>14), Specific AIRSTREAM® sliding wind-screen transparent.



KAF7703 KTM 1190 Adventure / 1190 Adventure R (13>14) Specific AIRSTREAM® sliding wind-screen transparent. Maximum height 64 cm (12 cm of excursion) width 41 cm



KAF3105 Suzuki DL1000 V-Strom (14) Specific sliding wind-screen transparent, AIRSTREAM®. Maximum height 50 cm (12 cm of extension) width 44 cm

NAKED WITH SPECIFIC FITTING KIT



KA4109 Kawasaki Z750 S (05 > 07) Specific screen, smoked 28 x 32 cm (H x W)



KA2115 Yamaha MT-09 (13>14) **NEW** Specific screen, smoked 28.5 x 36 cm (H x W)



KA6405 Triumph Street Triple 675 (13>14) **NEW** Specific screen, black 28,5 x 36 cm (H x W)

AIRSTAR FOR SCOOTER



4111DT+ Kawasaki J300 (14)
D4111KIT Specific screen, transparent 79.5 x 65 cm (H x L)



KD3104ST Suzuki 650 Burgman / 650 Burgman Executive (13>14) Specific screen, transparent 76 x 75 cm (H x L)



KD1123ST Honda Forza 300 ABS (13>14) Specific screen, transparent 73 x 59 cm (H x L)



2111DT+ D2111KIT Yamaha X-Max 125-250 (14) / X-Max 400 (13>14)
Specific screen, transparent
73 x 59 cm (H x W)



KD6104ST Kymco Xciting 400i (13>14)
Specific wind-screen
colour transparent (H x W) 85,5 x 66 cm



KD6103ST Kymco K-XCT 125i-300i (13>14)
Specific screen, transparent
83 x 57 cm (H x W)

SPOILER



KD3105ST Suzuki DL1000 V-Strom (14) **NEW**
Specific screen, transparent 50 x 39,5
cm (H x W)



KD7401ST Ducati Multistrada 1200 (13>14)
Specific screen, transparent
56 x 42 cm (H x W)



5107DT+ D5107KIT BMW F700GS (13>14)
BMW F650GS / F800GS (08>14)
Specific screen, transparent
50 x 49 cm (H x W)



5108DT+ D5108KIT BMW R1200GS (13>14) / R1200GS
ADVENTURE (14)
Specific screen, transparent
55 x 44,5 cm (H x W)



KD1119S Honda CBR500R (13>14)
Specific screen, smoked
35 x 30,5 cm (H x W)



KD5110ST BMW F800GS Adventure (13>14)
Specific screen, transparent
48 x 55 cm (H x W)

MOTORCYCLE ACCESSORIES

EXHIBITORS



K5020K



K5019K



OADVNM



K6048K

K6040K



K6041K



K6043EA



K6019



K6049K

K5020K NEW Exhibitor for 3 Monolock top-cases

K5018K NEW Exhibitor for soft luggage

K5019K NEW Exhibitor for 3 Monokey top cases

K5011K Exhibitor for 3 top-cases

K5012K Exhibitor for soft luggage

K5013K Exhibitor for 6 top-cases

K6019 KAPPA Carpet. Dimensions: (H x L) 150 x 200 cm

K6041K Display rack for Airstream windshield, complete with the KAF330 specific for BMW R1200GS (04 > 10)

K6043EA Grey slat wall display shelf for "Tanklock" soft tank bags, can also be used as a counter display.

K6040K Exhibitor 360° display for KAPPA accessories. Dimensions: (H x L) 183 x 55 cm

OADVNM SHOP STICKER (KAPPA LOGO) Dimensions: (HxL) 25x10,8 cm

K6048K Exhibitor for 3 Garda cases Dimensions: (HxL) 130x80 cm

K6049K Grey wall metallic exhibitor. Dimensions: (HxL) 231x192 cm

K6049BM Support for displaying soft luggage on K6049K

K6049SP Support for displaying wind screens and spoilers on K6049K

K6049TL Support for displaying Tanklock soft bags on K6049K

K6049CA Support for displaying helmets on K6049K

K6049TG Back graphic panel

K6049DEP Brochure holder

K6049PKIT Kit with 2 screws TCEI M6X40 for mounting the universal Monokey plates K636 or Monolock plates, on K6049K*

*The Monokey plates must be purchased separately, Monolock plates are included inside the topcases

SPECIFIC EQUIPMENT FOR MOTORCYCLE AND SCOOTER

See the specific equipment for your bike sorted for model and engine size motorcycle

SPECIFIC FITTING KIT FOR HARD BAGS



FITTINGS FOR **TOP CASES**



FITTINGS FOR **SIDE CASES**

HOLDERS FOR SOFT BAGS



FITTINGS FOR **TANK BAGS WITH "TANKLOCK SYSTEM"**



FITTINGS FOR **TANK BAGS WITH TANKY BASIS**



FITTINGS FOR **SADDLE BAGS**



SCREENS

SPECIFIC SCREENS



ENGINE GUARDS AND OIL CARTER PROTECTOR

ENGINE GUARDS OR OIL CARTER PROTECTOR

VARIOUS ACCESSORIES

ACCESSORIES

SPECIFIC BACKRESTS

MUDGUARDS / ABS SPECIFIC CHAIN-COVERS













SPECIFIC SUPPORTS TO WIDEN THE SURFACE SUPPORT AREA
OF THE ORIGINAL SIDE STAND

MOTORCYCLE ACCESSORIES















CODE	DESCRIPTION	PRICE
APRILIA		
APRILIA Scarabeo 50 Street (09 > 13)		
 KR6705	Specific rear rack for MONOLOCK ® top case <i>to be combined with the plate already included in the MONOLOCK® top case</i>	
 152A	↘ Specific screen, transparent 48 x 66 cm (H x W) <i>to be combined with the specific A6704A fitting kit</i>	
153A	Specific screen, transparent 56 x 66 cm (H x W) <i>to be combined with the specific A6704A fitting kit</i>	
A6704A	Specific fitting kit for 152A and 153A	
APRILIA Scarabeo 50-100 (09 > 13)		
 152A	↘ Specific screen, transparent 48 x 66 cm (H x W) <i>to be combined with the specific A6704A fitting kit</i>	
153A	Specific screen, transparent 56 x 66 cm (H x W) <i>to be combined with the specific A6704A fitting kit</i>	
A6704A	Specific fitting kit for 152A and 153A	
APRILIA Sportcity one 50-125 (08 > 13)		
 KR740	Specific rear rack for MONOLOCK ® top case <i>maximum load allowed 3 kg / to be combined with the plate already included in the MONOLOCK® top case</i>	
 134A	Specific screen, transparent 66 x 67 cm (H x W) <i>to be combined with the specific A151A fitting kit / It can be mounted with A151A fitting kit / with hand protectors</i>	
136A	Specific screen, transparent 74 x 67 cm (H x W) <i>In order to install it use the A151A kit / with hand protectors</i>	
A151A	Specific fitting kit for 134A and 136A <i>Black colour</i>	
APRILIA SR 50 Ditech (97 > 05)		
 KR78	Specific rear rack for MONOLOCK ® top case <i>to be combined with the plate already included in the MONOLOCK® top case</i>	
APRILIA Atlantic 125-200-250-300 (03 > 13)		
 KD242ST	Specific screen, transparent 84 x 70 cm (H x W) <i>to be mounted instead of the original screen / 19 cm higher than the original / with hand protectors</i>	
APRILIA Habana 125 (00 > 09)		
 KR74	Specific rear rack for MONOLOCK ® or MONOKEY ® top case <i>to be combined with the K636 MONOKEY® plate, or with the plate already included in the MONOLOCK® top cases</i>	
APRILIA RS 125		
 BF02K	Specific flange for fitting the tank bags with Tanklock system	
APRILIA Scarabeo 125-200 (07 > 06/2011)		
 KE3180	↘ Specific rear rack for MONOLOCK ® top case <i>to be combined with the plate already included in the MONOLOCK® top case</i>	
 154A	Specific screen, transparent 53 x 70 cm (H x W) <i>to be combined with the specific A154A fitting kit</i>	
A154A	Specific fitting kit for 154A	
APRILIA Scarabeo 125-200 (from July 11 > 14)		
 KR6701	Specific rear rack for MONOLOCK ® top case <i>maximum load allowed 3 kg / to be combined with the plate already included in the MONOLOCK® top case</i>	
 1000A	Specific screen, transparent 53 x 70 cm (H x W) <i>to be combined with the specific A154A fitting kit</i>	
A154A	Specific fitting kit for 1000A	



↘ = Item available until it runs out of stock

CODE	DESCRIPTION	PRICE
APRILIA Sportcity 125-200-250 (04 > 08)		
 KE3160	Specific rear rack for MONOLOCK ® top case to be combined with the plate already included in the MONOLOCK ® top case	
 105A	Specific screen, transparent 66 x 67 cm (H x W) to be combined with the specific A129A fitting kit	
128A	Specific screen, transparent 74 x 67 cm (H x W) to be combined with the specific A129A fitting kit/ 8 cm higher than 105A	
A129A	Specific fitting kit for 128A and 105A	
APRILIA Sportcity Cube 125-200-300 (08 > 13)		
 KE3190	Specific rear rack for MONOLOCK ® top case	
 134A	Specific screen, transparent 66 x 67 cm (H x W) to be combined with the specific A150A fitting kit/ In order to install it use the specific fitting kit A151A / With hand protectors	
136A	Specific screen, transparent 74 x 67 cm (H x W) to be combined with the specific A150A fitting kit/ In order to fit it you must use the specific fitting kit A150A / With hand protectors	
A150A	Specific fitting kit for 134A and 136A	
APRILIA Scarabeo 250-300 (07 > 14)		
 K317M	Specific rear rack for MONOLOCK ® top case MONOLOCK ® plate included / in order to install it you must drill the frame behind the saddle / it is necessary to puncture the housing behind the saddle in arranged sections/ max load allowed: 3 kg	
KE7300	Specific rear rack for MONOLOCK ® top case it is necessary to puncture the housing behind the saddle in arranged sections	
 130A	Specific screen, transparent 50 x 72 cm (H x W) to be combined with the specific A148A fitting kit/ With hand protectors / In order to install it use the original fitting kit of the scooter and the item A130A	
A148A	Specific fitting kit for 130A	
APRILIA Atlantic 400-500 Sprint (05 > 12)		
 KD242ST	Specific screen, transparent 84 x 70 cm (H x W) to be mounted instead of the original screen / 19 cm higher than the original / with hand protectors	
APRILIA Scarabeo 400-500 (06 > 12)		
 K317M	Specific rear rack for MONOLOCK ® top case MONOLOCK ® plate included / in order to install it you must drill the frame behind the saddle / it is necessary to puncture the housing behind the saddle in arranged sections/ max load allowed: 3 kg	
KE7300	Specific rear rack for MONOLOCK ® top case it is necessary to puncture the housing behind the saddle in arranged sections	
 130A	Specific screen, transparent 50 x 72 cm (H x W) to be combined with the specific A130A fitting kit/ In order to install it use the original fitting kit of the scooter and A130A / with hand protectors	
A130A	Specific fitting kit for 130A	
APRILIA Atlantic 500 (02 > 06)		
 KD240ST	Specific screen, transparent 65 x 69 cm (H x W) to be mounted instead of the original screen / 9 cm higher than the original	
APRILIA Scarabeo 500 (03 > 05)		
 KD243ST	Specific screen, transparent 66 x 50 cm (H x W) to be mounted instead of the original screen / 18 cm higher than the original	
APRILIA Pegaso 650 Strada / Trail (05 > 11)		
 KR79	Specific rear rack for MONOKEY ® top case MONOKEY ® plate included / maximum load allowed 6 Kg	
APRILIA Shiver 750 / Shiver GT 750 (07 > 09)		
 BF02K	Specific flange for fitting the tank bags with Tanklock system	
VARIOUS ACCESSORIES 01SKIT	Specific kit to mounting the KS900A Smart Bar	

MOTORCYCLE ACCESSORIES









CODE	DESCRIPTION	PRICE
APRILIA Shiver 750 (10 > 14)		
 KZ6702	Specific rear rack for MONOKEY ® or MONOLOCK ® top case to be combined with the MONOKEY ® KM5 or KM7 plates, or with the MONOLOCK ® KM5M or KM6M plates / a handle bar for the passenger is included, you must remove the original grab rails	
 TE6702K	Specific holder for soft side bags	
 BF02K	Specific flange for fitting the tank bags with Tanklock system	
VARIOUS ACCESSORIES 01SKIT	Specific kit to mounting the KS900A Smart Bar	
APRILIA Dorsoduro 750 (08 > 14)		
 KR6700M	Specific rear rack for MONOLOCK ® top case MONOLOCK ® plate included / you must puncture the housing in arranged sections	
 TE6700K	Specific holder for soft side bags	
VARIOUS ACCESSORIES 01SKIT	Specific kit to mounting the KS900A Smart Bar	
APRILIA Mana 850 / Mana 850 GT (08 > 14)		
 KZ732	Specific rear rack for MONOKEY ® or MONOLOCK ® top case to be combined with the MONOKEY ® KM5 or KM7 plates, or with the MONOLOCK ® KM5M or KM6M plates / in order to install it you must remove the grab handles / it is compatible with the original side-case holders	
VARIOUS ACCESSORIES 01SKIT	Specific kit to mounting the KS900A Smart Bar	
APRILIA SRV 850 (12 > 13) NEW		
 KR6703	↘ Specific rear rack for MONOKEY ® top case MONOKEY ® plate included / it is necessary to puncture the housing behind the saddle in arranged sections	
KR6703M	↘ Specific rear rack for MONOLOCK ® top case MONOLOCK ® plate included	
 TE6703K	↘ Specific holder for soft side bags	
 KD6703ST	Specific screen, transparent. 78 x 62 cm (H x W) to be mounted instead of the original screen	
APRILIA ETV 1000 Caponord (01 > 10)		
 KL313	Specific pannier holder for MONOKEY ® side cases	
 BF02K	Specific flange for fitting the tank bags with Tanklock system	
 KD239ST	↘ Specific screen, transparent 64 x 65,5 cm (H x W) to be mounted instead of the original screen / compatible with year 2003	
APRILIA Caponord 1200 (13 > 14) NEW		
 KRA6706	Specific rear rack in aluminium for MONOKEY ® top case maximum load allowed 6kg / it does not allow the assembly of the stop light kit or the remote control device on the case	
 KL6706	Specific pannier holder for MONOKEY ® side cases	
 KD6706ST	Specific screen, transparent 58 x 45 cm (H x W) to be mounted instead of the original screen / 10 cm higher than the original	
VARIOUS ACCESSORIES ES6706K	Specific support in aluminum and stainless steel to widen the surface support area of the original side stand	
01SKIT	Specific kit to mounting the KS900A Smart Bar	

BENELLI







BENELLI BN600 (13 > 14) NEW		
 KR8701	Specific rear rack for MONOKEY ® top case maximum load allowed 6 kg / MONOKEY ® plate included	
KR8701M	Specific rear rack for MONOLOCK ® top case to be combined with the plate already included in the MONOLOCK ® top case	















↘ = Item available until it runs out of stock

CODE	DESCRIPTION	PRICE
 KL8701	Specific pannier holder for MONOKEY ® side cases	
 BF02K	Specific flange for fitting the tank bags with Tanklock system	
VARIOUS ACCESSORIES 03SKIT	Specific kit to mounting the KS900A Smart Bar	
BENELLI Café Racer 899 (10)		
 BF02K	Specific flange for fitting the tank bags with Tanklock system	
BENELLI TRE 899 K / TRE 11130 K (06 > 14)		
 BF02K	Specific flange for fitting the tank bags with Tanklock system	
BENELLI TORNADO NAKED TRE 899 (10)		
 BF02K	Specific flange for fitting the tank bags with Tanklock system	
BENELLI TORNADO NAKED TRE 899S (10)		
 BF02K	Specific flange for fitting the tank bags with Tanklock system	
BENELLI Café Racer 1130 (10)		
 BF02K	Specific flange for fitting the tank bags with Tanklock system	
BENELLI Titanium (10)		
 BF02K	Specific flange for fitting the tank bags with Tanklock system	
BENELLI TORNADO NAKED TRE R160 (10)		
 BF02K	Specific flange for fitting the tank bags with Tanklock system	

BMW

BMW C 600 Sport (12 > 14)		
 KR5105	Specific rear rack for MONOKEY ® top case MONOKEY ® plate included	
KRA5105	Specific rear rack in aluminium for MONOKEY ® top case maximum load allowed 6kg / it does not allow the assembly of the stop light kit or the remote control device on the case	
KR5105M	Specific rear rack for MONOLOCK ® top case MONOLOCK ® plate included	
 TE5105K	Specific holder for soft side bags	
 KD5105ST	Transparent screen composed of three pieces - main screen-blade and two hand protectors. 73,5 x 73 cm (H x W) to be mounted instead of the original screen / 12 cm higher than original	
DF5105K	Pair of fixed quarter vents complete with the specific fitting kit. specific fitting kit included / compatible with the original screen	
BMW C 650 GT (12 > 14)		
 KRA5106	Specific rear rack in aluminium for MONOKEY ® top case maximum load allowed 6kg / it does not allow the assembly of the stop light kit or the remote control device on the case	
 KL5106	Specific pannier holder for MONOKEY ® side cases it can be mounted only with the specific rear rack KRA5106 / maximum load allowed 6 Kg for pannier	
 KD5106ST	Transparent screen composed of three pieces - main screen-blade and two hand protectors. 81 x 58 cm (H x W) to be mounted instead of the original screen / 13 cm higher than original	
DF5106K	Pair of fixed quarter vents complete with the specific fitting kit/ compatible with the original screen specific fitting kit included / compatible with the original screen	

MOTORCYCLE ACCESSORIES





CODE	DESCRIPTION	PRICE
BMW F 650 (94 > 96)		
 KD230S	Specific screen, smoked 45,7 x 42,3 cm (H x W)	
BMW F 650 CS Scarver (02 > 06)		
 KR682M	Specific rear rack for MONOLOCK ® top case MONOLOCK ® plate included / maximum load allowed 8 Kg	
BMW F 650 GS (00 > 03)		
 K6390	Specific rear rack for MONOKEY ® or MONOLOCK ® top case <i>To be combined with the plate MONOKEY® K553N, or with the plate MONOLOCK® MKN / it cannot be mounted with the original side-case holder / compatible from august '00</i>	
 KL188	Specific pannier holder for MONOKEY ® side cases	
 KD234S	Specific screen, smoked 41,1 x 34 cm (H x W) <i>to be mounted instead of the original screen</i>	
BMW F 650 GS (04 > 07)		
 KR685	Specific rear rack for MONOKEY ® top case	
 KL188	Specific pannier holder for MONOKEY ® side cases	
 KD331ST	Specific screen, transparent 39,5 x 44 cm (H x W) <i>to be mounted instead of the original screen / 15,5 cm higher than original / not mounted with original guards</i>	
BMW F 650 GS / F 800 GS (08 > 14)		
 KRA5103	Specific rear rack in aluminium for MONOKEY ® top case <i>can not be mounted with art. KL690 / maximum load allowed 6kg / it does not allow the assembly of the stop light kit or the remote control device on the case</i>	
KR5107	Specific rear rack for MONOKEY ® top case <i>can not be mounted with art. KL690 / MONOKEY® plate included</i>	
K94	Specific rear rack for MONOKEY ® top case MONOKEY ® plate included / <i>Is compatible with the rear plate / only for F 650 GS / F 800 GS (08-11)</i>	
K94M	Specific rear rack for MONOLOCK ® top case MONOLOCK ® plate included / <i>only for F 650 GS / F 800 GS (08-11)</i>	
 KL690	Specific pannier holder for MONOKEY ® side cases <i>it can be mounted only with the specific plate K94 or K94M / only for F 650 GS / F 800 GS (08>11)</i>	
KLR5103	Specific rapid release side case holder for MONOKEY ® cases <i>from 2012</i>	
 BF15K	Specific flange for fitting the tank bags with Tanklock system	
 333DT	Specific screen, transparent 44 x 46 cm (H x W) <i>to be combined with the specific D333KIT fitting kit / 26 cm higher than the original F650GS / 22 cm higher than the model F800GS</i>	
D333KIT	Specific fitting kit for 333DT	
5107DT	Specific screen, transparent 50 x 49 cm (H x W) <i>to be combined with the specific D5107KIT fitting kit / only for version F700GS (13)</i>	
D5107KIT	Specific fitting kit for 5107DT	
KAF5107	Specific Airstream sliding wind-screen transparent. Maximum height 53 cm (12 cm of excursion), width 51 cm <i>only for F 700 GS (13) / complete with specific fitting kit / to be mounted instead of the original screen</i>	
 KN690	Specific engine guard <i>we recommend fitting by a qualified mechanic</i>	
KN5103	Specific engine guard <i>only for F800GS (13) / we recommend fitting by a qualified mechanic / black colour</i>	
RP5103	Oil carter protector in Aluminium	
VARIOUS ACCESSORIES		
KHP5103	Hand protector specific ABS <i>only for F800GS (13 > 14) /</i>	
KMG5103	Mudguard/specific ABS chain-cover, black colour	
ES5107K	Specific support in aluminum and stainless steel to widen the surface support area of the original side stand <i>only for F800GS (13) / only for BMW F650GS (13) / F700GS (13 > 14)</i>	
ES5110K	Specific support in aluminum and stainless steel to widen the surface support area of the original side stand <i>only for F800GS (13) / only for BMW F800 GS Adventure (13 > 14)</i>	



↘ = Item available until it runs out of stock



















CODE	DESCRIPTION	PRICE
BMW F 650 GS Dakar (00 > 03)		
K6390	Specific rear rack for MONOKEY ® or MONOLOCK ® top case <i>To be combined with the plate MONOKEY® K553N, or with the plate MONOLOCK® MKN / it cannot be mounted with the original side-case holder / compatible from august '00</i>	
KL188	Specific pannier holder for MONOKEY ® side cases	
BMW F 650 ST (97 > 99)		
KL185	Specific pannier holder for MONOKEY ® side cases	
BMW G 650 GS (11 > 14)		
KR685	Specific rear rack for MONOKEY ® top case	
KL188	Specific pannier holder for MONOKEY ® side cases	
BF19K	Specific flange for fitting the tank bags with Tanklock system	
KD5101ST	Specific screen, transparent 41 x 39 cm (H x W) <i>to be mounted instead of the original screen / 22 cm higher than the original</i>	
KN5101	Specific engine guard <i>we recommend fitting by a qualified mechanic</i>	
VARIOUS ACCESSORIES ES5101K	Specific support in aluminum and stainless steel to widen the surface support area of the original side stand	
01SKIT	Specific kit to mounting the KS900A Smart Bar	
BMW F 700 GS (13 > 14)		
KRA5103	Specific rear rack in aluminium for MONOKEY ® top case <i>maximum load allowed 6kg / it does not allow the assembly of the stop light kit or the remote control device on the case</i>	
KR5107	Specific rear rack for MONOKEY ® top case MONOKEY ® plate included	
KLR5103	Specific rapid release side case holder for MONOKEY ® cases <i>from 2012</i>	
BF15K	Specific flange for fitting the tank bags with Tanklock system	
333DT	Specific screen, transparent 44 x 46 cm (H x W) <i>to be combined with the specific D333KIT fitting kit / 26 cm higher than the original F650GS / 22 cm higher than the model F800GS</i>	
D333KIT	Specific fitting kit for 333DT	
5107DT	Specific screen, transparent 50 x 49 cm (H x W) <i>to be combined with the specific D5107KIT fitting kit / only for version F700GS (13)</i>	
D5107KIT	Specific fitting kit for 5107DT	
KAF5107	Specific Airstream sliding wind-screen transparent. Maximum height 53 cm (12 cm of excursion), width 51 cm <i>only for F 700 GS (13) / complete with specific fitting kit / to be mounted instead of the original screen</i>	
KN5103	Specific engine guard <i>we recommend fitting by a qualified mechanic / black colour</i>	
KN690	Specific engine guard <i>we recommend fitting by a qualified mechanic</i>	
RP5103	Oil carter protector in Aluminium	
VARIOUS ACCESSORIES KMG5103	Mudguard/specific ABS chain-cover, black colour	
01SKIT	Specific kit to mounting the KS900A Smart Bar	
ES5107K	Specific support in aluminum and stainless steel to widen the surface support area of the original side stand <i>only for BMW F650GS (13) / F700GS (13 > 14)</i>	
BMW K75 750		
K108	Specific rear rack for MONOKEY ® top case MONOKEY ® plate included / <i>it is necessary to puncture the housing behind the saddle</i>	
BMW F 800 ST (06 > 14)		
KLX687	Specific pannier holder for K33 MONOKEY ® SIDE cases	

MOTORCYCLE ACCESSORIES

















CODE	DESCRIPTION	PRICE
BMW F 800 S (06 > 14)		
 KZ687	Specific rear rack for MONOKEY ® or MONOLOCK ® top case to be combined with the MONOKEY ® KM5 or KM7 plates, or with the MONOLOCK ® KM5M or KM6M plates	
 KLX687	Specific pannier holder for K33 MONOKEY ® SIDE cases	
BMW F 800 GS Adventure (13 > 14)		
 KRA5103	Specific rear rack in aluminium for MONOKEY ® top case maximum load allowed 6kg / it does not allow the assembly of the stop light kit or the remote control device on the case	
KR5107	Specific rear rack for MONOKEY ® top case MONOKEY ® plate included	
 KD5110ST	Specific screen, transparent 48 x 55 cm (H x W) to be mounted instead of the original screen / 17 cm higher than the original	
KAF5110	Specific sliding wind-screen transparent, AIRSTREAM for BMW F800GS Adventure (13 > 14) to be mounted instead of the original screen	
EH5108K	Plexiglass extension for original hand protectors, smoked	
 RP5103	Oil carter protector in Aluminium	
KNH51100X	Specific engine guard, stainless steel we recommend fitting by a qualified mechanic / mount with original engine guard / It protects the upper part of the radiators	
VARIOUS ACCESSORIES ES5110K	Specific support in aluminum and stainless steel to widen the surface support area of the original side stand only for BMW F800 GS Adventure (13 > 14)	
01SKIT	Specific kit to mounting the KS900A Smart Bar	
BMW F 800 GT (13 > 14)		
 KR5109	Specific rear rack for MONOKEY ® top case MONOKEY ® plate included	
 KLR5109	Specific rapid release side case holder for MONOKEY ® cases	
 BF16K	Specific flange for fitting the tank bags with Tanklock system	
 KD5109ST	Specific screen, transparent 62 x 58 cm (H x W) to be mounted instead of the original screen / 17.5 cm higher than original	
KD5109S	Specific screen, smoked 58 x 40 cm (H x W) to be mounted instead of the original screen / 13.5 cm higher than original	
VARIOUS ACCESSORIES 01SKIT	Specific kit to mounting the KS900A Smart Bar	
BMW F 800 R (09 > 14)		
 KRA691	Specific rear rack in aluminium for MONOKEY ® top case can not be mounted with the original side-case / maximum load allowed 6kg / it does not allow the assembly of the stop light kit or the remote control device on the case	
 KLR693	Specific rapid release side case holder for MONOKEY ® cases is not compatible with the original carrier	
 TE5111K	Specific holder for soft side bags	
 BF16K	Specific flange for fitting the tank bags with Tanklock system	
 KN691	Specific engine guard we recommend fitting by a qualified mechanic / black colour	
VARIOUS ACCESSORIES 01SKIT	Specific kit to mounting the KS900A Smart Bar	
BMW R 850 GS (94 > 01)		
 KL189	Specific pannier holder for MONOKEY ® side cases	
BMW R 850 R (95 > 02)		
 K6350	Specific rear rack for MONOKEY ® or MONOLOCK ® top case To be combined with the plate MONOKEY ® K553N, or with the plate MONOLOCK ® MKN / it is compatible with the original side-case holder	
BMW R 850 R (03 > 07)		
 KR683	Specific rear rack for MONOKEY ® top case is not compatible with the R850R Comfort MONOKEY ® plate included / to be mounted only with the original side-case holder / maximum load allowed 6 Kg / it is not compatible with R850R Comfort	



↘ = Item available until it runs out of stock

CODE	DESCRIPTION	PRICE
BMW K 100 (90)		
 K108	Specific rear rack for MONOKEY ® top case MONOKEY ® plate included / it is necessary to puncture the housing behind the saddle	
BMW S 1000 RR (12 > 14)		
 KD5104S	Specific screen, smoked 45 x 36 cm (H x W) to be mounted instead of the original screen	
 BF06K	Specific flange for fitting the tank bags with Tanklock system	
BMW K 1100 RS		
 K108	Specific rear rack for MONOKEY ® top case MONOKEY ® plate included / it is necessary to puncture the housing behind the saddle	
BMW R 1100 GS (94 > 99)		
 KR694	Specific rear rack for MONOKEY ® top case MONOKEY ® plate included	
 KL189	Specific pannier holder for MONOKEY ® side cases	
BMW R 1100 R (95 > 01)		
 K6350	Specific rear rack for MONOKEY ® or MONOLOCK ® top case To be combined with the plate MONOKEY ® K553N, or with the plate MONOLOCK ® MKN/ it is compatible with the original side-case holder	
BMW R 1100 RS (94 > 98)		
 K83	Specific rear rack for MONOKEY ® top case to fit to the original rack	
BMW R 1100 RT (96 > 00)		
 K83	Specific rear rack for MONOKEY ® top case to fit to the original rack	
BMW R 1150 GS (00 > 03)		
 KR694	Specific rear rack for MONOKEY ® top case MONOKEY ® plate included	
 KL189	Specific pannier holder for MONOKEY ® side cases	
 KD233S	Specific screen, smoked 48,5 x 36,6 cm (H x W)	
BMW R 1150 R (01 > 06)		
 KR683	Specific rear rack for MONOKEY ® top case MONOKEY ® plate included / to be mounted only with the original side-case holder / maximum load allowed 6 Kg / it is not compatible with R850R Comfort	
 BF11K	Specific flange for fitting the tank bags with Tanklock system	
BMW R 1150 RT (01)		
 K83	Specific rear rack for MONOKEY ® top case to fit to the original rack	
BMW R 1150 RT (02 > 04)		
 K91	Specific rear rack for MONOKEY ® top case to fit to the original rack / MONOKEY ® plate included	
 KD241ST	Specific screen, transparent 48 x 51 cm (H x W)	
BMW K 1200 GT (03 > 04)		
 K6800	Specific rear rack for MONOKEY ® or MONOLOCK ® top case To be combined with the plate MONOKEY ® K553N, or with the plate MONOLOCK ® MKN/ it is compatible with the original side-case holder	

MOTORCYCLE ACCESSORIES

CODE	DESCRIPTION	PRICE
BMW	K 1200 R (05 > 08) / K 1300 R (09 > 14) NEW	
 KRA690	Specific rear rack in aluminium for MONOKEY ® top case <i>it can be fitted with the original side-case / maximum load allowed 6kg / it does not allow the assembly of the stop light kit or the remote control device on the case</i>	
 KLXR691	Specific rapid release side case holder for K33 MONOKEY ® SIDE cases <i>you must move the indicators from their original position</i>	
BMW	K 1200 S (05 > 08) / K 1300 S (09 > 14)	
 KLR692	Specific rapid release side case holder for MONOKEY ® cases	
 KD334S	↘ Specific screen, smoked 42,2 x 42,5 cm (H x W)	
BMW	K 1200 GT / K 1300 GT (06 > 11)	
 KRA693	Specific rear rack in aluminium for MONOKEY ® top case <i>it can be fitted with the original side-case / maximum load allowed 6kg / it does not allow the assembly of the stop light kit or the remote control device on the case</i>	
BMW	K 1200 RS (00 > 04)	
 K6800	Specific rear rack for MONOKEY ® or MONOLOCK ® top case <i>To be combined with the plate MONOKEY® K553N, or with the plate MONOLOCK® MKN/ it is compatible with the original side-case holder</i>	
 BF11K	Specific flange for fitting the tank bags with Tanklock system	
BMW	R 1200 GS (04 > 12)	
 KR684	Specific rear rack for MONOKEY ® top case <i>to fit to the original rack / maximum load allowed 6 Kg / MONOKEY® plate included / year '04 - '11 / it is compatible with the original sidecase</i>	
KR689	Specific rear rack for MONOKEY ® top case <i>MONOKEY® plate included / in replacement of original rack / is compatible with the original side case holder</i>	
KRA692	Specific rear rack in aluminium for MONOKEY ® top case <i>it can be fitted with the original side-case / maximum load allowed 6kg / it does not allow the assembly of the stop light kit or the remote control device on the case / compatible from '07 to '12</i>	
 KL684	Specific pannier holder for MONOKEY ® side cases	
KLR684	Specific rapid release side case holder for MONOKEY ® cases	
 BF13K	Specific flange for fitting the tank bags with Tanklock system <i>only for BMW R1200 GS (09 > 12)</i>	
BF07K	Specific flange for fitting the tank bags with Tanklock system <i>only for BMW R1200 GS (08)</i>	
 330DT	Specific screen, transparent 51,5 x 56,5 cm (H x W) <i>to be combined with the specific D330KIT fitting kit/ 14,5 cm higher than the original / adjustable as the original / only for version F650GS/F850GS</i>	
D330KIT	Specific fitting kit for 330DT <i>only for version F650GS/F850GS</i>	
KAF330	Specific Airstream sliding wind-screen transparent. Maximum height 54 cm (12 cm of extension) width 54 cm <i>complete with specific fitting kit / to be mounted instead of the original screen</i>	
 KN689	Specific engine guard <i>we recommend fitting by a qualified mechanic</i>	
VARIOUS ACCESSORIES	ES684K	Specific support in aluminum and stainless steel to widen the surface support area of the original side stand <i>only for BMW R1200 GS (04 > 05)</i>
ES5102K	Specific support in aluminum and stainless steel to widen the surface support area of the original side stand <i>only for BMW R1200 GS (07 > 12) / R1200 GS Adventure (14)</i>	
BMW	R 1200 GS (13 > 14)	
 KR5108	Specific rear rack for MONOKEY ® top case <i>MONOKEY® plate included</i>	
KRA5108	Specific rear rack in aluminium for MONOKEY ® top case <i>maximum load allowed 6kg / it does not allow the assembly of the stop light kit or the remote control device on the case</i>	
 KLR5108	Specific rapid release side case holder for MONOKEY ® cases <i>you must move the indicators from their original position</i>	
 BF11K	Specific flange for fitting the tank bags with Tanklock system	
 5108D	Specific screen smoked 43,5 x 43 cm (H x W) <i>to be combined with the specific D5108DKIT fitting kit / 5 cm higher than the original R1200G and size equal to that of the bike R1200GS Adventure</i>	
5108DT	Specific screen, transparent 55 x 44,5 cm (H x W) <i>17 cm higher than original / to be combined with the specific D5108KIT fitting kit</i>	
D5108KIT	Strengthening kit for the 5108DT screen	



↘ = Item available until it runs out of stock

CODE	DESCRIPTION	PRICE
KD5108B	Specific low and sports screen smoked 35.5 x 44 cm (H x W) <i>to be mounted instead of the original screen</i>	
EH5108K	Plexiglass extension for original hand protectors, smoked	
 KN51080X	Specific engine guard, stainless steel <i>we recommend fitting by a qualified mechanic / stainless steel</i>	
KN5108	Specific engine guard <i>we recommend fitting by a qualified mechanic / black colour</i>	
KNH5108	Specific engine guard <i>we recommend fitting by a qualified mechanic / black colour / It protects the upper part of the radiators / compatible with KN51080X/KN5108 / compatible with the original engine guard optional BMW</i>	
KNH51080X	Specific engine guard, stainless steel <i>we recommend fitting by a qualified mechanic / stainless steel / It protects the upper part of the radiators / compatible with KN51080X/KN5108 / compatible with the original engine guard optional BMW</i>	
KNH5114	Specific engine guard <i>we recommend fitting by a qualified mechanic / black colour / It protects the upper part of the radiators / compatible with KN51080X - KN5108 / compatible with the original engine guard optional BMW</i>	
KNH51140X	Specific engine guard, stainless steel <i>we recommend fitting by a qualified mechanic / stainless steel / It protects the upper part of the radiators / compatible with KN51080X - KN5108 / compatible with the original engine guard optional BMW</i>	
RP5108	Oil carter protector in Aluminium	

VARIOUS ACCESSORIES

ES5108K Specific support in aluminum and stainless steel to widen the surface support area of the original side stand

PH5108K Para-cylinder specific anodized aluminum

01SKIT Specific kit to mounting the KS900A Smart Bar

KPR5108 Specific radiator guard

BMW R 1200 GS Adventure (06 > 13)



KRA5102 Specific rear rack in aluminium for **MONOKEY**® top case
it can be fitted with the original side-case / maximum load allowed 6kg / it does not allow the assembly of the stop light kit or the remote control device on the case



KL685 Specific pannier holder for **MONOKEY**® side cases



BF13K Specific flange for fitting the tank bags with Tanklock system
only for BMW R1200 GS Adventure (09 > 13)

VARIOUS ACCESSORIES

ES5102K Specific support in aluminum and stainless steel to widen the surface support area of the original side stand
only for BMW R1200 GS Adventure (07 > 13)

01SKIT Specific kit to mounting the KS900A Smart Bar

BMW R 1200 GS Adventure (14) NEW



KRA5112 Specific rear rack in aluminium for **MONOKEY**® top case
maximum load allowed 6kg / it does not allow the assembly of the stop light kit or the remote control device on the case



KLR5108 Specific rapid release side case holder for **MONOKEY**® cases
you must move the indicators from their original position



BF17K Specific flange for fitting the tank bags with Tanklock system



5108DT Specific screen, transparent 55 x 44.5 cm (H x W)
17 cm higher than original / to be combined with the specific D5108KIT fitting kit

5108D Specific screen smoked
43.5 x 43 cm (H x W)
to be combined with the specific D5108DKIT fitting kit / 5 cm higher than the original R1200G and size equal to that of the bike R1200GS Adventure

D5108KIT Strengthening kit for the 5108DT screen

EH5108K Plexiglass extension for original hand protectors, smoked

VARIOUS ACCESSORIES

ES5112K Specific support in aluminum and stainless steel to widen the surface support area of the original side stand



KNH51120X Specific engine guard, stainless steel
we recommend fitting by a qualified mechanic / mount only in conjunction with the BMW engine guard









RP5112 Oil carter protector in Aluminium

VARIOUS ACCESSORIES

LP5112 Protezione specifica in acciaio e alluminio anodizzato per faretti originali
si monta solo in presenza dei faretti originali optional

KPR5108 Specific radiator guard

MOTORCYCLE ACCESSORIES

CODE	DESCRIPTION	PRICE
BMW R 1200 R (06 > 10)		
 KZ688	Specific rear rack for MONOKEY ® or MONOLOCK ® top case to be combined with the MONOKEY ® KM5 or KM7 plates, or with the MONOLOCK ® KM5M or KM6M plates / it is not compatible with the original side-case holders / fitting kit included	
 PLX688KIT	Specific kit to install the KLX without the rack for the top case	
 147A	Specific screen, transparent 49,5 x 46 cm (H x W) to be combined with the specific A147A fitting kit	
A147A	Specific fitting kit for 147A	
BMW R 1200 R (11 > 14)		
 KR5100	Specific rear rack for MONOKEY ® top case maximum load allowed 6 kg / MONOKEY ® plate included	
KR5100M	Specific rear rack for MONOLOCK ® top case MONOLOCK ® plate included	
 KLXR5100	Specific rapid release side case holder for K33 MONOKEY ® SIDE cases	
 BF06K	Specific flange for fitting the tank bags with Tanklock system	
 147A	Specific screen, transparent 49,5 x 46 cm (H x W) to be combined with the specific A5100A fitting kit	
A5100A	Specific fitting kit for 147A	
 KN5100	Specific engine guard we recommend fitting by a qualified mechanic / black colour	
VARIOUS ACCESSORIES 04SKIT	Specific kit to mounting the KS900A Smart Bar	
BMW R 1200 RT (05 > 13)		
 K93	Specific rear rack for MONOKEY ® top case MONOKEY ® plate included	
BMW R 1200 RT (14) NEW		
 KRA5113	Specific rear rack in aluminium for MONOKEY ® top case maximum load allowed 6kg / it does not allow the assembly of the stop light kit or the remote control device on the case	
VARIOUS ACCESSORIES ES5113K	Specific support in aluminum and stainless steel to widen the surface support area of the original side stand	
BMW R NINE T 1200 (14) NEW		
 TE5115K	Specific holder for soft side bags	

CAGIVA















CAGIVA Mito 125		
 BF05K	Specific flange for fitting the tank bags with Tanklock system	

CAN AM

















CAN AM Spyder 990 (08 > 13)		
 KD770ST	Specific screen, transparent 52 x 46 cm (H x W) 25 cm higher than original	



↘ = Item available until it runs out of stock

CODE	DESCRIPTION	PRICE
DUCATI		
DUCATI Multistrada 620 / Multistrada 1000 DS (03 > 05)		
 KR310	Specific rear rack for MONOKEY ® top case MONOKEY ® plate included / maximum load allowed 10 Kg	
DUCATI Multistrada 620 / Multistrada 1100 (06 > 09)		
 KR311	Specific rear rack for MONOKEY ® top case MONOKEY ® plate included / maximum load allowed 10 Kg	
DUCATI Monster 696 / 796 / 1100 (08 > 12)		
 KZ780	Specific rear rack for MONOKEY ® or MONOLOCK ® top case to be combined with the MONOKEY ® KM5 or KM7 plates, or with the MONOLOCK ® KM5M or KM6M plates / maximum load allowed 6 kg	
 TK681	Specific holder for soft side bags	
7400KIT	Specific kit to install the TE7400K and the TK681 without the specific rear rack	
 TKB06	Specific "Tanky" base for DUCATI MONSTER 696/796/1100 (08>10), compatible with the tank bags TKB748 and TKB751	
 BF09K	Specific flange for fitting the tank bags with Tanklock system	
VARIOUS ACCESSORIES 05SKIT	Specific kit to mounting the KS900A Smart Bar	
DUCATI Hyperstrada 821 (13 > 14) NEW		
 KRA7403	Specific rear rack in aluminium for MONOKEY ® top case maximum load allowed 6kg / it does not allow the assembly of the stop light kit or the remote control device on the case	
VARIOUS ACCESSORIES 03SKIT	Specific kit to mounting the KS900A Smart Bar	
DUCATI Monster S2R / S4R / S4RS 800 - 1000 (04 > 08)		
 TK680	Specific holder for soft side bags	
 BF08K	Specific flange for fitting the tank bags with Tanklock system	
DUCATI ST 2 / ST 4 900 (97 > 01)		
 K6750	Specific rear rack for MONOKEY ® or MONOLOCK ® top case To be combined with the plate MONOKEY ® K553N, or with the plate MONOLOCK ® MKN/ it cannot be mounted with the original side-case holder	
 BF08K	Specific flange for fitting the tank bags with Tanklock system	
DUCATI ST 3 1000 (04 > 08)		
 K6750	Specific rear rack for MONOKEY ® or MONOLOCK ® top case To be combined with the plate MONOKEY ® K553N, or with the plate MONOLOCK ® MKN/ it cannot be mounted with the original side-case holder	
DUCATI 848 - 1098 - 1198 (07 > 12)		
 BF08K	Specific flange for fitting the tank bags with Tanklock system	
DUCATI Streetfighter 848-1098 (09 > 14)		
 TK682	Specific holder for soft side bags	
 247N	Specific screen, black 29 x 28,5 cm (H x W) to be combined with the specific A781A fitting kit	
A781A *	Specific fitting kit for 247N	
VARIOUS ACCESSORIES 04SKIT	Specific kit to mounting the KS900A Smart Bar	

MOTORCYCLE ACCESSORIES

CODE	DESCRIPTION	PRICE
DUCATI Monster 1100 Evo (11-12)		
 KZ780	Specific rear rack for MONOKEY ® or MONOLOCK ® top case to be combined with the MONOKEY ® KM5 or KM7 plates, or with the MONOLOCK ® KMSM or KM6M plates / maximum load allowed 6 kg	
 TE7400K	Specific holder for soft side bags <i>it can be mounted without the specific rear rack KZ780 using the 7400KIT / you must move the indicators from their original position</i>	
7400KIT	Specific kit to install the TE7400K and the TK681 without the specific rear rack	
 BF09K	Specific flange for fitting the tank bags with Tanklock system	
DUCATI 1199 Panigale (12-13)		
 KD7402S	Specific screen, smoked 35 x 27 cm (H x W) <i>to be mounted instead of the original screen</i>	
DUCATI Monster 1200 (14) NEW		
 BF08K	Specific flange for fitting the tank bags with Tanklock system	
 TE7404K	Specific holder for soft side bags	
 KA7404	Specific screen, smoked 28,5 x 36 cm (H x W) <i>Complete with fitting kit</i>	
VARIOUS ACCESSORIES 05SKIT	Specific kit to mounting the KS900A Smart Bar	
DUCATI Hypermotard 1100 (>12)		
VARIOUS ACCESSORIES 03SKIT	Specific kit to mounting the KS900A Smart Bar	
DUCATI Multistrada 1200 (10 > 13)		
 KR312	Specific rear rack for MONOKEY ® top case MONOKEY ® plate included / is compatible with the original side case holder	
KRA7401	Specific rear rack in aluminium for MONOKEY ® top case <i>maximum load allowed 6kg / it does not allow the assembly of the stop light kit or the remote control device on the case</i>	
 KLR7401	Specific rapid release side case holder for MONOKEY ® cases	
KLXR312	Specific rapid release side case holder for K33 MONOKEY ® SIDE cases	
 BF11K	Specific flange for fitting the tank bags with Tanklock system	
 KD272ST	Specific screen, transparent 60 x 47 cm (H x W) <i>9 cm higher than the original</i>	
 KN7401	Specific engine guard <i>we recommend fitting by a qualified mechanic / black colour / only for years 2011-2012</i>	
VARIOUS ACCESSORIES ES7401K	Specific support in aluminum and stainless steel to widen the surface support area of the original side stand	
DUCATI Multistrada 1200 (13 > 14)		
 KR312	Specific rear rack for MONOKEY ® top case MONOKEY ® plate included / is compatible with the original side case holder	
KRA7401	Specific rear rack in aluminium for MONOKEY ® top case <i>maximum load allowed 6kg / it does not allow the assembly of the stop light kit or the remote control device on the case</i>	
 KLR7401	Specific rapid release side case holder for MONOKEY ® cases	
KLXR312	Specific rapid release side case holder for K33 MONOKEY ® SIDE cases	
 BF11K	Specific flange for fitting the tank bags with Tanklock system	
 KD7401ST	Specific screen, transparent 56 x 42 cm (H x W)	
KD7401NO	Specific screen, matt black 35 x 28 cm (H x W)	
 KN7401	Specific engine guard <i>we recommend fitting by a qualified mechanic / black colour / only for years 2011-2012</i>	
VARIOUS ACCESSORIES ES7401K	Specific support in aluminum and stainless steel to widen the surface support area of the original side stand	



↘ = Item available until it runs out of stock













CODE	DESCRIPTION	PRICE
GILERA		
GILERA Runner 50-125-180 (99 > 00)		
KR125	Specific rear rack for MONOLOCK ® top case <i>to be combined with the plate already included in the MONOLOCK® top case</i>	
GILERA Runner 50-125-200 (04 > 05)		
KE6810	Specific rear rack for MONOLOCK ® top case <i>maximum load allowed 6Kg / to be combined with the plate already included in the MONOLOCK® top case / it is necessary to puncture the housing behind the saddle in arranged sections</i>	
GILERA Runner 50-125-200 (06 > 14)		
KR126	Specific rear rack for MONOLOCK ® top case <i>it is necessary to puncture the housing behind the saddle / maximum load allowed 3 Kg / to be combined with the plate already included in the MONOLOCK® top case</i>	
GILERA Nexus 125 - 250 - 300 - 500 (06 > 14)		
K682	Specific rear rack for MONOKEY ® top case <i>MONOKEY® plate included / it is necessary to puncture the housing behind the saddle / maximum load allowed 6Kg</i>	
K682M	Specific rear rack for MONOLOCK ® top case <i>MONOLOCK® plate included / it is necessary to puncture the housing behind the saddle / maximum load allowed 6Kg</i>	
KD351ST	Specific screen, transparent 65 x 50 cm (H x W) <i>to be mounted instead of the original screen / 24 cm higher than the original</i>	
GILERA Fuoco 500 (07 > 14)		
KE7100	Specific rear rack for MONOLOCK ® top case <i>to be combined with the plate already included in the MONOLOCK® top case</i>	
K710	Specific rear rack for MONOKEY ® top case <i>MONOKEY® plate included</i>	
340D	Specific screen, smoked 64,5 x 54,5 cm (H x W) <i>to be combined with the specific D340KIT fitting kit</i>	
D340KIT	Specific fitting kit for 340D	
GILERA Nexus 500 (03 > 04)		
K68	Specific rear rack for MONOKEY ® top case <i>MONOKEY® plate included / it is necessary to puncture the housing behind the saddle</i>	
K68M	Specific rear rack for MONOLOCK ® top case <i>MONOLOCK® plate included / it is necessary to puncture the housing behind the saddle</i>	
KD350ST	Specific screen, transparent 66 x 52 cm (H x W) <i>to be mounted instead of the original screen / 12 cm higher than the original</i>	
GILERA Nexus 500 (05)		
K682	Specific rear rack for MONOKEY ® top case <i>MONOKEY® plate included / it is necessary to puncture the housing behind the saddle / maximum load allowed 6Kg</i>	
K682M	Specific rear rack for MONOLOCK ® top case <i>MONOLOCK® plate included / it is necessary to puncture the housing behind the saddle / maximum load allowed 6Kg</i>	
KD350ST	Specific screen, transparent 66 x 52 cm (H x W) <i>to be mounted instead of the original screen / 12 cm higher than the original</i>	
GILERA GP 800 (08 > 14)		
T750K	Specific holder for soft side bags <i>it can be mounted only with the specific rear rack KR127 / KR127M</i>	
KD352ST	Specific screen, transparent 60 x 42 cm (H x W) <i>to be mounted instead of the original screen / 12 cm higher than the original</i>	
HONDA		
HONDA Zoomer 50 (Ruckus 50) (04 > 14)		
KR28	Specific rear rack for MONOLOCK ® top case <i>to be combined with the plate already included in the MONOLOCK® top case</i>	

MOTORCYCLE ACCESSORIES

CODE	DESCRIPTION	PRICE
 105A	Specific screen, transparent 66 x 67 cm (H x W) <i>to be combined with the specific A303A fitting kit/ With hand protectors</i>	
128A	Specific screen, transparent 74 x 67 cm (H x W) <i>to be combined with the specific A303A fitting kit/ 8 cm higher than 105A</i>	
HONDA Lead 100 (03 > 07)		
 259A	↘ Specific screen, transparent 48 x 47 cm (H x W) <i>to be combined with the specific A259A fitting kit</i>	
HONDA Lead 110 (08 > 14)		
 A314A	↘ Specific fitting kit for 314A	
HONDA Vision 50-110 (11 > 14)		
 KR1106	Specific rear rack for MONOLOCK ® top case <i>maximum load allowed 3 kg / to be combined with the plate already included in the MONOLOCK® top case</i>	
 308A	Specific screen, transparent with serigraphy 52 x 66,5 cm (H x W) <i>to be combined with the specific A1106A fitting kit</i>	
A1106A	Specific fitting kit for 308A	
HONDA Wave 110i (12 > 14)		
 KR1114	Specific rear rack for MONOLOCK ® or MONOKEY ® top case <i>to be combined with the K636 MONOKEY® plate, or with the plate already included in the MONOLOCK® top cases / maximum load allowed 6 kg</i>	
 1114A	Specific screen, transparent 43 x 46 cm (H x W) <i>to be combined with the specific A1114A fitting kit</i>	
A1114A	↘ Specific fitting kit for 1114A	
HONDA CBF 125 (09 > 14)		
 KR1570	Specific rear rack for MONOLOCK ® top case <i>maximum load allowed 6 kg / to be combined with the plate already included in the MONOLOCK® top case</i>	
 D317KIT	Specific fitting kit for 317DT	
 KN457	Specific engine guard <i>we recommend fitting by a qualified mechanic</i>	
HONDA CBR 125 (05 > 10)		
 KZ262	Specific rear rack for MONOKEY ® or MONOLOCK ® top case <i>to be combined with the MONOKEY® KM5 or KM7 plates, or with the MONOLOCK® KM5M or KM6M plates</i>	
HONDA CBR 125 R (11 > 14)		
 KR1103	Specific rear rack for MONOLOCK ® top case <i>maximum load allowed 6 kg / to be combined with the plate already included in the MONOLOCK® top case</i>	
HONDA Innova 125 (07 > 14)		
 KR151	↘ Specific rear rack for MONOLOCK ® top case <i>to be combined with the plate already included in the MONOLOCK® top case</i>	
HONDA PCX 125-150 (10 > 13)		
 KR1136	Specific rear rack for MONOLOCK ® top case <i>to be combined with the plate already included in the MONOLOCK® top case</i>	
 323DT	Specific screen, transparent 82 x 58 cm (H x W) <i>to be combined with the specific D323KIT fitting kit/ 41 cm higher than original</i>	
D323KIT	Specific fitting kit for 323DT	
KD322ST	Specific screen, transparent, 59,5 x 44 cm (H x W) <i>to be mounted instead of the original screen / 18,5 cm higher than original</i>	
KD322S	Specific screen, smoked, 59,5 x 44 cm (H x W) <i>to be mounted instead of the original screen</i>	



↘ = Item available until it runs out of stock













CODE	DESCRIPTION	PRICE
HONDA	PCX 125-150 (14) NEW	
 KR1136	Specific rear rack for MONOLOCK ® top case <i>to be combined with the plate already included in the MONOLOCK® top case</i>	
 KD1136ST	Specific screen, transparent 63,0 x 43,5 cm (H x W) <i>to be mounted instead of the original screen</i>	
HONDA	@ 125-150 (00 > 03)	
 183A	↘ Specific screen, transparent 67,9 x 66,5 cm (H x W) <i>to be combined with the specific A183A fitting kit</i>	
HONDA	@ 125-150 (04 > 08)	
 183A	↘ Specific screen, transparent 67,9 x 66,5 cm (H x W) <i>to be combined with the specific A301A fitting kit</i>	
HONDA	Dylan 125-150 (02 > 07)	
 KR22	Specific rear rack for MONOLOCK ® or MONOKEY ® top case <i>to be combined with the K636 MONOKEY® plate, or with the plate already included in the MONOLOCK® top cases / in replacement of original rack</i>	
 102A	Specific screen, transparent 66 x 68 cm (H x W) <i>to be combined with the specific A185A fitting kit / With hand protectors</i>	
128A	Specific screen, transparent 74 x 67 cm (H x W) <i>to be combined with the specific A185A fitting kit / 8 cm higher than 105A</i>	
A185A	Specific fitting kit for 128A and 102A	
HONDA	Pantheon 125-150 (98 > 02)	
 KR140	Specific rear rack for MONOLOCK ® or MONOKEY ® top case <i>to be combined with the K636 MONOKEY® plate, or with the plate already included in the MONOLOCK® top cases</i>	
 KD199ST	Specific screen, transparent 49,9 x 72,5 cm (H x W) <i>to be mounted instead of the original screen</i>	
KD199S	↘ Specific wind-screen, smoked colour (H x W) 49,9 cm x 72,5 cm <i>to be mounted instead of the original screen</i>	
KD202ST	Specific screen, transparent 60 x 74,4 cm (H x W) <i>to be mounted instead of the original screen / 10 cm higher than KD199ST and KD199S</i>	
D199KIT	Kit for a better anchorage of the spoilers: KD199S, KD199ST and KD202ST	
HONDA	Pantheon 125-150 (03 > 08)	
 KE2160	↘ Specific rear rack for MONOLOCK ® top case <i>to be combined with the plate already included in the MONOLOCK® top case</i>	
 KD219ST	Specific screen, transparent 63 x 72,5 cm (H x W) <i>to be mounted instead of the original screen / With hand protectors</i>	
HONDA	SH 125-150 (01 > 04)	
 186A	Specific screen, transparent 58 x 68 cm (H x W) <i>to be combined with the specific A186A fitting kit</i>	
A186A	Specific fitting kit for 186A	
VARIOUS ACCESSORIES	KTB21 ↘ Specific backrest	
HONDA	SH 125i-150i (05 > 08)	
 KE2190	Specific rear rack for MONOLOCK ® top case <i>to be combined with the plate already included in the MONOLOCK® top case</i>	
 311A	Specific screen, transparent 62 x 67,5 cm (H x W) <i>to be combined with the specific A311A fitting kit / With hand protectors / in order to install it use the fitting kit A311A</i>	
313A	Specific screen, transparent 55 x 66 cm (H x W) <i>to be combined with the specific A311A fitting kit / In order to install the screen you must combine it with the kit A311A / With hand protectors</i>	
A311A	Specific fitting kit for 311A, 313A	
304A	↘ Specific screen, transparent 63 x 70 cm (H x W) <i>to be combined with the specific A304A fitting kit</i>	

MOTORCYCLE ACCESSORIES

CODE	DESCRIPTION	PRICE
A304A	↘ Specific fitting kit for 304A, 304AS	
304AS	↘ Specific screen, transparent with serigraphy (H x W) 63 cm x 70 cm to be combined with the specific A304A fitting kit	
HONDA SH 125i-150i (09 > 12)		
 KE2270	Specific rear rack for MONOLOCK ® top case to be combined with the plate already included in the MONOLOCK ® top case / maximum load allowed 3 kg	
 311A	Specific screen, transparent 62 x 67,5 cm (H x W) to be combined with the specific A315A fitting kit/ In order to install it you need the fitting kit A311A / with hand protectors	
313A	Specific screen, transparent 55 x 66 cm (H x W) to be combined with the specific A315A fitting kit/ With hand protectors / you need the fitting kit A311A	
A315A	Specific fitting kit for 311A and 313A	
HONDA SH 125i-150i ABS (12 > 14)		
 KE2270	Specific rear rack for MONOLOCK ® top case to be combined with the plate already included in the MONOLOCK ® top case / maximum load allowed 3 kg	
 1117A	Specific screen, transparent 59 x 71,5 cm (H x W) to be combined with the specific A1117A fitting kit	
1128A	Specific wind-screen replacement to be fixed with original Honda fitting kit It does not protect the hand area	
A1117A	Kit di attacchi specifico per 1117A	
HONDA SH MODE 125 (13 > 14) NEW		
 KR1125	Specific rear rack for MONOLOCK ® top case to be combined with the plate already included in the MONOLOCK ® top case	
 1125A	Specific screen, transparent to be combined with the specific A110A fitting kit	
A1125A	Specific fitting kit for 1125A	
HONDA S-Wing 125-150 (07 > 12)		
 KE2240	Specific rear rack for MONOLOCK ® top case to be combined with the plate already included in the MONOLOCK ® top case	
 KD312ST	Specific screen, transparent 89 x 54 cm (H x W) to be mounted instead of the original screen	
HONDA XL 125V Varadero (01 > 06)		
 KE2170	Specific rear rack for MONOLOCK ® top case maximum load allowed 5 Kg / to be combined with the plate already included in the MONOLOCK ® top case	
K213	Specific rear rack for MONOKEY ® top case MONOKEY ® plate included	
 KL173	Specific pannier holder for MONOKEY ® side cases	
 KD215S	Specific screen, smoked 49,9 x 33,2 cm (H x W)	
HONDA XL 125V Varadero (07 > 14)		
 KE2170	Specific rear rack for MONOLOCK ® top case maximum load allowed 5 Kg / to be combined with the plate already included in the MONOLOCK ® top case	
K213	Specific rear rack for MONOKEY ® top case MONOKEY ® plate included	
 KL202	Specific pannier holder for MONOKEY ® side cases	
 KD311S	Specific screen, smoked 46 x 33 cm (H x W) 19 cm higher than original	
VARIOUS ACCESSORIES 03SKIT	Specific kit to mounting the KS900A Smart Bar	
HONDA CBF 250 (04 > 06)		
 KZ261	Specific rear rack for MONOKEY ® or MONOLOCK ® top case to be combined with the MONOKEY ® KM5 or KM7 plates, or with the MONOLOCK ® KM5M or KM6M plates / maximum load allowed 6 kg / black colour	



↘ = Item available until it runs out of stock

CODE	DESCRIPTION	PRICE
HONDA CBR 250 R (11 > 14)		
 KR1103	Specific rear rack for MONOLOCK ® top case <i>maximum load allowed 6 kg / to be combined with the plate already included in the MONOLOCK® top case</i>	
HONDA Foresight 250 (97 > 08)		
 KR140	Specific rear rack for MONOLOCK ® or MONOKEY ® top case <i>to be combined with the K636 MONOKEY® plate, or with the plate already included in the MONOLOCK® top cases</i>	
 KD199ST	Specific screen, transparent 49,9 x 72,5 cm (H x W) <i>to be mounted instead of the original screen</i>	
KD199S	Specific wind-screen, smoked colour (H x W) 49,9 cm x 72,5 cm <i>to be mounted instead of the original screen</i>	
KD202ST	Specific screen, transparent 60 x 74,4 cm (H x W) <i>to be mounted instead of the original screen / 10 cm higher than KD199ST and KD199S</i>	
D199KIT	Kit for a better anchorage of the spoilers: KD199S, KD199ST and KD202ST	
HONDA Forza 250 (05 > 07)		
 K22	Specific rear rack for MONOKEY ® top case MONOKEY ® plate included / in order to fix you must remove the original backrest	
K22M	Specific rear rack for MONOLOCK ® top case MONOLOCK ® plate included / in order to fix you must remove the original backrest	
 KD306ST	Specific screen, transparent 73 x 61,5 cm (H x W) <i>to be mounted instead of the original screen / 34 cm higher than the original</i>	
HONDA Forza 250 X / EX (08 > 12)		
 K226	Specific rear rack for MONOKEY ® top case MONOKEY ® plate included / it is necessary to puncture the housing behind the saddle in arranged sections / maximum load allowed 6 Kg	
K226M	Specific rear rack for MONOLOCK ® top case MONOLOCK ® plate included / it is necessary to puncture the housing behind the saddle in arranged sections / maximum load allowed 6 Kg	
 D315KIT	Specific fitting kit for 315DT	
HONDA Forza 300 ABS (13 > 14)		
 KR1123	Specific rear rack for MONOKEY ® top case <i>maximum load allowed 6 kg / MONOKEY® plate included</i>	
KR1123MM	Specific rear rack for MONOLOCK ® top case MONOLOCK ® plate with place for the "u" type padlock included	
 KD1123ST	Specific screen, transparent 73 x 59 cm (H x W) <i>to be mounted instead of the original screen / 21 cm higher than the original</i>	
KAF1123	Specific sliding wind-screen transparent, AIRSTREAM for Honda Forza 300 ABS (13). Maximum height 71 cm (12 cm of extension), width 58 cm <i>to be mounted instead of the original screen</i>	
HONDA SH 300i (07 > 10)		
 KE2230	Specific rear rack for MONOLOCK ® top case <i>to be combined with the plate already included in the MONOLOCK® top case</i>	
 307A	Specific screen, transparent with serigraphy 58,5 x 68 cm (H x W) <i>to be combined with the specific A307A fitting kit</i>	
308A	Specific screen, transparent with serigraphy 52 x 66,5 cm (H x W) <i>to be combined with the specific A307A fitting kit</i>	
A307A	Specific fitting kit for 307A and 308A <i>Black colour</i>	
KAF308	Specific Airstream sliding wind-screen transparent. Maximum height 48 cm (12 cm of extension) width 67 cm <i>complete with specific fitting kit / to be mounted instead of the original screen</i>	
HONDA SH 300i (11 > 14)		
 KE2230	Specific rear rack for MONOLOCK ® top case <i>to be combined with the plate already included in the MONOLOCK® top case</i>	
 307A	Specific screen, transparent with serigraphy 58,5 x 68 cm (H x W) <i>to be combined with the specific A1100A fitting kit</i>	
A1100A	Specific fitting kit for 307A and 308A	
308A	Specific screen, transparent with serigraphy 52 x 66,5 cm (H x W) <i>to be combined with the specific A1100A fitting kit</i>	
KAF1100	Specific Airstream sliding wind-screen transparent. Maximum height 48 cm (12 cm of extension), width 67 cm <i>complete with specific fitting kit</i>	

MOTORCYCLE ACCESSORIES



CODE	DESCRIPTION	PRICE
HONDA Silver Wing 400 (06 > 09)		
 KR19	Specific rear rack for MONOKEY ® top case MONOKEY ® plate included / you must puncture the original case holder / it is necessary to puncture the housing behind the saddle in arranged sections	
KR19M	Specific rear rack for MONOLOCK ® top case MONOLOCK ® plate included / you must puncture the original case holder / it is necessary to puncture the housing behind the saddle in arranged sections	
 214DT	Specific screen, transparent 63 x 60 cm (H x W) to be combined with the specific D214KIT fitting kit/ 10 cm higher than the original	
D214KIT	Specific fitting kit for 214DT	
KAF214	Specific Airstream sliding wind-screen transparent. Maximum height 57 cm (12 cm of extension) width 59cm complete with specific fitting kit / to be mounted instead of the original screen	
VARIOUS ACCESSORIES KTB19	Specific backrest It can be mounted with the KR19, KR19M	
HONDA SW-T 400/600 (09 > 14)		
 KR19	Specific rear rack for MONOKEY ® top case MONOKEY ® plate included / you must puncture the original case holder / it is necessary to puncture the housing behind the saddle in arranged sections	
KR19M	Specific rear rack for MONOLOCK ® top case MONOLOCK ® plate included / you must puncture the original case holder / it is necessary to puncture the housing behind the saddle in arranged sections	
 TK222	↘ Specific holder for soft side bags	
 KD318ST	Specific screen, transparent, 89 x 67 cm (H x W) to be mounted instead of the original screen / 18 cm higher than the original	
KAF318	Specific Airstream sliding wind-screen, transparent, complete with fitting kit. Maximum height 78 cm (12 cm of extension) width 66 cm complete with specific fitting kit / to be mounted instead of the original screen	
VARIOUS ACCESSORIES KTB19	Specific backrest It can be mounted with the KR19, KR19M	
HONDA CB 500 (94)		
 K2410	↘ Specific rear rack for MONOKEY ® or MONOLOCK ® top case To be combined with the plate MONOKEY ® K553N, or with the plate MONOLOCK ® MKN	
HONDA CB 500 (97 > 05) / CB 500S (00 > 05)		
 K2500	Specific rear rack for MONOKEY ® or MONOLOCK ® top case To be combined with the plate MONOKEY ® K553N, or with the plate MONOLOCK ® MKN	
HONDA CB 500 F (13 > 14)		
 KR1119	Specific rear rack for MONOLOCK ® top case to be combined with the plate already included in the MONOLOCK ® top case	
 KL1119	Specific pannier holder for MONOKEY ® side cases it can be mounted only with the specific rear rack KR1119/ you can only mount cases MONOKEY ® K21	
KLX1119	Specific pannier holder for K33 MONOKEY ® SIDE cases it can be mounted only with the specific rear rack KR1119	
 TE1119K	Specific holder for soft side bags it can be mounted only with the specific rear rack KR1119	
 KA1126	Specific screen, smoked 28.5 x 36 cm (H x W) complete with specific fitting kit	
HONDA CBF 500 (04 > 12)		
 KZ260	Specific rear rack for MONOKEY ® or MONOLOCK ® top case to be combined with the MONOKEY ® KM5 or KM7 plates, or with the MONOLOCK ® KMSM or KM6M plates / It is not compatible with the original side-case holder	
 KL174	Specific pannier holder for MONOKEY ® side cases	
KLXR174	Specific rapid release side case holder for K33 MONOKEY ® SIDE cases	
KLX174	Specific pannier holder for K33 MONOKEY ® SIDE cases it can be mounted without the specific rear rack KZ260 using the PLX174KIT	
PLX174KIT	Specific kit to install the KLX without the rack for the top case	
 TK218	Specific holder for soft side bags	
HONDA CBR 500 R (13 > 14)		
 KR1119	Specific rear rack for MONOLOCK ® top case to be combined with the plate already included in the MONOLOCK ® top case	



↘ = Item available until it runs out of stock

















CODE	DESCRIPTION	PRICE
KL1119	Specific pannier holder for MONOKEY ® side cases <i>it can be mounted only with the specific rear rack KR1119/you can only mount cases MONOKEY® K21</i>	
KLX1119	Specific pannier holder for K33 MONOKEY ® SIDE cases <i>it can be mounted only with the specific rear rack KR1119</i>	
TE1119K	Specific holder for soft side bags <i>it can be mounted only with the specific rear rack KR1119</i>	
HONDA CB 500 X (13 > 14)		
KZ1121	Specific rear rack for MONOKEY ® or MONOLOCK ® top case <i>to be combined with the MONOKEY® KMS or KM7 plates, or with the MONOLOCK® KMSM or KM6M plates / maximum load allowed 6 kg</i>	
KL1121	Specific pannier holder for MONOKEY ® side cases <i>you can only mount cases Garda KGR33, Garda KGR46, K21 e K22 it can be mounted without the specific rear rack KZ1121 using the 1121KIT /To ensure the best visibility of the rear indicators mounted with the cases, you need to relocate them by using kit IN1121KIT.</i>	
IN1121KIT	Specific kit to move the indicators to ensure the highest visibility with the fitted cases <i>is not necessary if you have the K21N e K22N</i>	
KLX1121	Specific pannier holder for K33 MONOKEY ® SIDE cases	
1121KIT	Specific kit to install the KLX1121 without the specific rear rack KZ1121	
KD1121ST	Specific screen, transparent 49 x 35 cm (H x W) <i>to be mounted instead of the original screen / 19 cm higher than original</i>	
KN1121	Specific engine guard <i>we recommend fitting by a qualified mechanic / black colour</i>	
VARIOUS ACCESSORIES ES1121K	Specific support in aluminum and stainless steel to widen the surface support area of the original side stand	
02SKIT	Specific kit to mounting the KS900A Smart Bar	
KHP1121	Hand protector specific ABS	
KMG1121	Mudguard/specific ABS chain-cover, black colour	
HONDA CBF 600S/ CBF 600N (04 > 12)		
KZ260	Specific rear rack for MONOKEY ® or MONOLOCK ® top case <i>to be combined with the MONOKEY® KMS or KM7 plates, or with the MONOLOCK® KMSM or KM6M plates / It is not compatible with the original side-case holder</i>	
KL174	Specific pannier holder for MONOKEY ® side cases	
KLXR174	Specific rapid release side case holder for K33 MONOKEY ® SIDE cases	
KLX174	Specific pannier holder for K33 MONOKEY ® SIDE cases <i>it can be mounted without the specific rear rack KZ260 using the PLX174KIT</i>	
PLX174KIT	Specific kit to install the KLX without the rack for the top case	
TK218	Specific holder for soft side bags	
BF03K	Specific flange for fitting the tank bags with Tanklock system	
KD303ST	Specific screen, transparent 54 x 39,5 cm (H x W) <i>12,5 cm higher than original / only for faired models</i>	
KN369	Specific engine guard <i>we recommend fitting by a qualified mechanic / compatible with all years '07</i>	
KN456	Specific engine guard <i>we recommend fitting by a qualified mechanic / compatible from '08</i>	
HONDA CBR 600 F (97 > 98)		
K2490	Specific rear rack for MONOKEY ® or MONOLOCK ® top case <i>To be combined with the plate MONOKEY® K553N, or with the plate MONOLOCK® MKN</i>	
HONDA CBR 600 F (99 > 09)		
K2520	Specific rear rack for MONOKEY ® or MONOLOCK ® top case <i>To be combined with the plate MONOKEY® K553N, or with the plate MONOLOCK® MKN</i>	
KD204S	Specific screen, fumè 38,9 x 41,1 cm (H x W) <i>compatible with '99 and '00</i>	

MOTORCYCLE ACCESSORIES























CODE	DESCRIPTION	PRICE
HONDA CBR 600 F (11 > 13) NEW		
 KZ1102	Specific rear rack for MONOKEY ® or MONOLOCK ® top case to be combined with the MONOKEY ® KM5 or KM7 plates, or with the MONOLOCK ® KM5M or KM6M plates	
 KLX1102	Specific pannier holder for K33 MONOKEY ® SIDE cases it can be mounted without the specific rear rack KZ1102 using the 1102KIT	
1102KIT	Specific kit to install the TE1102K and KLX1102 without the specific rear rack	
 TE1102K	Specific holder for soft side bags it can be mounted without the specific rear rack KZ1102 using the 1102KIT	
 BF03K	Specific flange for fitting the tank bags with Tanklock system	
 1105D	↘ Specific screen, smoked 39,5 x 36 cm (H x W) to be combined with the specific D1105KIT fitting kit/ abbinareagli attacchi D1105KIT / 5 cm higher than the original	
D1105KIT	Specific fitting kit for 1105D	
HONDA CBR 600 RR (05 > 06)		
 BF03K	Specific flange for fitting the tank bags with Tanklock system	
HONDA CBR 600 RR (07 > 09)		
 BF03K	Specific flange for fitting the tank bags with Tanklock system	
HONDA CBR 600 RR (13 > 14)		
 KD1122S	↘ Specific screen, smoked 25 x 30 cm (H x W) to be mounted instead of the original screen	
HONDA Hornet 600 / S (98 > 02)		
 KZ162	Specific rear rack for MONOKEY ® or MONOLOCK ® top case to be combined with the MONOKEY ® KM5 or KM7 plates, or with the MONOLOCK ® KM5M or KM6M plates	
 TK214	Specific holder for soft side bags	
HONDA Hornet 600 (03 > 06)		
 KZ258	Specific rear rack for MONOKEY ® or MONOLOCK ® top case to be combined with the MONOKEY ® KM5 or KM7 plates, or with the MONOLOCK ® KM5M or KM6M plates / Bronze colour	
 TK214	Specific holder for soft side bags	
 KA305	Specific screen, fumè 31,2 x 40,8 cm (H x W) including fixing kit / it can be installed without taking off the original light fairing / compatible with models from '05 to '06	
HONDA Hornet 600 / Hornet 600 ABS (07 > 10)		
 KZ263	Specific rear rack for MONOKEY ® or MONOLOCK ® top case to be combined with the MONOKEY ® KM5 or KM7 plates, or with the MONOLOCK ® KM5M or KM6M plates / you must remove the original grab handles they are reproduced by the rack itself	
 TE1107K	Specific holder for soft side bags	
TK219	Specific holder for soft side bags	
 BF03K	Specific flange for fitting the tank bags with Tanklock system	
 KA309	Specific screen, fumè 33,5 x 40,5 cm (H x W) including fixing kit / only for CB 600 F Hornet	
KA310	Specific screen, fumè 33,5 x 40,5 cm (H x W) including fixing kit / only for Hornet ABS	
 KN453	Specific engine guard we recommend fitting by a qualified mechanic	
VARIOUS ACCESSORIES 02SKIT	Specific kit to mounting the KS900A Smart Bar	
HONDA Hornet 600 (11 > 13)		
 KZ1102	Specific rear rack for MONOKEY ® or MONOLOCK ® top case to be combined with the MONOKEY ® KM5 or KM7 plates, or with the MONOLOCK ® KM5M or KM6M plates	



↘ = Item available until it runs out of stock

















CODE	DESCRIPTION	PRICE
 KLX1102	Specific pannier holder for K33 MONOKEY® SIDE cases <i>it can be mounted without the specific rear rack KZ1102 using the 1102KIT</i>	
1102KIT	Specific kit to install the TE1102K and KLX1102 without the specific rear rack	
 TE1102K	Specific holder for soft side bags <i>it can be mounted without the specific rear rack KZ1102 using the 1102KIT</i>	
 BF03K	Specific flange for fitting the tank bags with Tanklock system	
 KA1102	Specific screen, smoked 28,5 x 36 cm (H x W) <i>Complete with fitting kit</i>	
 KN453	Specific engine guard <i>we recommend fitting by a qualified mechanic</i>	
VARIOUS ACCESSORIES O2SKIT	Specific kit to mounting the KS900A Smart Bar	
HONDA Silver Wing 600 / ABS (01 > 09)		
 KR19	Specific rear rack for MONOKEY® top case MONOKEY® plate included / you must puncture the original case holder / it is necessary to puncture the housing behind the saddle in arranged sections	
KR19M	Specific rear rack for MONOLOCK® top case MONOLOCK® plate included / you must puncture the original case holder / it is necessary to puncture the housing behind the saddle in arranged sections	
 214DT	Specific screen, transparent 63 x 60 cm (H x W) <i>to be combined with the specific D214KIT fitting kit/ 10 cm higher than the original</i>	
D214KIT	Specific fitting kit for 214DT	
KAF214	Specific Airstream sliding wind-screen transparent. Maximum height 57 cm (12 cm of extension) width 59cm <i>complete with specific fitting kit / to be mounted instead of the original screen</i>	
VARIOUS ACCESSORIES KTB19	Specific backrest <i>It can be mounted with the KR19, KR19M</i>	
HONDA VT 600 C Shadow (89 > 01)		
 A35N	Universal screen, 54,9 x 46,8 cm (H x W) <i>to be combined with the specific AS100A2 fitting kit</i>	
23A	Universal screen, 38,8 x 41 cm (H x W) <i>to be combined with the specific AS100A2 fitting kit</i>	
AS100A2	Specific fitting kit for 23A and A35N	
HONDA XL 600 RM/LM		
 K200	Specific rear rack for MONOKEY® top case MONOKEY® plate included	
HONDA XL 600 V Transalp (88)		
 K200	Specific rear rack for MONOKEY® top case MONOKEY® plate included	
HONDA XL 600 V Transalp (89 > 93)		
 K200	Specific rear rack for MONOKEY® top case MONOKEY® plate included	
 KD180S	Specific screen, smoked 43,7 x 43,9 cm (H x W)	
 KN22	Specific engine guard <i>we recommend fitting by a qualified mechanic</i>	
HONDA XL 600 V Transalp (94 > 96)		
 K200	Specific rear rack for MONOKEY® top case MONOKEY® plate included	
 KL131	Specific pannier holder for MONOKEY® side cases	
 KD191S	Specific screen, smoked 44,1 x 38,4 cm (H x W)	
 KN22	Specific engine guard <i>we recommend fitting by a qualified mechanic</i>	

MOTORCYCLE ACCESSORIES



















CODE	DESCRIPTION	PRICE
HONDA XL 600 V Transalp (97 > 99)		
 KL131	Specific pannier holder for MONOKEY ® side cases	
 KD191S	Specific screen, smoked 44,1 x 38,4 cm (H x W)	
 KN22	Specific engine guard <i>we recommend fitting by a qualified mechanic</i>	
HONDA CB 650 F (14) / CBR 650 F (14) NEW		
 KZ1137	Specific rear rack for MONOKEY ® or MONOLOCK ® top case <i>to be combined with the MONOKEY® KM5 or KM7 plates, or with the MONOLOCK® KM5M or KM6M plates</i>	
 KLX1137	Specific pannier holder for K33 MONOKEY ® SIDE cases <i>it can be mounted without the specific rear rack KZ1137 using the 1137KIT</i>	
 BF20K	Specific flange for fitting the tank bags with Tanklock system	
 TE1137K	Specific holder for soft side bags <i>it can be mounted without the specific rear rack KZ1137 using the 1137KIT</i>	
 1137KIT	Specific kit to install the KLX1137 or TE1137K without the specific rear rack KZ1137	
 KA1137	Specific screen, black 28.5 x 36 cm (H x W) <i>Complete with fitting kit. Only for CB650F</i>	
 KD1138S	Specific screen, transparent <i>only for CBR650F / to be mounted instead of the original screen / 5 cm higher than original</i>	
VARIOUS ACCESSORIES 02SKIT	Specific kit to mounting the KS900A Smart Bar <i>only for CBR650 F</i>	
HONDA Dominator 650 (< 92)		
 K200	Specific rear rack for MONOKEY ® top case MONOKEY ® plate included	
HONDA Dominator 650 (92 > 94)		
 K200	Specific rear rack for MONOKEY ® top case MONOKEY ® plate included	
HONDA NT 650 V Deauville (98 > 05)		
 KR15	Specific rear rack for MONOKEY ® top case MONOKEY ® plate included	
 KR15M	Specific rear rack for MONOLOCK ® top case MONOLOCK ® plate included	
 KD201S	Specific screen, smoked 45 x 40,3 cm (H x W)	
HONDA XL 650V Transalp (00 > 07)		
 K213	Specific rear rack for MONOKEY ® top case MONOKEY ® plate included	
 KL167	Specific pannier holder for MONOKEY ® side cases	
 TK213	Specific holder for soft side bags	
 KD209S	Specific screen, smoked 56 x 36 cm (H x W)	
 KN26	Specific engine guard <i>It can be mounted with the central stand installed / we recommend fitting by a qualified mechanic</i>	
HONDA CTX 700 DCT (14) NEW		
 KZ1133	Specific rear rack for MONOKEY ® or MONOLOCK ® top case <i>to be combined with the MONOKEY® KM5 or KM7 plates, or with the MONOLOCK® KM5M or KM6M plates</i>	
 KD1133ST	Specific screen, transparent 48 x 62 cm (h x w) <i>to be mounted instead of the original screen</i>	
HONDA CTX 700N DCT (14) NEW		
 KZ1131	Specific rear rack for MONOKEY ® or MONOLOCK ® top case <i>to be combined with the MONOKEY® KM5 or KM7 plates, or with the MONOLOCK® KM5M or KM6M plates</i>	



↘ = Item available until it runs out of stock













CODE	DESCRIPTION	PRICE
HONDA DN-01 700 (08 > 14)		
 KZ265	Specific rear rack for MONOKEY ® or MONOLOCK ® top case to be combined with the MONOKEY ® KM5 or KM7 plates, or with the MONOLOCK ® KM5M or KM6M plates / maximum load allowed 6 kg / black colour / it is necessary to puncture the housing behind the saddle	
 KLX204	Specific pannier holder for K33 MONOKEY ® SIDE cases it can be mounted only with the specific rear rack KZ265	
 KD316S	Specific screen, smoked 66 x 45 cm (H x W)	
HONDA Integra 700 (12 > 13)		
 KZ1109	Specific rear rack for MONOKEY ® or MONOLOCK ® top case to be combined with the MONOKEY ® KM5 or KM7 plates, or with the MONOLOCK ® KM5M or KM6M plates	
 KLX1120	Specific pannier holder for K33 MONOKEY ® SIDE cases it can be mounted only with the original luggage carrier Honda	
KLX1109	Specific pannier holder for K33 MONOKEY ® SIDE cases it can be mounted without the specific rear rack KZ1109 using the 1109KIT	
KL1109	Specific pannier holder for MONOKEY ® side cases it can be mounted without the specific rear rack KZ1109 using the 1109KIT	
1109KIT	Specific kit to install the KLX1109 / KL1109 / TE1109K without the specific rear rack	
 TE1109K	Specific holder for soft side bags it can be mounted without the specific rear rack KZ1109 using the 1109KIT	
 KD1109ST	Specific screen, transparent 72 x 69 cm (H x W) to be mounted instead of the original screen / 11 cm higher than the original wind-screen	
KD1109B	Specific low and sports screen gloss black 47 x 43 cm (H x W)	
VARIOUS ACCESSORIES KMG1109	Mudguard/specific ABS chain-cover, black colour	
ES1121K	Specific support in aluminum and stainless steel to widen the surface support area of the original side stand	
HONDA NC 700S (12 > 13) / NC 750 S (14) NEW		
 KZ1111	Specific rear rack for MONOKEY ® or MONOLOCK ® top case to be combined with the MONOKEY ® KM5 or KM7 plates, or with the MONOLOCK ® KM5M or KM6M plates	
 KLX1111	Specific pannier holder for K33 MONOKEY ® SIDE cases it can be mounted without the specific rear rack KZ1111 using the 1111KIT	
KL1111	Specific pannier holder for MONOKEY ® side cases it can be mounted without the specific rear rack KZ1111 using the 1111KIT	
1111KIT	Specific kit to install the TE1111K/KL1111/KLX1111 without the specific rear rack	
 TE1111K	Specific holder for soft side bags it can be mounted without the specific rear rack KZ1111 using the 1111KIT	
 KD1112S	Specific screen, smoked 31 x 36 cm (H x W) 6.5 cm higher than original	
 KN1111	Specific engine guard we recommend fitting by a qualified mechanic	
VARIOUS ACCESSORIES KMG1109	Mudguard/specific ABS chain-cover, black colour	
ES1121K	Specific support in aluminum and stainless steel to widen the surface support area of the original side stand	
02SKIT	Specific kit to mounting the KS900A Smart Bar	
HONDA NC 700X (12 > 13) / NC 750 X (14) NEW		
 KZ1111	Specific rear rack for MONOKEY ® or MONOLOCK ® top case to be combined with the MONOKEY ® KM5 or KM7 plates, or with the MONOLOCK ® KM5M or KM6M plates	
 KLX1111	Specific pannier holder for K33 MONOKEY ® SIDE cases it can be mounted without the specific rear rack KZ1111 using the 1111KIT	
KL1111	Specific pannier holder for MONOKEY ® side cases it can be mounted without the specific rear rack KZ1111 using the 1111KIT	
 TE1111K	Specific holder for soft side bags it can be mounted without the specific rear rack KZ1111 using the 1111KIT	
 1111KIT	Specific kit to install the TE1111K/KL1111/KLX1111 without the specific rear rack	
 KD1111ST	Specific screen, transparent 49,5 x 41 cm (H x W) 16.5 cm higher than the original	
VARIOUS ACCESSORIES KHP1111	Hand protector specific ABS	

MOTORCYCLE ACCESSORIES

















CODE	DESCRIPTION	PRICE
 KN1111	Specific engine guard <i>we recommend fitting by a qualified mechanic</i>	
VARIOUS ACCESSORIES KMG1109	Mudguard/specific ABS chain-cover, black colour	
ES1121K	Specific support in aluminum and stainless steel to widen the surface support area of the original side stand	
02SKIT	Specific kit to mounting the KS900A Smart Bar	
HONDA NT 700 Deauville (06 > 12)		
 K221	Specific rear rack for MONOKEY ® top case MONOKEY ® plate included/ for fixing the original lid must be drilled / it is necessary to puncture the housing behind the saddle	
K221M	Specific rear rack for MONOLOCK ® top case MONOLOCK ® plate included / for fixing the original lid must be drilled / it is necessary to puncture the housing behind the saddle	
 BF03K	Specific flange for fitting the tank bags with Tanklock system	
 KD307ST	Specific screen, transparent 49 x 46,5 cm (H x W) <i>9 cm higher than the original</i>	
HONDA XL 700V Transalp (08 > 13)		
 K225	Specific rear rack for MONOKEY ® top case MONOKEY ® plate included	
K225M	Specific rear rack for MONOLOCK ® top case MONOLOCK ® plate included	
 KL203	Specific pannier holder for MONOKEY ® side cases	
 TK221	Specific holder for soft side bags	
 BF03K	Specific flange for fitting the tank bags with Tanklock system	
 KD313S	Specific screen, smoked 44,5 x 37 cm (H x W) <i>15,5 cm higher than original</i>	
 KN455	Specific engine guard <i>we recommend fitting by a qualified mechanic</i>	
VARIOUS ACCESSORIES ES1121K	Specific support in aluminum and stainless steel to widen the surface support area of the original side stand	
HONDA Africa Twin 750 (90 > 92)		
 K200	Specific rear rack for MONOKEY ® top case MONOKEY ® plate included	
HONDA Africa Twin 750 (93 > 95)		
 K210	Specific rear rack for MONOKEY ® top case MONOKEY ® plate included	
 KL148	Specific pannier holder for MONOKEY ® side cases	
 KN23	Specific engine guard <i>compatible with model '95 we recommend fitting by a qualified mechanic / black colour / compatible only with 2005 version</i>	
HONDA Africa Twin 750 (96 > 02)		
 K210	Specific rear rack for MONOKEY ® top case MONOKEY ® plate included	
 KL148	Specific pannier holder for MONOKEY ® side cases	
 KD195S	Specific screen, smoked 44 x 35 cm (H x W)	
 KN23	Specific engine guard <i>we recommend fitting by a qualified mechanic / black colour / compatible only with 2005 version</i>	
HONDA Black Widow 750 (00 > 02)		
 A35N	Universal screen, 54,9 x 46,8 cm (H x W) <i>to be combined with the specific AS100A2 fitting kit</i>	
23A	Universal screen, 38,8 x 41 cm (H x W) <i>to be combined with the specific AS100A2 fitting kit</i>	



↘ = Item available until it runs out of stock

CODE	DESCRIPTION	PRICE
AS100A2	Specific fitting kit for 23A and A35N	
HONDA CB 750 Seven Fifty (92 > 00)		
 K2320	Specific rear rack for MONOKEY ® or MONOLOCK ® top case <i>To be combined with the plate MONOKEY® K553N, or with the plate MONOLOCK® MKN</i>	
HONDA Integra 750 (14) NEW		
 KZ1127	Specific rear rack for MONOKEY ® or MONOLOCK ® top case <i>to be combined with the MONOKEY® KM5 or KM7 plates, or with the MONOLOCK® KM5M or KM6M plates / maximum load allowed 6 kg</i>	
 KLX1127	Specific pannier holder for K33 MONOKEY ® SIDE cases <i>it can be mounted without the specific rear rack KZ1127 using the 1127KIT</i>	
1127KIT	Specific kit to install the KLX1127 without the specific rear rack KZ1127	
 KD1109ST	Specific screen, transparent 72 x 69 cm (H x W) <i>to be mounted instead of the original screen / 11 cm higher than the original wind-screen</i>	
KD1109B	Specific low and sports screen gloss black 47 x 43 cm (H x W)	
VARIOUS ACCESSORIES KMG1127	Mudguard/specific ABS chain-cover, black colour	
HONDA VFR 750 F (90 > 93)		
 K2290	Specific rear rack for MONOKEY ® or MONOLOCK ® top case <i>To be combined with the plate MONOKEY® K553N, or with the plate MONOLOCK® MKN</i>	
HONDA VFR 750 F (94 > 97)		
 K2420	Specific rear rack for MONOKEY ® or MONOLOCK ® top case <i>To be combined with the plate MONOKEY® K553N, or with the plate MONOLOCK® MKN</i>	
HONDA VT 750 S (10 > 14)		
 AS122A2	Specific fitting kit for A35 and A23	
 TK223	Specific holder for soft side bags <i>Chromed</i>	
HONDA VT Shadow 750 (04 > 14)		
 TK216	Specific holder for soft side bags <i>Chromed</i>	
 A41N	Universal screen, 53,7 x 51,6 cm (H x W) <i>to be combined with the specific AS121A2 fitting kit/ High and shaded bottom version</i>	
23A	Universal screen, 38,8 x 41 cm (H x W) <i>to be combined with the specific AS121A2 fitting kit</i>	
AS121A2	Specific fitting kit for 23A and A41N	
HONDA VT Shadow Spirit 750 (07 > 09)		
 A35N	Universal screen, 54,9 x 46,8 cm (H x W) <i>to be combined with the specific AS100A2 fitting kit</i>	
23A	Universal screen, 38,8 x 41 cm (H x W) <i>to be combined with the specific AS100A2 fitting kit</i>	
AS100A2	Specific fitting kit for 23A and A35N	
HONDA Crossrunner 800 (11 > 14)		
 KZ1104	Specific rear rack for MONOKEY ® or MONOLOCK ® top case <i>to be combined with the MONOKEY® KM5 or KM7 plates, or with the MONOLOCK® KM5M or KM6M plates</i>	
 KLXR1104	Specific rapid release side case holder for K33 MONOKEY ® SIDE cases <i>you must move the indicators from their original position</i>	
KLX1104	Specific pannier holder for K33 MONOKEY ® SIDE cases <i>it can be mounted without the specific rear rack KZ1104 using the 1104KIT / you must move the indicators from their original position</i>	
1104KIT	Specific kit to install the KLX1104 without the specific rear rack	

MOTORCYCLE ACCESSORIES

CODE	DESCRIPTION	PRICE
 1104DT	Specific screen, transparent 43,5 x 48 cm (H x W) <i>to be combined with the specific D1104KIT fitting kit/ 12 cm higher than original</i>	
D1104KIT	Specific fitting kit for 1104DT	
HONDA VFR 800 (98 > 01)		
 KZ257	Specific rear rack for MONOKEY ® or MONOLOCK ® top case <i>to be combined with the MONOKEY® KM5 or KM7 plates, or with the MONOLOCK® KM5M or KM6M plates / you must remove the grab rails, these are reproduced by the rack itself</i>	
 KL257	Specific pannier holder for MONOKEY ® side cases <i>it can be mounted only with the specific rear rack KZ257</i>	
HONDA VFR 800 VTEC (02 > 11)		
 KZ166	Specific rear rack for MONOKEY ® or MONOLOCK ® top case <i>to be combined with the MONOKEY® KM5 or KM7 plates, or with the MONOLOCK® KM5M or KM6M plates / it is not compatible with the original side-case holder</i>	
 KL166	Specific pannier holder for MONOKEY ® side cases	
KLXR166	Specific rapid release side case holder for K33 MONOKEY ® SIDE cases	
KLX166	Specific pannier holder for K33 MONOKEY ® SIDE cases	
 BF03K	Specific flange for fitting the tank bags with Tanklock system	
HONDA VFR 800 F (14) NEW		
 KZ1132	Specific rear rack for MONOKEY ® or MONOLOCK ® top case <i>to be combined with the MONOKEY® KM5 or KM7 plates, or with the MONOLOCK® KM5M or KM6M plates / maximum load allowed 6 kg</i>	
 KLXR1132	Specific rapid release side case holder for K33 MONOKEY ® SIDE cases <i>it can be mounted without the specific rear rack 1132FZ using the 1132KIT</i>	
1132KIT	Specific kit to install the KLXR1132 without the specific rear rack KZ1132	
 BF20K	Specific flange for fitting the tank bags with Tanklock system	
 KD1132S	Specific screen, smoked 48,2 x 36,5 cm (H x W) <i>to be mounted instead of the original screen / 8 cm higher than the original</i>	
VARIOUS ACCESSORIES 01SKIT	Specific kit to mounting the KS900A Smart Bar	
HONDA CB 900 Hornet (02 > 07)		
 KZ256	Specific rear rack for MONOKEY ® or MONOLOCK ® top case <i>to be combined with the MONOKEY® KM5 or KM7 plates, or with the MONOLOCK® KM5M or KM6M plates / Bronze colour</i>	
 KL256	Specific pannier holder for MONOKEY ® side cases <i>it can be mounted only with the specific rear rack KZ256</i>	
 240AK	Universal screen, smoked 33 x 36,5 cm <i>to be combined with the specific A257A fitting kit</i>	
HONDA CB 1000 R (08 > 14)		
 KZ266	Specific rear rack for MONOKEY ® or MONOLOCK ® top case <i>to be combined with the MONOKEY® KM5 or KM7 plates, or with the MONOLOCK® KM5M or KM6M plates</i>	
 TE1101K	Specific holder for soft side bags <i>it can be mounted without the specific rear rack KZ266 using the 1101KIT</i>	
1101KIT	Specific kit to install the TE1101K without the specific rear rack	
 BF03K	Specific flange for fitting the tank bags with Tanklock system	
 247A	↘ Universal screen, smoked 29 x 28,5 cm (H x W) <i>to be combined with the specific A1101A fitting kit / from year 2001</i>	
247N	Specific screen, black 29 x 28,5 cm (H x W) <i>to be combined with the specific A1101A fitting kit</i>	
A1101A	Specific fitting kit for 247A and 247N	
VARIOUS ACCESSORIES 04SKIT	Specific kit to mounting the KS900A Smart Bar	

THE INSIDE IS PAINTED IN MATT COLOUR TO PREVENT THE FRONT LIGHT FROM REFLECTING



↘ = Item available until it runs out of stock

CODE	DESCRIPTION	PRICE
HONDA CBF 1000 / ABS (06 > 09)		
KZ260	Specific rear rack for MONOKEY ® or MONOLOCK ® top case <i>to be combined with the MONOKEY® KMS or KM7 plates, or with the MONOLOCK® KMSM or KM6M plates / It is not compatible with the original side-case holder</i>	
KL174	Specific pannier holder for MONOKEY ® side cases	
KLXR174	Specific rapid release side case holder for K33 MONOKEY ® SIDE cases	
KLX174	Specific pannier holder for K33 MONOKEY ® SIDE cases <i>it can be mounted without the specific rear rack KZ260 using the PLX174KIT</i>	
PLX174KIT	Specific kit to install the KLX without the rack for the top case	
TK218	Specific holder for soft side bags	
BF03K	Specific flange for fitting the tank bags with Tanklock system	
KD303ST	Specific screen, transparent 54 x 39,5 cm (H x W) <i>to be mounted instead of the original screen / 12,5 cm higher than original / only for CBF 600 S</i>	
KN452	Specific engine guard <i>we recommend fitting by a qualified mechanic</i>	
HONDA CBF 1000 / CBF 1000 ST (10 > 14)		
KR777	Specific rear rack for MONOKEY ® top case MONOKEY ® plate included / you must remove the grabrails, they are reproduced by the rack itself / is compatible with the original side case holder	
KR777M	Specific rear rack for MONOLOCK ® top case MONOLOCK ® plate included / you must remove the grabrails, they are reproduced by the rack itself / is compatible with the original side case holder	
KL208	Specific pannier holder for MONOKEY ® side cases	
KLXR208	Specific rapid release side case holder for K33 MONOKEY ® SIDE cases <i>it can be mounted only with the specific rear rack KR777 / KR777M or 777KIT</i>	
777KIT	Specific kit to install the KLXR and the KL without the KLate	
BF03K	Specific flange for fitting the tank bags with Tanklock system	
KD320ST	Specific screen, transparent 49 x 42,5 cm (H x W) <i>15 cm higher than the original / adjustable as the original</i>	
KN460	Specific engine guard <i>we recommend fitting by a qualified mechanic</i>	
VARIOUS ACCESSORIES 02SKIT	Specific kit to mounting the KS900A Smart Bar	
HONDA CBR 1000 F (89 > 92)		
K2270	Specific rear rack for MONOKEY ® or MONOLOCK ® top case <i>To be combined with the plate MONOKEY® K553N, or with the plate MONOLOCK® MKN</i>	
K8155	Specific wingrack fitting kit <i>It can be combined only with the chassis K141</i>	
HONDA CBR 1000 F (93 > 00)		
K2270	Specific rear rack for MONOKEY ® or MONOLOCK ® top case <i>To be combined with the plate MONOKEY® K553N, or with the plate MONOLOCK® MKN</i>	
K8155	Specific wingrack fitting kit <i>It can be combined only with the chassis K141</i>	
HONDA CBR 1000 RR (06 > 07)		
D308SP	Protective deflector <i>It must be installed on the original spoiler to increase the protection.</i>	
HONDA CBR 1000 RR (08 > 09)		
TKB01	↘ Specific "Tanky" base for Honda CBR1000RR (08 > 10), compatible with the tank bag TKB740.	
BF03K	Specific flange for fitting the tank bags with Tanklock system	

MOTORCYCLE ACCESSORIES

CODE	DESCRIPTION	PRICE
HONDA CBR 1000 RR (12 > 13)		
 BF03K	Specific flange for fitting the tank bags with Tanklock system	
HONDA VTR 1000 F (97 > 04)		
 K2510	Specific rear rack for MONOKEY ® or MONOLOCK ® top case <i>To be combined with the plate MONOKEY® K553N, or with the plate MONOLOCK® MKN</i>	
HONDA XL 1000V Varadero (99 > 02)		
 K212	Specific rear rack for MONOKEY ® top case MONOKEY ® plate included	
 KL164	Specific pannier holder for MONOKEY ® side cases	
 KD203S	Specific screen, smoked 62,4 x 55 cm (H x W)	
KD203ST	Specific screen, transparent 62,4 x 55 cm (H x W)	
 KN25	Specific engine guard <i>we recommend fitting by a qualified mechanic / black colour</i>	
HONDA XL 1000V Varadero / ABS (03 > 06)		
 K212	Specific rear rack for MONOKEY ® top case MONOKEY ® plate included	
 KL170	Specific pannier holder for MONOKEY ® side cases	
 KD300ST	Specific screen, transparent 60 x 48 cm (H x W) <i>9 cm higher than the original</i>	
KD300S	Specific screen, smoked 60 x 48 cm (H x W) <i>9 cm higher than the original</i>	
 KN28	Specific engine guard <i>we recommend fitting by a qualified mechanic / colour black.</i>	
HONDA XL 1000V Varadero / ABS (07 > 12)		
 K222	Specific rear rack for MONOKEY ® top case MONOKEY ® plate included	
 KL177	Specific pannier holder for MONOKEY ® side cases	
KLX177	Specific pannier holder for K33 MONOKEY ® SIDE cases	
 KD300S	Specific screen, smoked 60 x 48 cm (H x W) <i>9 cm higher than the original</i>	
KD300ST	Specific screen, transparent 60 x 48 cm (H x W) <i>9 cm higher than the original</i>	
 KN454	Specific engine guard <i>we recommend fitting by a qualified mechanic</i>	
HONDA CB 1100 (13)		
 KR1118	Specific rear chromed rack for MONOLOCK ® or MONOKEY ® top case <i>to be combined with the K636 MONOKEY® plate, or with the plate already included in the MONOLOCK® top cases</i>	
HONDA CBR 1100 XX (97 > 09)		
 K2480	Specific rear rack for MONOKEY ® or MONOLOCK ® top case <i>To be combined with the plate MONOKEY® K553N, or with the plate MONOLOCK® MKN</i>	
 K8158	Specific wingrack fitting kit <i>It can be combined only with the chassis K140</i>	
 KD196H	↘ Specific screen, smoked 42,6 x 62 cm (H x W)	
HONDA ST 1100 Pan European		
 K109	Specific rear rack for MONOLOCK ® top case MONOKEY ® plate included	



↘ = Item available until it runs out of stock



CODE	DESCRIPTION	PRICE
HONDA Crosstourer 1200 (12 > 14)		
KR1110	Specific rear rack for MONOKEY ® top case <i>maximum load allowed 6 kg / MONOKEY® plate included</i>	
KRA1110	Specific rear rack in aluminium for MONOKEY ® top case <i>maximum load allowed 6kg / it does not allow the assembly of the stop light kit or the remote control device on the case / to be mounted on the original case carrier</i>	
KLR1110	Specific rapid release side case holder for MONOKEY ® cases	
KLXR1110	Specific rapid release side case holder for K33 MONOKEY ® SIDE cases	
BF03K	Specific flange for fitting the tank bags with Tanklock system <i>compatible from 12 to 13</i>	
BF20K	Specific flange for fitting the tank bags with Tanklock system <i>from 2014 onwards</i>	
KD1110ST	Specific screen, transparent 51 x 42 cm (H x W) <i>19 cm higher than the original wind-screen</i>	
EH1110K	Plexiglass extension for original hand protectors, smoked	
KAF1110	Specific Airstream sliding wind-screen transparent. <i>complete with specific fitting kit</i>	
KN1110	Specific engine guard <i>we recommend fitting by a qualified mechanic</i>	
KN11100X	Specific engine guard, stainless steel <i>we recommend fitting by a qualified mechanic / stainless steel</i>	
RP1110	Oil carter protector in Aluminium <i>it is not compatible with versions equipped with automatic gears</i>	
VARIOUS ACCESSORIES ES1110K	Specific support in aluminum and stainless steel to widen the surface support area of the original side stand	
03SKIT	Specific kit to mounting the KS900A Smart Bar	

HONDA VFR 1200 F (10 > 14)		
KZ267	Specific rear rack for MONOKEY ® or MONOLOCK ® top case <i>to be combined with the MONOKEY® KM5 or KM7 plates, or with the MONOLOCK® KM5M or KM6M plates/ in order to fit it you must remove the handle bar of the scooter / it is compatible with the original side case holder</i>	
KLX209	Specific pannier holder for K33 MONOKEY ® SIDE cases <i>it can be mounted without the specific rear rack KZ267 using the 267KIT</i>	
267KIT	↘ Specific kit to install the KLX without the specific rear rack	
TKB05	↘ Specific "Tanky" base compatible with the tank bags TKB748 - TKB751	
BF03K	Specific flange for fitting the tank bags with Tanklock system	
KD321S	↘ Specific screen, smoked 40 x 40 cm (H x W) <i>14 cm higher than original</i>	



HONDA CB 1300 / CB 1300 S (03 > 09)		
KZ259	Specific rear rack for MONOKEY ® or MONOLOCK ® top case <i>to be combined with the MONOKEY® KM5 or KM7 plates, or with the MONOLOCK® KM5M or KM6M plates</i>	
KN451	Specific engine guard <i>we recommend fitting by a qualified mechanic</i>	





HONDA CB 1300 S (10 > 14)		
KZ268	Specific rear rack for MONOKEY ® or MONOLOCK ® top case <i>to be combined with the MONOKEY® KM5 or KM7 plates, or with the MONOLOCK® KM5M or KM6M plates</i>	
BF03K	Specific flange for fitting the tank bags with Tanklock system	
TE224K	↘ Specific holder for soft side bags	
KD324S	Specific screen, smoked 56 x 36 cm (H x W) <i>to be mounted instead of the original screen / 20,5 cm higher than original</i>	
KN451	Specific engine guard <i>we recommend fitting by a qualified mechanic</i>	



MOTORCYCLE ACCESSORIES

CODE	DESCRIPTION	PRICE
HONDA	CTX 1300 (14) NEW	
 KR1134	Specific rear rack for MONOKEY ® top case to be combined with the plate already included in the MONOKEY ® top case	
 KD1134ST	Specific screen, transparent, transparent, 51,5 x 65 cm (h x w) to be mounted instead of the original screen	

KAWASAKI





KAWASAKI	Ninja 250 R (08 > 12)	
 KZ4107	Specific rear rack for MONOKEY ® or MONOLOCK ® top case to be combined with the MONOKEY ® KM5 or KM7 plates, or with the MONOLOCK ® KM5M or KM6M plates / maximum load allowed 6 kg	
 TE4107K	Specific holder for soft side bags it can be mounted without the specific rear rack KZ4107 using the 4107KIT	
4107KIT	Specific kit to install the TE4107K without the specific rear rack KZ4107	
 KD4107S	Specific screen, smoked 46 x 31 cm (H x W) to be mounted instead of the original screen / 12 cm higher than original	

KAWASAKI	Ninja 300 (13 > 14)	
 KZ4108	Specific rear rack for MONOKEY ® or MONOLOCK ® top case to be combined with the MONOKEY ® KM5 or KM7 plates, or with the MONOLOCK ® KM5M or KM6M plates / maximum load allowed 6 kg	
 TE4108K	Specific holder for soft side bags it can be mounted without the specific rear rack 4108FZ using the 4108KIT	
4108KIT	Specific kit to install the TE4108K without the specific rear rack KZ4108	
 BF14K	Specific flange for fitting the tank bags with Tanklock system	
 KD4108S	Specific screen, smoked 42 x 34 cm (H x W) to be mounted instead of the original screen / 9 cm higher than original	

KAWASAKI	J300 (14) NEW	
 KR4111	Specific rear rack for MONOKEY ® top case MONOKEY ® plate included	
KR4111MM	Specific rear rack for MONOLOCK ® top case MONOLOCK ® plate with place for the "u" type padlock included	
 4111DT	Specific screen, transparent 79,5 x 65 cm (H x W) to be combined with the specific D4111KIT fitting kit / 23 cm higher than the original	
D4111KIT	Specific fitting kit for 4111DT	
VARIOUS ACCESSORIES	KTB4111	Specific backrest it cannot be mounted if rack and case are installed

KAWASAKI	ER 5 500 (98 > 00)	
 K4320	Specific rear rack for MONOKEY ® or MONOLOCK ® top case To be combined with the plate MONOKEY ® K553N, or with the plate MONOLOCK ® MKN	

KAWASAKI	ER 5 500 (01 > 07)	
 K4400	Specific rear rack for MONOKEY ® or MONOLOCK ® top case To be combined with the plate MONOKEY ® K553N, or with the plate MONOLOCK ® MKN	

KAWASAKI	ER 6N / ER 6F 650 (05 > 08)	
 KZ445	Specific rear rack for MONOLOCK ® top case maximum load allowed 6 kg / to be combined with the MONOLOCK ® KM5M or KM6M plates	
 KLX445	Specific pannier holder for K33 MONOKEY ® SIDE cases it can be mounted only with the specific rear rack KZ445 / you must move the indicators from their original position	
 TK262	Specific holder for soft side bags	
 BF04K	Specific flange for fitting the tank bags with Tanklock system	
 246N902K	Universal screen, smoked 38 x 33,5 cm (H x W) to be combined with the specific A445A fitting kit / With black bottom frame / only for ER-6N	
245N	Universal screen, black 33,5 x 29 cm (H x W) to be combined with the specific A445A fitting kit / only for ER-6N	



↘ = Item available until it runs out of stock

CODE	DESCRIPTION	PRICE
A445A	Specific fitting kit for 245N and 246N902K only for ER-6N	
KAWASAKI ER-6N / ER-6F 650 (09 > 11)		
KZ449	Specific rear rack for MONOKEY ® or MONOLOCK ® top case to be combined with the MONOKEY ® KMS or KM7 plates, or with the MONOLOCK ® KMSM or KM6M plates / you need to remove the handle bar of the scooter to install it	
KLX449	Specific pannier holder for K33 MONOKEY ® SIDE cases it can be mounted without the specific rear rack KZ449 using the PLX449KIT / you must remove the original grabrails	
PLX449KIT	Specific kit to install the KLX without the rack for the top case	
TE266K	Telaietti specifici per borse soffici laterali	
BF04K	Specific flange for fitting the tank bags with Tanklock system	
247N	Specific screen, black 29 x 28,5 cm (H x W) to be combined with the specific A448A fitting kit	
A448A	Specific fitting kit for 247N only for ER-6N models	
KD409S	Specific screen, smoked 44 x 35 cm (H x W) 6 cm higher than original / made only for ER-6F	
VARIOUS ACCESSORIES 03SKIT	Specific kit to mounting the KS900A Smart Bar	

THE INSIDE IS PAINTED IN MATT COLOUR TO PREVENT THE FRONT LIGHT FROM REFLECTING



KAWASAKI ER-6N / ER-6F 650 (12 > 14)		
KZ4104	Specific rear rack for MONOKEY ® or MONOLOCK ® top case to be combined with the MONOKEY ® KMS or KM7 plates, or with the MONOLOCK ® KMSM or KM6M plates / black colour	
KLX4104	Specific pannier holder for K33 MONOKEY ® SIDE cases	
TE4104K	Specific holder for soft side bags	
BF04K	Specific flange for fitting the tank bags with Tanklock system	
KA4104	Specific screen, smoked 32 x 30 cm (H x W) Complete with fitting kit	
KD4104S	Specific screen, transparent smoked (H x W) 50 x 40 cm 10 cm higher than original / only for ER-6F	
VARIOUS ACCESSORIES 03SKIT	Specific kit to mounting the KS900A Smart Bar only for version ER-6F	







KAWASAKI ZZR 600 (93 > 01)		
K4230	Specific rear rack for MONOKEY ® or MONOLOCK ® top case To be combined with the plate MONOKEY ® K553N, or with the plate MONOLOCK ® MKN	

KAWASAKI ZX-6R (09 > 12)		
BF04K	Specific flange for fitting the tank bags with Tanklock system	



KAWASAKI KLR 650 Enduro (07 > 14)		
K581	Specific rear rack for MONOKEY ® top case MONOKEY ® plate included	
KE5810	Specific rear rack for MONOLOCK ® top case to be combined with the plate already included in the MONOLOCK ® top case	
KL448	Specific pannier holder for MONOKEY ® side cases	
408D	Specific screen, smoked 54 x 35 cm (H x W) to be combined with the specific D408KIT fitting kit/ 23 cm higher than original	
D408KIT	Specific fitting kit for 408D	
KN421	Specific engine guard we recommend fitting by a qualified mechanic.	





MOTORCYCLE ACCESSORIES

CODE	DESCRIPTION	PRICE
KAWASAKI Versys 650 (06 > 09)		
 KZ447	Specific rear rack for MONOKEY ® or MONOLOCK ® top case to be combined with the MONOKEY ® KM5 or KM7 plates, or with the MONOLOCK ® KM5M or KM6M plates / black colour / fitting kit included	
 KLX447	↘ Specific pannier holder for K33 MONOKEY ® SIDE cases it can be mounted without the specific rear rack KZ447 using the PLX447KIT / you must move the indicators from their original position	
KL447	Specific pannier holder for MONOKEY ® side cases it can be mounted without the specific rear rack KZ447 using the PLX447KIT / the indicators must be moved from original position	
PLX447KIT	Specific kit to install the KLX without the rack for the top case	
 KD405ST	Specific screen, transparent 46 x 44,5 cm (H x W) 18 cm higher than the original	
VARIOUS ACCESSORIES KMG4103	Mudguard/specific ABS chain-cover, black colour	

KAWASAKI Versys 650 (10 > 14)		
 KZ451	Specific rear rack for MONOKEY ® or MONOLOCK ® top case to be combined with the MONOKEY ® KM5 or KM7 plates, or with the MONOLOCK ® KM5M or KM6M plates	
 KLR450	Specific rapid release side case holder for MONOKEY ® cases it can be mounted without the specific rear rack KZ451 using the 450KIT / you must move the indicators from their original position	
KLXR450	Specific rapid release side case holder for K33 MONOKEY ® SIDE cases can be mounted without the the specific rear rack using the 450KIT / you must move the indicators from their original position	
450KIT	Specific kit to install the KLR450 and the KLXR450 without the specific rear rack KZ451	
 TE4103K	Specific holder for soft side bags	
 BF04K	Specific flange for fitting the tank bags with Tanklock system	
 KD410ST	Specific screen, transparent 48 x 37 cm (H x W) 21 cm higher than the original	
 KN422	Specific engine guard we recommend fitting by a qualified mechanic	
VARIOUS ACCESSORIES ES4103K	Specific support in aluminum and stainless steel to widen the surface support area of the original side stand	
KMG4103	Mudguard/specific ABS chain-cover, black colour	
03SKIT	Specific kit to mounting the KS900A Smart Bar	
KHP4103	Hand protector specific ABS	

KAWASAKI ZR 7 / ZR 7 S 750 (99 > 04)		
 K4360	Specific rear rack for MONOKEY ® or MONOLOCK ® top case To be combined with the plate MONOKEY ® KS53N, or with the plate MONOLOCK ® MKN	

KAWASAKI Z 750 (04 > 06)		
 KZ443	Specific rear rack for MONOKEY ® or MONOLOCK ® top case to be combined with the MONOKEY ® KM5 or KM7 plates, or with the MONOLOCK ® KM5M or KM6M plates / maximum load allowed 6 kg	
 BF04K	Specific flange for fitting the tank bags with Tanklock system	
 D402KIT	Specific fitting kit for 402D	

KAWASAKI Z 750 (07 > 13)		
 KZ448	Specific rear rack for MONOKEY ® or MONOLOCK ® top case to be combined with the MONOKEY ® KM5 or KM7 plates, or with the MONOLOCK ® KM5M or KM6M plates / maximum load allowed 6 kg / in order to install it you must reposition the indicators from their original position	
 TE265K	Specific holder for soft side bags it can be mounted without the specific rear rack KZ448 using the T265KIT / you must move the indicators from their original position	
 BF04K	Specific flange for fitting the tank bags with Tanklock system	
 KA446	Specific screen, smoked 34 x 34 cm (H x W) Complete with fitting kit	



















KAWASAKI Z 750 S (05 > 07)		
 KZ444	Specific rear rack for MONOKEY ® or MONOLOCK ® top case to be combined with the MONOKEY ® KM5 or KM7 plates, or with the MONOLOCK ® KM5M or KM6M plates / maximum load allowed 6 kg	



↘ = Item available until it runs out of stock





CODE	DESCRIPTION	PRICE
KAWASAKI Z800 (13 > 14)		
KZ4109	Specific rear rack for MONOKEY ® or MONOLOCK ® top case <i>to be combined with the MONOKEY® KMS or KM7 plates, or with the MONOLOCK® KMSM or KM6M plates / maximum load allowed 6 kg</i>	
TE4109K	Specific holder for soft side bags <i>it can be mounted without the specific rear rack KZ4109 using the 4109KIT</i>	
4109KIT	Specific kit to install the TE4109K without the specific rear rack KZ109	
BF04K	Specific flange for fitting the tank bags with Tanklock system	
KA4109	Specific screen, smoked 28 x 38 cm (H x W) <i>Complete with fitting kit</i>	
VARIOUS ACCESSORIES 02SKIT	Specific kit to mounting the KS900A Smart Bar	
KAWASAKI W 800 (11 > 14)		
KR4101	Specific rear rack for MONOLOCK ® or MONOKEY ® top case <i>to be combined with the K636 MONOKEY® plate, or with the plate already included in the MONOLOCK® top cases</i>	
KL4101	Specific pannier holder for MONOKEY ® side cases	
KA4101	Specific screen, smoked 37 x 33,5 cm (H x W) <i>including fixing kit</i>	
KN4101	Specific engine guard <i>we recommend fitting by a qualified mechanic</i>	
VARIOUS ACCESSORIES 02SKIT	Specific kit to mounting the KS900A Smart Bar	
KAWASAKI VN 900 Custom / Classic (06 > 14)		
KL4102	Specific pannier holder for MONOKEY ® side cases	
TK264	Specific holder for soft side bags <i>Chromed</i>	
A37N	Specific screen, transparent 54 x 47,2 cm (H x W) <i>high and shaded bottom version / only for Classic version</i>	
AS128A2	Specific chromed rack for screen A36 and A37N <i>only for Classic version</i>	
23A	Specific screen, transparent 38,8 x 41 cm (H x W) <i>low, transparent version / only for Custom version</i>	
A35N	specific screen, transparent 54,9 x 46,8 cm (H x W) <i>high and shaded bottom version / only for Custom version</i>	
AS100A2	Specific chromed rack for screen 23A and A35N <i>only for Custom version</i>	
KAWASAKI GTR 1000		
K28	Specific rear rack for MONOKEY ® top case MONOKEY ® plate included	
KAWASAKI KLV 1000 (04 > 09)		
K528M	Specific rear rack for MONOLOCK ® top case <i>to be combined with the plate already included in the MONOLOCK® top case</i>	
KL528	Specific pannier holder for MONOKEY ® side cases	
KLX528	Specific pannier holder for K33 MONOKEY ® SIDE cases	
KD260ST	Specific screen, transparent 57 x 48 cm (H x W) <i>compatible with models '04 / 18 cm higher than original / only with spoiler</i>	
KAF260	Specific Airstream sliding wind-screen, transparent, complete with fitting kit. Maximum height 65 cm (12 cm of extension) width 44 cm <i>to be mounted instead of the original screen</i>	
KN46	Specific engine guard <i>we recommend fitting by a qualified mechanic</i>	

MOTORCYCLE ACCESSORIES

CODE	DESCRIPTION	PRICE
KAWASAKI Versys 1000 (12 > 14)		
 KR4105	Specific rear rack for MONOKEY ® top case MONOKEY ® plate included	
KR4105M	Specific rear rack for MONOLOCK ® top case <i>to be combined with the plate already included in the MONOLOCK® top case</i>	
KRA4105	Specific rear rack in aluminium for MONOKEY ® top case <i>maximum load allowed 6kg / it does not allow the assembly of the stop light kit or the remote control device on the case</i>	
 KLR4105	Specific rapid release side case holder for MONOKEY ® cases <i>you must move the indicators from their original position</i>	
KLXR4105	Specific rapid release side case holder for K33 MONOKEY ® SIDE cases	
 BF04K	Specific flange for fitting the tank bags with Tanklock system	
 KD4105ST	Specific screen, transparent 49 x 48 cm (H x W) <i>16 cm higher than the original</i>	
KAF4105	Specific Airstream sliding wind-screen transparent. Maximum height 52 cm (12 cm of extension), width 48 cm <i>complete with specific fitting kit / to be mounted instead of the original screen</i>	
 KN4105	Specific engine guard, chromed <i>we recommend fitting by a qualified mechanic</i>	
VARIOUS ACCESSORIES ES4105K	Specific support in aluminum and stainless steel to widen the surface support area of the original side stand	
025KIT	Specific kit to mounting the KS900A Smart Bar	
KAWASAKI Z 1000 (03 > 06)		
 KZ442	Specific rear rack for MONOKEY ® or MONOLOCK ® top case <i>to be combined with the MONOKEY® KM5 or KM7 plates, or with the MONOLOCK® KM5M or KM6M plates / maximum load allowed 6 kg</i>	
 KD401S	Specific screen, smoked 41 x 26,5 cm (H x W)	
KAWASAKI Z 1000 (07 > 09)		
 KZ448	Specific rear rack for MONOKEY ® or MONOLOCK ® top case <i>to be combined with the MONOKEY® KM5 or KM7 plates, or with the MONOLOCK® KM5M or KM6M plates / maximum load allowed 6 kg / in order to install it you must reposition the indicators from their original position</i>	
 KA447	Specific screen, smoked cm 34 x 34 cm (H x W) <i>Complete with fitting kit</i>	
 TE265K	Specific holder for soft side bags <i>it can be mounted without the specific rear rack KZ448 using the T265KIT / you must move the indicators from their original position</i>	
KAWASAKI Z 1000 (10 > 13)		
 KZ450	Specific rear rack for MONOKEY ® or MONOLOCK ® top case <i>to be combined with the MONOKEY® KM5 or KM7 plates, or with the MONOLOCK® KM5M or KM6M plates / maximum load allowed 6 kg</i>	
 TK267	Specific holder for soft side bags <i>it can be mounted without the specific rear rack KZ450 using the T267KIT</i>	
T267KIT	Specific fitting kit for tubular holder	
 BF04K	Specific flange for fitting the tank bags with Tanklock system	
 KA449	↘ Specific screen, smoked 42 x 36 cm (H x W) <i>Complete with fitting kit</i>	
KAWASAKI Z 1000 SX (11 > 14)		
 KZ4100	Specific rear rack for MONOKEY ® or MONOLOCK ® top case <i>to be combined with the MONOKEY® KM5 or KM7 plates, or with the MONOLOCK® KM5M or KM6M plates / it is not compatible with the original sidecase holder</i>	
 KLXR4100	Specific rapid release side case holder for K33 MONOKEY ® SIDE cases <i>it can be mounted without the specific rear rack KZ4100 using the 4100KIT</i>	
4100KIT	Specific kit to install the KLXR4100 without the specific rear rack KZ4100	
 TE4100K	Specific holder for soft side bags	
 4100D	↘ Specific screen, smoked 56 x 37 cm (H x W) <i>to be combined with the specific D4100KIT fitting kit / 14 cm higher than the original</i>	
D4100KIT	↘ Specific fitting kit for 4100D	



↘ = Item available until it runs out of stock

CODE	DESCRIPTION	PRICE
 BF04K	Specific flange for fitting the tank bags with Tanklock system <i>only for years from 2010 to 2013</i>	
KAWASAKI ZRX 1100 / ZRX 1100 S (97 > 01)		
 K4330	Specific rear rack for MONOKEY ® or MONOLOCK ® top case <i>To be combined with the plate MONOKEY® K553N, or with the plate MONOLOCK® MKN / maximum load allowed 6 kg</i>	
 KD174S	Specific screen, smoked 36,2 x 32,1 cm (H x W) <i>Made only for faired version / to be mounted instead of the original screen</i>	
KAWASAKI ZZR 1100 (93 > 01)		
 K4220	Specific rear rack for MONOKEY ® or MONOLOCK ® top case <i>To be combined with the plate MONOKEY® K553N, or with the plate MONOLOCK® MKN</i>	
KAWASAKI ZZR 1200 (02 > 05)		
 KZ441	Specific rear rack for MONOKEY ® or MONOLOCK ® top case <i>to be combined with the MONOKEY® KM5 or KM7 plates, or with the MONOLOCK® KM5M or KM6M plates / you must remove the original grab handles, these are reproduced by the rack itself</i>	
 KL441	Specific pannier holder for MONOKEY ® side cases <i>it can be mounted only with the specific rear rack KZ441</i>	
KAWASAKI ZRX 1200 (02)		
 K4330	Specific rear rack for MONOKEY ® or MONOLOCK ® top case <i>To be combined with the plate MONOKEY® K553N, or with the plate MONOLOCK® MKN / maximum load allowed 6 kg</i>	
KAWASAKI ZRX 1200 R (02)		
 K4330	Specific rear rack for MONOKEY ® or MONOLOCK ® top case <i>To be combined with the plate MONOKEY® K553N, or with the plate MONOLOCK® MKN / maximum load allowed 6 kg</i>	
 KD174S	Specific screen, smoked 36,2 x 32,1 cm (H x W) <i>Made only for faired version / to be mounted instead of the original screen</i>	
KAWASAKI ZRX 1200 S (01 > 02)		
 K4330	Specific rear rack for MONOKEY ® or MONOLOCK ® top case <i>To be combined with the plate MONOKEY® K553N, or with the plate MONOLOCK® MKN / maximum load allowed 6 kg</i>	
KAWASAKI ZX 10 R (10 > 12)		
 BF04K	Specific flange for fitting the tank bags with Tanklock system	
KAWASAKI GTR 1400 (07 > 14)		
 KR410	Specific rear rack for MONOKEY ® top case MONOKEY ® plate included	
 KD407ST	↘ Specific screen, transparent 58 x 53 cm (H x W) <i>8,5 cm higher than the original (07 > 09) / 2,5 cm higher than original (10)</i>	
KAWASAKI ZZR 1400 / ZX 14 (06 > 11)		
 KLX446	Specific pannier holder for K33 MONOKEY ® SIDE cases	
KAWASAKI ZZR 1400 (12 > 14)		
 KZ4106	Specific rear rack for MONOKEY ® or MONOLOCK ® top case <i>to be combined with the MONOKEY® KM5 or KM7 plates, or with the MONOLOCK® KM5M or KM6M plates</i>	
 TE4106K	Specific holder for soft side bags	
 KD4106S	↘ Specific screen, smoked colour (H x W) 42 cm x 36 cm	



MOTORCYCLE ACCESSORIES

CODE	DESCRIPTION	PRICE
KEEWAY		
KEEWAY Goccia 50 (09 > 11)		
 KE8510	Specific rear rack for MONOLOCK ® top case <i>to be combined with the plate already included in the MONOLOCK® top case</i>	
 107A	Specific screen, transparent 50,8 x 66 cm (H x W) <i>to be combined with the specific A851A fitting kit</i>	
KEEWAY RY6 50 (10 > 11)		
 KR852	Specific rear rack for MONOLOCK ® top case <i>to be combined with the plate already included in the MONOLOCK® top case</i>	
 288A	Specific screen, transparent 56 x 71,5 cm (H x W) <i>to be combined with the specific A853A fitting kit</i>	
A853A	Specific fitting kit for 288A	
KEEWAY RY8 50 Evo Sport (10 > 11)		
 KR852	Specific rear rack for MONOLOCK ® top case <i>to be combined with the plate already included in the MONOLOCK® top case</i>	
 288A	Specific screen, transparent 56 x 71,5 cm (H x W) <i>to be combined with the specific A852A fitting kit</i>	
A852A	Specific fitting kit for 288A	
KEEWAY Logik 125-150 (13 > 14)		
 308A	Specific screen, transparent with serigraphy 52 x 66,5 cm (H x W) <i>to be combined with the specific A9100A fitting kit</i>	
A9100A	Specific fitting kit for 308A	
KEEWAY Outlook 125-150 (09)		
 120A	Specific screen, transparent 66 x 67 cm (H x W) <i>to be combined with the specific A850A fitting kit</i>	
121A	Specific screen, transparent 74 x 67 cm (H x W) <i>to be combined with the specific A850A fitting kit/ 8 cm higher than 120A</i>	
A850A	Specific fitting kit for 120A and 121A	
KTM		
KTM DUKE 125-200-390 (11 > 14)		
 KR7701	Specific rear rack for MONOLOCK ® top case <i>to be combined with the plate already included in the MONOLOCK® top case</i>	
 BF12K	Specific flange for fitting the tank bags with Tanklock system	
 247A	Universal screen, smoked 29 x 28,5 cm (H x W) <i>to be combined with the specific A7701A fitting kit</i>	
247N	Specific screen, black 29 x 28,5 cm (H x W) <i>to be combined with the specific A7701A fitting kit</i>	
A7701A	Specific fitting kit for 247A and 247N	
VARIOUS ACCESSORIES 035KIT	Specific kit to mounting the KS900A Smart Bar	
KTM DUKE 690 (12 > 14)		
 KZ7702	Specific rear rack for MONOKEY ® or MONOLOCK ® top case <i>to be combined with the MONOKEY® KM5 or KM7 plates, or with the MONOLOCK® KMSM or KM6M plates</i>	
 TE7702K	Specific holder for soft side bags	
 245A	Universal screen, smoked 33,5 x 29 cm (H x W) <i>to be combined with the specific A7702A fitting kit</i>	









↘ = Item available until it runs out of stock

CODE	DESCRIPTION	PRICE
245N	Universal screen, black 33,5 x 29 cm (H x W) <i>to be combined with the specific A7702A fitting kit</i>	
A7702A	Specific fitting kit for 245A and 245N	
VARIOUS ACCESSORIES 01SKIT	Specific kit to mounting the KS900A Smart Bar	

KTM Adventure 950 / 990 (03 > 14)		
 KE6500	Specific rear rack for MONOLOCK ® top case <i>to be combined with the plate already included in the MONOLOCK® top case</i>	
KR7700	Specific rear rack for MONOKEY ® top case <i>maximum load allowed 6 kg / MONOKEY® plate included</i>	
 KL650	Specific pannier holder for MONOKEY ® side cases	
VARIOUS ACCESSORIES ES7703K	Specific support in aluminum and stainless steel to widen the surface support area of the original side stand <i>only for 2013</i>	
01SKIT	Specific kit to mounting the KS900A Smart Bar	

KTM Superduke 990 (08) NEW		
 BF02K	Specific flange for fitting the tank bags with Tanklock system	

KTM 990 SMT (09 > 14)		
 KRA750	Specific rear rack in aluminium for MONOKEY ® top case <i>maximum load allowed 6kg / it does not allow the assembly of the stop light kit or the remote control device on the case</i>	
 KLR750	Specific rapid release side case holder for MONOKEY ® cases	
VARIOUS ACCESSORIES 01SKIT	Specific kit to mounting the KS900A Smart Bar	

KTM 1190 Adventure / 1190 Adventure R (13 > 14) NEW		
 KR7703	Specific rear rack for MONOKEY ® top case MONOKEY ® plate included	
KRA7703	Specific rear rack in aluminium for MONOKEY ® top case <i>maximum load allowed 6kg / it does not allow the assembly of the stop light kit or the remote control device on the case</i>	
 KLR7703	Specific rapid release side case holder for MONOKEY ® cases	
 BF11K	Specific flange for fitting the tank bags with Tanklock system <i>only with tank bag with Tanklock system RA311</i>	
 KD7703ST	Specific screen, transparent 37 x 41 cm (H x W) <i>to be mounted instead of the original screen / 17 cm higher than original</i>	
KAF7703	Specific Airstream sliding wind-screen transparent. Maximum height 64 cm (12 cm of excursion) width 41 cm <i>complete with specific fitting kit / to be mounted instead of the original screen</i>	
 KN7703	Specific engine guard <i>we recommend fitting by a qualified mechanic / black colour / only for 1190 Adventure</i>	
RP7703	Oil carter protector in Aluminium	
VARIOUS ACCESSORIES ES7703K	Specific support in aluminum and stainless steel to widen the surface support area of the original side stand <i>only for 2013</i>	
ES7704K	Specific support in aluminum and stainless steel to widen the surface support area of the original side stand <i>only for 1190 Adventure / 1190 Adventure R (14)</i>	
01SKIT	Specific kit to mounting the KS900A Smart Bar	



KYMCO

KYMCO Agility 50-125-150-200 R16 (08 > 13)		
 KE1370	Specific rear rack for MONOLOCK ® top case <i>to be combined with the plate already included in the MONOLOCK® top case</i>	
 440A	Specific screen, transparent 66 x 64 cm (H x W) <i>to be combined with the specific A440A fitting kit</i>	

MOTORCYCLE ACCESSORIES

CODE	DESCRIPTION	PRICE
441A	Specific screen, transparent 72 x 66 cm (H x W) <i>to be combined with the specific A440A fitting kit/ 8 cm higher than 440A</i>	
A440A	Specific fitting kit for 440A and 441A	
105A	Specific screen, transparent 66 x 67 cm (H x W) <i>only available if article A439A is already fitted to be mounted instead of the original screen / to be combined with the specific A439A fitting kit</i>	
128A	Specific screen, transparent 74 x 67 cm (H x W) <i>/ only available if article A439A is already fitted to be combined with the specific A439A fitting kit/ 8 cm higher than 105A</i>	

KYMCO **Dink 50-125-200 i (06 > 14)**

 KR90	Specific rear rack for MONOLOCK ® top case <i>to be combined with the plate already included in the MONOLOCK® top case</i>
 292DT	Specific screen, transparent 67 x 58 cm (H x W) <i>to be combined with the specific D292KIT fitting kit/ 37 cm higher than the original</i>
D292KIT	Specific fitting kit for 292DT

KYMCO **Like 50-125-200i (09 > 14)**



 6102A	Specific screen, transparent 52 x 66,6 cm (H x W) <i>to be combined with the specific A6102A fitting kit</i>
A6102A	Specific fitting kit for 6102A

KYMCO **People S 50-125-200 (05 > 14)**



 137A	Specific screen, transparent 64 x 71 cm (H x W) <i>to be combined with the specific A137A fitting kit</i>
A137A	Specific fitting kit for 137A

You can fit a Monolock® top-case using the universal plate included.



KYMCO **Agility 125-200 R16+ (14) **NEW****

 KR6106	Specific rear rack for MONOLOCK ® top case <i>to be combined with the plate already included in the MONOLOCK® top case</i>
 440A	Specific screen, transparent 66 x 64 cm (H x W) <i>to be combined with the specific A6106A fitting kit</i>
441A	Specific screen, transparent 72 x 66 cm (H x W) <i>to be combined with the specific A6106A fitting kit / 6 cm higher than 440A</i>
A6106A	Specific fitting kit for 440A and 441A

KYMCO **Downtown 125i-200i-300i (09 > 14)**

 KR92	Specific rear rack for MONOKEY ® top case MONOKEY ® plate included / maximum load allowed 6 kg
KR920	Specific rear rack for MONOLOCK ® top case MONOLOCK ® plate included
 KD294ST	Specific screen, transparent 81,5 x 64 cm (H x W) <i>to be mounted instead of the original screen / 15,5 cm higher than the original</i>
 KTB82	Specific backrest <i>It cannot be mounted if rack and case are installed</i>

KYMCO **Grand Dink 125-150-250 (00 > 07)**













 KR87	Specific rear rack for MONOKEY ® top case MONOKEY ® plate included
KR870	Specific rear rack for MONOLOCK ® top case MONOLOCK ® plate included
 290DT	Specific screen, transparent 60,6 x 70 cm (H x W) <i>to be combined with the specific D290KIT fitting kit</i>

KYMCO **G-Dink 125-300 (12 > 14)**

 KR6101	Specific rear rack for MONOLOCK ® top case <i>to be combined with the plate already included in the MONOLOCK® top case</i>
 KD6101ST	Specific screen, transparent 75,5 x 57 cm (H x W) <i>to be mounted instead of the original screen / 24,5 cm higher than the original</i>



↘ = Item available until it runs out of stock

CODE	DESCRIPTION	PRICE
KYMCO	K-XCT 125i-300i (13 > 14)	
 KR6103	Specific rear rack for MONOKEY ® top case <i>maximum load allowed 6 kg / MONOKEY® plate included</i>	
KR6103M	Specific rear rack for MONOLOCK ® top case MONOLOCK ® plate included	
 KAF6103	Specific Airstream sliding wind-screen transparent. Maximum height 58 cm (12 cm of excursion), width 57 cm <i>complete with specific fitting kit / to be mounted instead of the original screen</i>	
KD6103ST	Specific screen, transparent 83 x 57 cm (H x W) <i>to be mounted instead of the original screen</i>	
VARIOUS ACCESSORIES	KTB6103	Specific backrest <i>it cannot be mounted if rack and case are installed</i>
KYMCO	Super8 125 (13 > 14) NEW	
 KR6105	Specific rear rack for MONOLOCK ® top case <i>to be combined with the plate already included in the MONOLOCK® top case</i>	
KYMCO	People GTi 125-200-300 (10 > 14)	
 KE1390	Specific rear rack for MONOLOCK ® top case <i>to be combined with the plate already included in the MONOLOCK® top case</i>	
 443A	Specific screen, transparent 53 x 72 cm (H x W) <i>to be combined with the specific A443A fitting kit</i>	
A443A	Specific fitting kit for 443A	
KYMCO	People 250 (04 > 05)	
 KE1360	↘ Specific rear rack for MONOLOCK ® top case <i>to be combined with the plate already included in the MONOLOCK® top case</i>	
KYMCO	Xciting 250-300-500 (05 > 09)	
 KR89	↘ Specific rear rack for MONOKEY ® top case MONOKEY ® plate included	
KR89M	Specific rear rack for MONOLOCK ® top case MONOLOCK ® plate included	
 KD293ST	Specific screen, transparent 87 x 64 cm (H x W) <i>to be mounted instead of the original screen / With hand protectors</i>	
VARIOUS ACCESSORIES	KTB80	↘ Specific backrest <i>It cannot be mounted if rack and case are installed</i>
KYMCO	Xciting 300i-500i R (09 > 14)	
 KR91	Specific rear rack for MONOKEY ® top case MONOKEY ® plate included / maximum load allowed 6 kg	
KR910	Specific rear rack for MONOLOCK ® top case MONOLOCK ® plate included	
 KD295ST	Specific screen, transparent 85.5 x 66 cm (H x W) <i>to be mounted instead of the original screen / 25 cm higher than original</i>	
KAF295	↘ Specific Airstream sliding wind-screen transparent. Maximum height 80 cm (12 cm of extension) width 61 cm. <i>to be mounted instead of the original screen / complete with specific fitting kit / to be mounted instead of the original screen</i>	
VARIOUS ACCESSORIES	KTB81	↘ Specific backrest <i>It cannot be mounted if rack and case are installed</i>
KYMCO	Xciting 400i (13 > 14)	
 KR6104	Specific rear rack for MONOKEY ® top case <i>maximum load allowed 6 kg / MONOKEY® plate included</i>	
KR6104M	Specific rear rack for MONOLOCK ® top case MONOLOCK ® plate included	
 KD6104ST	Specific wind-screen, colour transparent. (H x W) 85,5 x 66 cm <i>to be mounted instead of the original screen / 10 cm higher than the original</i>	
VARIOUS ACCESSORIES	KTB6104	Specific backrest <i>it cannot be mounted if rack and case are installed</i>

MOTORCYCLE ACCESSORIES

CODE	DESCRIPTION	PRICE
------	-------------	-------

KYMCO Myroad 700 (11 > 14)

 KR6100	↘ Specific rear rack for MONOKEY ® top case MONOKEY ® plate included	
KR6100M	↘ Specific rear rack for MONOLOCK ® top case to be combined with the plate already included in the MONOLOCK ® top case	

LML

LML Star 125-150 (09 > 14)

 642A	Specific screen, transparent 54 x 62 cm (H x W) to be combined with the specific A642A fitting kit	
A642A	↘ Specific fitting kit for 642A	

MBK

MBK Ovetto 50-100 (97 > 02)

 KR86	Specific rear rack for MONOLOCK ® top case to be combined with the plate already included in the MONOLOCK ® top case	
----------------------------------------------------------------------------------------------	---------------------------------------------------------------------------------------------------------------------------------------	--



MBK Ovetto 50 (08 > 14)

 KR366	Specific rear rack for MONOLOCK ® top case to be combined with the plate already included in the MONOLOCK ® top case	
 105A	Specific screen, transparent 66 x 67 cm (H x W) to be combined with the specific A285A fitting kit/ With hand protectors	
128A	Specific screen, transparent 74 x 67 cm (H x W) to be combined with the specific A285A fitting kit/ 8 cm higher than 105A	
A285A	Specific fitting kit for 105A and 128A	



MBK Cityliner 125 (07 > 12)

 KR361	↘ Specific rear rack for MONOLOCK ® top case to be combined with the plate already included in the MONOLOCK ® top case	
 KD439ST	Specific screen, transparent with serigraphy 71 x 77 cm (H x W) to be mounted instead of the original screen / 22 cm higher than the original	

MBK Flame X 125 (07 > 12)

 KR354	Specific rear rack for MONOLOCK ® top case to be combined with the plate already included in the MONOLOCK ® top case	
 128A	Specific screen, transparent 74 x 67 cm (H x W) to be combined with the specific A283A fitting kit/ 8 cm higher than 105A	
102A	Specific screen, transparent 66 x 68 cm (H x W) to be combined with the specific A283A fitting kit	
A283A	Specific fitting kit for 102A and 128A	

MBK Skycruiser 125 (05 > 09)

 KR355	Specific rear rack for MONOKEY ® top case you must puncture the housing behind the saddle in arranged sections / MONOKEY ® plate included	
KR3550	Specific rear rack for MONOLOCK ® top case you must puncture the housing behind the saddle in arranged sections / to be combined with the plate already included in the MONOLOCK ® top case	
 KD438ST	Specific screen, transparent 63,5 x 69,5 cm (H x W) to be mounted instead of the original screen / 25,5 cm higher than original	
VARIOUS ACCESSORIES KTB49	Specific backrest It cannot be mounted if rack and case are installed	

MBK Skycruiser 125 (10 > 12)



 KR370	Specific rear rack for MONOKEY ® top case maximum load allowed 6 kg / MONOKEY ® plate included / it is necessary to puncture the housing behind the saddle	
-------------------------------------------------------------------------------------------------	-----------------------------------------------------------------------------------------------------------------------------------------------------------------------------	--





↘ = Item available until it runs out of stock

CODE	DESCRIPTION	PRICE
KR3700	Specific rear rack for MONOLOCK ® top case <i>it is necessary to puncture the housing behind the saddle / to be combined with the plate already included in the MONOLOCK® top case</i>	
 446DT	Specific screen, transparent 73,5 x 63 cm (H x W) <i>to be combined with the specific D446KIT fitting kit/ 30 cm higher than original</i>	
D446KIT	Specific fitting kit for 446DT	
KD446B	Specific low and sports screen gloss black 37 x 43 cm (H x W)	
KAF446	Specific Airstream sliding wind-screen, transparent, complete with fitting kit. Maximum height 70 cm (12 cm of extension), width 62 cm <i>complete with specific fitting kit / to be mounted instead of the original screen</i>	
VARIOUS ACCESSORIES KT55	Specific backrest <i>It cannot be mounted if rack and case are installed</i>	

MBK	Skyliner 125-150 (99 > 00)
 KR43	Specific rear rack for MONOLOCK ® or MONOKEY ® top case <i>to be combined with the K636 MONOKEY® plate, or with the plate already included in the MONOLOCK® top cases</i>

MBK	Skyliner 125-150 cat. (01 > 13)
 KR46	Specific rear rack for MONOKEY ® top case MONOKEY ® plate included
KR460	Specific rear rack for MONOLOCK ® top case MONOLOCK ® plate included
 130DT	Specific screen, transparent 69,2 x 68,2 cm (H x W) <i>to be combined with the specific D130KIT fitting kit</i>
D130KIT	Specific fitting kit for 130DT

MBK	Waap 125 (10 > 12)
 KR373	Specific rear rack for MONOLOCK ® top case <i>to be combined with the plate already included in the MONOLOCK® top case</i>
 288A	Specific screen, transparent 56 x 71,5 cm (H x W) <i>to be combined with the specific A289A fitting kit</i>
A289A	Specific fitting kit for 288A <i>Black colour</i>

MBK	Skyliner 250 (00 > 07)
 KD127ST	Specific screen, transparent 80 x 70,7 cm (H x W) <i>to be mounted instead of the original screen / Without moulding steel / without air intake</i>

MBK	Kilibrè 300 (03 > 07)
 KD432ST	Specific screen, transparent 72 x 75 cm (H x W) <i>to be mounted instead of the original screen / 22 cm higher than the original</i>





MOTO GUZZI

MOTO GUZZI	Breva 750 (03 > 12)
 K7030	Specific rear rack for MONOKEY ® or MONOLOCK ® top case <i>To be combined with the plate MONOKEY® K553N, or with the plate MONOLOCK® MKN/ it is compatible with the original side-case holder / black colour</i>



MOTO GUZZI	Breva 850-1100-1200 (05 > 12)
 KR210	Specific rear rack for MONOKEY ® top case <i>is compatible with the original side case holder / MONOKEY® plate included</i>
KR210M	Specific rear rack for MONOLOCK ® top case <i>is compatible with the original side case holder / MONOLOCK® plate included</i>

MOTO GUZZI	Norge 850-1200 (06 > 14)
 KR210	Specific rear rack for MONOKEY ® top case <i>is compatible with the original side case holder / MONOKEY® plate included</i>
KR210M	Specific rear rack for MONOLOCK ® top case <i>is compatible with the original side case holder / MONOLOCK® plate included</i>





MOTORCYCLE ACCESSORIES

CODE	DESCRIPTION	PRICE
 KD8200ST ↘	Specific screen, transparent 64 x 49 cm (H x W) <i>9 cm higher than original/only for Norge 1200 (10 > 13)</i>	
MOTO GUZZI Stelvio 1200 (08 > 14)		
 K708	Specific rear rack for MONOKEY ® top case MONOKEY ® plate included	
 KL708	Specific pannier holder for MONOKEY ® side cases	
 KD610ST	Specific screen, transparent 61 x 46 cm (H x W) <i>13 cm higher than the original / Only for '08-'09-'10 versions</i>	
VARIOUS ACCESSORIES 01SKIT	Specific kit to mounting the KS900A Smart Bar	

MV AGUSTA

MV AGUSTA Agusta Brutale 750-910		
 BF02K	Specific flange for fitting the tank bags with Tanklock system	
BF05K	Specific flange for fitting the tank bags with Tanklock system	
MV AGUSTA F4 750-1000		
 BF05K	Specific flange for fitting the tank bags with Tanklock system	

PEUGEOT

PEUGEOT Tweet 50-125-150 (10 > 14)		
 107A	Specific screen, transparent 50,8 x 66 cm (H x W) <i>to be combined with the specific A299A fitting kit</i>	
8100A	Specific screen, transparent 50,8 x 66 cm (H x W) <i>to be combined with the specific A8100A fitting kit</i>	
A8100A	Specific fitting kit for 8100A	
PEUGEOT LXR 125-200 (09 > 14)		
 105A	Specific screen, transparent 66 x 67 cm (H x W) <i>to be combined with the specific A298A fitting kit</i>	
128A	Specific screen, transparent 74 x 67 cm (H x W) <i>to be combined with the specific A298A fitting kit/ 8 cm higher than 105A</i>	
A298A	Specific fitting kit for 105A and 128A	
PEUGEOT Geopolis 125-250-400 (07 > 12)		
 KR63 ↘	Specific rear rack for MONOLOCK ® top case <i>to be combined with the plate already included in the MONOLOCK® top case / only for 250 cc. version.</i>	
KR64	Specific rear rack for MONOLOCK ® top case <i>to be combined with the plate already included in the MONOLOCK® top case / only for 400 cc. version.</i>	
PEUGEOT SV 250 (02)		
 KR140	Specific rear rack for MONOLOCK ® or MONOKEY ® top case <i>to be combined with the K636 MONOKEY® plate, or with the plate already included in the MONOLOCK® top cases</i>	
 KD199ST	Specific screen, transparent 49,9 x 72,5 cm (H x W) <i>to be mounted instead of the original screen</i>	
KD199S ↘	Specific wind-screen, smoked colour (H x W) 49,9 cm x 72,5 cm <i>to be mounted instead of the original screen</i>	



↘ = Item available until it runs out of stock

CODE	DESCRIPTION	PRICE
KD202ST	Specific screen, transparent 60 x 74,4 cm (H x W) <i>to be mounted instead of the original screen / 10 cm higher than KD199ST and KD199S</i>	
D199KIT	Kit for a better anchorage of the spoilers: KD199S, KD199ST and KD202ST	

PIAGGIO



PIAGGIO Zip 50 2T / 50 4T (13 > 14)

	6102A	Specific screen, transparent 52 x 66,6 cm (H x W) <i>to be combined with the specific A5607A fitting kit</i>
	A5607A	Specific fitting kit for 6102A



PIAGGIO New Fly 50-125 (12 > 14)

	KR5605	Specific rear rack for MONOLOCK ® top case <i>to be combined with the plate already included in the MONOLOCK® top case / it is necessary to puncture the housing behind the saddle in arranged sections</i>
-----------------------------------------------------------------------------------	---------------	------------------------------------------------------------------------------------------------------------------------------------------------------------------------------------------------------------------------------



PIAGGIO Typhoon 50-125 (11 > 14)

	KR5602	Specific rear rack for MONOLOCK ® top case <i>maximum load allowed 3 kg / to be combined with the plate already included in the MONOLOCK® top case</i>
	288A	Specific screen, transparent 56 x 71,5 cm (H x W) <i>to be combined with the specific A5602A fitting kit</i>
	A5602A	Specific fitting kit, black for 288A

PIAGGIO Vespa Primavera 50-125 (14) **NEW**

	KR5608CR	Specific rear rack for MONOLOCK ® top case, chromed <i>to be combined with the plate already included in the MONOLOCK® top case</i>
	5608A	Specific screen, transparent 50 x 69 cm (H x W) <i>to be combined with the specific A5608A fitting kit</i>
	A5608A	Specific fitting kit for 5608A



PIAGGIO Vespa Sprint 50-125 (14) **NEW**

	KR5608CR	Specific rear rack for MONOLOCK ® top case, chromed <i>to be combined with the plate already included in the MONOLOCK® top case</i>
	5610A	Specific screen, transparent 50 x 69 cm (H x W) <i>to be combined with the specific A5608A fitting kit</i>
	A5608A	Specific fitting kit for 5610A







PIAGGIO Zip 50-125 (00 > 12)

	KR56	Specific rear rack for MONOLOCK ® or MONOKEY ® top case <i>to be combined with the K636 MONOKEY® plate, or with the plate already included in the MONOLOCK® top cases</i>
	6102A	Specific screen, transparent 52 x 66,6 cm (H x W) <i>to be combined with the specific A5607A fitting kit</i>
	A5607A	Specific fitting kit for 6102A

PIAGGIO Fly 50-100-125-150 (04 > 14)











	KR104	Specific rear rack for MONOLOCK ® top case <i>to be combined with the plate already included in the MONOLOCK® top case</i>
	107A	Specific screen, transparent 50,8 x 66 cm (H x W) <i>to be combined with the specific A110A fitting kit</i>
	A110A	Specific fitting kit for 107A

MOTORCYCLE ACCESSORIES











CODE	DESCRIPTION	PRICE
PIAGGIO Liberty 50-125-150 (09 > 14)		
 KR132	Specific rear rack for MONOLOCK ® top case <i>to be combined with the plate already included in the MONOLOCK® top case</i>	
KE3420	Specific rear rack for MONOLOCK ® top case <i>it requires fitment of cases up to 30 ltr / it is necessary to puncture the housing behind the saddle in arranged sections</i>	
 107A	Specific screen, transparent 50,8 x 66 cm (H x W) <i>to be combined with the specific A107A fitting kit</i>	
A107A	Specific fitting kit for 107A	
PIAGGIO Liberty 50 4T / 125 4T / 150 4T (02 > 03)		
 KE3420	Specific rear rack for MONOLOCK ® top case <i>it requires fitment of cases up to 30 ltr / it is necessary to puncture the housing behind the saddle in arranged sections</i>	
PIAGGIO Vespa LX 50-125-150 (05 > 14)		
 KR105	Specific rear rack for MONOLOCK ® top case <i>to be combined with the plate already included in the MONOLOCK® top case</i>	
 104A	Specific screen, transparent 51,5 x 69,5 cm (H x W) <i>to be combined with the specific A104A fitting kit</i>	
A104A	Specific fitting kit for 104A	
PIAGGIO Vespa S 50-125-150 (07 > 14)		
 KR105	Specific rear rack for MONOLOCK ® top case <i>to be combined with the plate already included in the MONOLOCK® top case</i>	
 A354A	Specific fitting kit for 354A	
PIAGGIO Liberty 50-125-150-200 (02 > 08)		
 KR103	Specific plate for MONOLOCK ® boxes <i>only for 125-150-200 cc version</i>	
KE3420	Specific rear rack for MONOLOCK ® top case <i>it requires fitment of cases up to 30 ltr / it is necessary to puncture the housing behind the saddle in arranged sections</i>	
 107A	Specific screen, transparent 50,8 x 66 cm (H x W) <i>to be combined with the specific A107A fitting kit</i>	
A107A	Specific fitting kit for 107A	
PIAGGIO Liberty S 50-125-200 (06 > 12)		
 KR107	Specific rear rack for MONOLOCK ® top case <i>it is necessary to remove the original grab handle / to be combined with the plate already included in the MONOLOCK® top case</i>	
PIAGGIO Vespa PX 125-150 (11 > 14)		
 KR5603	Specific rear rack for MONOLOCK ® top case <i>to be combined with the plate already included in the MONOLOCK® top case</i>	
 642A	Specific screen, transparent 54 x 62 cm (H x W) <i>to be combined with the specific A5603A fitting kit</i>	
A5603A	Specific fitting kit, black for 642A	
PIAGGIO Liberty 125-151 (02 > 08)		
 KE3420	Specific rear rack for MONOLOCK ® top case <i>it requires fitment of cases up to 30 ltr / it is necessary to puncture the housing behind the saddle in arranged sections</i>	
PIAGGIO X9 125-180-250 (00 > 02)		
 KR54	↘ Specific rear rack for MONOKEY ® top case MONOKEY ® plate included	
KR54M	↘ Specific rear rack for MONOLOCK ® top case MONOLOCK ® plate included	
KR57	Specific rear rack for MONOLOCK ® top case <i>to be combined with the plate already included in the MONOLOCK® top case</i>	
KD227ST	↘ Specific screen, transparent 81,2 x 50,1 cm (H x W) <i>to be mounted instead of the original screen / for 250 cc version / only till years '01</i>	



↘ = Item available until it runs out of stock











CODE	DESCRIPTION	PRICE
PIAGGIO Beverly 125-200 (01 > 04)		
 KE3411	Specific rear rack for MONOLOCK ® top case to be combined with the plate already included in the MONOLOCK ® top case	
PIAGGIO Vespa 125-200 granturismo (03 > 08)		
 104A	Specific screen, transparent 51,5 x 69,5 cm (H x W) to be combined with the specific A104A fitting kit	
A104A	Specific fitting kit for 104A	
PIAGGIO Carnaby 125-200 (07 > 11)		
 KE3470	Specific rear rack for MONOLOCK ® top case to be combined with the plate already included in the MONOLOCK ® top case	
PIAGGIO Vespa GTS 125-250 (06 > 14)		
 104A	Specific screen, transparent 51,5 x 69,5 cm (H x W) to be combined with the specific A104A fitting kit	
A104A	Specific fitting kit for 104A	
PIAGGIO X8 125-150-200-250-400 (04 > 10)		
 KR102	Specific rear rack for MONOKEY ® top case MONOKEY ® plate included	
KR102M	Specific rear rack for MONOLOCK ® top case MONOLOCK ® plate included	
 KD500ST	Specific screen, transparent 80 x 60 cm (H x W) to be mounted instead of the original screen / 20 cm higher than the original	
PIAGGIO Mp3 Yourban 125-300 (11 > 14)		
 KR5600	Specific rear rack for MONOKEY ® top case maximum load allowed 6 kg / MONOKEY ® plate included	
KR5600M	Specific rear rack for MONOLOCK ® top case MONOLOCK ® plate included	
KR5600MM	Specific rear rack for MONOLOCK ® top case MONOLOCK ® plate included	
 5600DT	Specific screen, transparent 67 x 74 cm (H x W) to be combined with the specific D5600KIT fitting kit / 35,5 cm higher than the original	
D5600KIT	Specific fitting kit for 5600DT	
KAF5600	Specific Airstream sliding wind-screen transparent. Maximum height 63 cm (12 cm of extension), width 74 cm complete with specific fitting kit / to be mounted instead of the original screen	
KD5600ST	Specific screen, transparent 57 x 44,5 cm (H x W) to be mounted instead of the original screen / 25,5 cm higher than original	
VARIOUS ACCESSORIES KTB5600	Specific backrest it cannot be mounted if rack and case are installed	
PIAGGIO Vespa GTS 125-300 Super (08 > 14)		
 KR131	Specific rear rack for MONOLOCK ® top case to be combined with the plate already included in the MONOLOCK ® top case	
 104A	Specific screen, transparent 51,5 x 69,5 cm (H x W) to be combined with the specific A104A fitting kit	
A104A	Specific fitting kit for 104A	
PIAGGIO X7 EVO 125i-300i (09 > 14)		
 KR133	Specific rear rack for MONOLOCK ® top case to be combined with the plate already included in the MONOLOCK ® top case / You have to puncture the housing of the rear fender	

MOTORCYCLE ACCESSORIES

CODE	DESCRIPTION	PRICE
PIAGGIO Beverly 125-250-400 (04 > 07)		
 KE3411	Specific rear plate for MONOLOCK ® case maximum load allowed 6 kg only for '04 version	
KE3440	Specific rear plate for MONOLOCK ® case maximum load allowed 6 kg compatible from model '05	
PIAGGIO Beverly Tourer 125-250-300-400 (08 > 09)		
 KE3440	Specific rear rack for MONOLOCK ® top case to be combined with the plate already included in the MONOLOCK ® top case	
 103A	Specific screen, transparent 43,5 x 70 cm (H x W) to be combined with the specific A103A fitting kit	
A103A	Specific fitting kit for 103A	
106A	Specific screen, transparent 32 x 61,5 cm (H x W) to be combined with the specific A106A fitting kit/ With hand protectors	
A106A	Specific fitting kit for 106A	
PIAGGIO Beverly 125ie-300ie (10 > 14) / Beverly 350 Sport Touring (12 > 14)		
 KE3490	Specific rear rack for MONOLOCK ® top case to be combined with the plate already included in the MONOLOCK ® top case	
 357A	Specific screen, transparent 32 x 46 cm (H x W) to be combined with the specific A357A fitting kit	
A357A	Specific fitting kit for 357A	
358A	↘ Specific screen, transparent 48,5 x 71 cm (H x W) to be combined with the specific A358A fitting kit	
5606A	Specific screen, transparent 47 x 72 cm (H x W) to be combined with the specific A5606A fitting kit	
A5606A	Specific fitting kit for 5606A	
PIAGGIO Mp3 125 / 250 / 300/ 400 (06 > 11)		
 KR108	Specific rear rack for MONOKEY ® top case complete with polyurethane backrest / MONOKEY ® plate included / in order to fix you must remove the original backrest / maximum load allowed 6 kg	
KR108M	Specific rear rack for MONOLOCK ® top case complete with polyurethane backrest / MONOLOCK ® plate included / in order to fix you must remove the original backrest	
KR134M	"Folding" specific rear rack for MONOLOCK ® top case MONOLOCK ® plate included / complete with polyurethane backrest / allows hardware to be raised in order to fully open the rear trunk	
KR134	"Folding" specific rear rack for MONOKEY ® top case MONOKEY ® plate included / complete with polyurethane backrest / Allows hardware to be raised in order to fully open the rear trunk / maximum load allowed 6 kg	
 KD501ST	Specific screen, transparent 82 x 64 cm (H x W) to be mounted instead of the original screen / 40 cm higher than original (06>08 model), 24 cm higher than original (09-11 model)	
KD502S	↘ Specific screen, smoked 58 x 46 cm (H x W) to be mounted instead of the original screen / 16 cm higher than original (06 > 08 model) / the same height as the original (09-11 model)	
KAF504	Specific Airstream sliding wind-screen, transparent, complete with fitting kit. Maximum height 74 cm (12 cm of extension) width 64 cm to be mounted instead of the original screen / complete with specific fitting kit / to be mounted instead of the original screen	
PIAGGIO X-Evo 125-250-400 (07 > 11)		
 KR102	Specific rear rack for MONOKEY ® top case MONOKEY ® plate included	
KR102M	Specific rear rack for MONOLOCK ® top case MONOLOCK ® plate included	
 KD500ST	Specific screen, transparent 80 x 60 cm (H x W) to be mounted instead of the original screen / 20 cm higher than the original	
PIAGGIO X10 125-350-500 (12 > 14)		
 KR5604	↘ Specific rear rack for MONOKEY ® top case MONOKEY ® plate included	
KR5604M	↘ Specific rear rack for MONOLOCK ® top case MONOLOCK ® plate included	
 KD5604ST	Specific screen, transparent 85,5 x 69 cm (H x W) to be mounted instead of the original screen	
KAF5604	Specific Airstream sliding wind-screen transparent. Maximum height 77 cm (12 cm of extension), width 68 cm complete with specific fitting kit / to be mounted instead of the original screen	



↘ = Item available until it runs out of stock

CODE	DESCRIPTION	PRICE
PIAGGIO X9 200-250-500 Evolution (03 > 08)		
 KR54	Specific rear rack for MONOKEY ® top case MONOKEY ® plate included	
KR54M	Specific rear rack for MONOLOCK ® top case MONOLOCK ® plate included	
KR57	Specific rear rack for MONOLOCK ® top case to be combined with the plate already included in the MONOLOCK ® top case	
 KD229ST	Specific screen, transparent 65 x 50 cm (H x W) to be mounted instead of the original screen / 16 cm higher than the original	
PIAGGIO Beverly Cruiser 250 - 500 (07 > 11)		
 K345	Specific rear rack for MONOKEY ® top case MONOKEY ® plate included / maximum load allowed 6 Kg / it is necessary to puncture the housing behind the saddle in arranged sections	
 352A	Specific screen, transparent with serigraphy 50,5 x 78,5 cm (H x W) to be combined with the specific A352A fitting kit	
A352A	Specific fitting kit for 352A	
VARIOUS ACCESSORIES KTB105	Specific backrest	
PIAGGIO Carnaby Cruiser 300 (09 > 12)		
 KE3480	Specific rear rack for MONOLOCK ® top case to be combined with the plate already included in the MONOLOCK ® top case	
 356A	Specific screen, transparent 50 x 77 cm (H x W) to be combined with the specific A352A fitting kit	
A352A	Specific fitting kit for 356A	
PIAGGIO Mp3 Touring 300 - 400 (11) / Mp3 Business 300 (12 > 14) / Mp3 Sport 300 (12 > 14) / Mp3 Business 500 (12 > 13) / Mp3 Sport 500 (12 > 13)		
 KR134M	"Folding" specific rear rack for MONOLOCK ® top case MONOLOCK ® plate included / complete with polyurethane backrest / allows hardware to be raised in order to fully open the rear trunk	
KR134	"Folding" specific rear rack for MONOKEY ® top case MONOKEY ® plate included / complete with polyurethane backrest / Allows hardware to be raised in order to fully open the rear trunk / maximum load allowed 6 kg	
KR108	Specific rear rack for MONOKEY ® top case complete with polyurethane backrest / MONOKEY ® plate included / in order to fix you must remove the original backrest / maximum load allowed 6 kg	
KR108M	Specific rear rack for MONOLOCK ® top case complete with polyurethane backrest / MONOLOCK ® plate included / in order to fix you must remove the original backrest	
 KAF5601	Specific Airstream sliding wind-screen transparent. Maximum height 67 cm (12 cm of extension), width 65 cm to be mounted instead of the original screen	
KD5601ST	Specific screen, transparent 75 x 65 cm (H x W) to be mounted instead of the original screen / 12 cm higher than the original	
PIAGGIO Mp3 500ie Sport / 500ie Business (14) NEW		
 KR5609	Specific rear rack for MONOKEY ® top case MONOKEY ® plate included	
KR5609M	Specific rear rack for MONOLOCK ® top case to be combined with the plate already included in the MONOLOCK ® top case	
PIAGGIO Beverly 500 (03 > 07)		
 KE3411	Specific rear plate for MONOLOCK ® case maximum load allowed 6 kg / compatible with '03 and '04	
KE3440	Specific rear plate for MONOLOCK ® case maximum load allowed 6 kg / compatible from '05	
 103A	Specific screen, transparent 43,5 x 70 cm (H x W) to be combined with the specific A103A fitting kit	
A103A	Specific fitting kit for 103A	
106A	Specific screen, transparent 32 x 61,5 cm (H x W) to be combined with the specific A106A fitting kit / With hand protectors	
A106A	Specific fitting kit for 106A	



MOTORCYCLE ACCESSORIES

CODE	DESCRIPTION	PRICE
PIAGGIO X9 500 (01 > 02)		
 KR54	↘ Specific rear rack for MONOKEY ® top case MONOKEY ® plate included	
KR54M	↘ Specific rear rack for MONOLOCK ® top case MONOLOCK ® plate included	
KR57	Specific rear rack for MONOLOCK ® top case to be combined with the plate already included in the MONOLOCK ® top case	



SUZUKI



CODE	DESCRIPTION	PRICE
SUZUKI Sixteen 125-150 (08 > 14)		
 169A	Specific screen, transparent with serigraphy 56,5 x 71,5 cm (H x W) to be combined with the specific A169A fitting kit/ With hand protectors	
A169A	Specific fitting kit for 169A	

CODE	DESCRIPTION	PRICE
SUZUKI UH 125-150 Burgman (02 > 06)		
 KR114	Specific rear rack for MONOLOCK ® top case to be combined with the plate already included in the MONOLOCK ® top case / it is necessary to puncture the housing behind the saddle	
 KD256ST	Specific screen, transparent 83 x 53 cm (H x W) to be mounted instead of the original screen / 20 cm higher than the original / with hand protectors	

CODE	DESCRIPTION	PRICE
SUZUKI Burgman 125-200 K7-K8-K9-L0-L1-L2-L3 (06 > 13)		
 KR117M	↘ Specific rear rack for MONOLOCK ® top case MONOLOCK ® plate included / you must remove the grabrails, they are reproduced by the rack itself / it is necessary to puncture the housing behind the saddle	
KR1180	↘ Specific rear rack for MONOLOCK ® top case it is necessary to puncture the housing behind the saddle / to be combined with the plate already included in the MONOLOCK ® top case	
KR3106	Specific rear rack for MONOLOCK ® top case to be combined with the plate already included in the MONOLOCK ® top case	
 3106DT	Specific screen, transparent 84,5 x 65,5 cm (H x W) to be combined with the specific D267KIT fitting kit / 21,5 cm higher than the original	
267DT	Specific screen, transparent 84,5 x 65,5 cm (H x W) to be combined with the specific D267KIT fitting kit / 21,5 cm higher than the original	
D267KIT	Specific fitting kit for 267DT and 3106DT	
KD3106ST	Specific screen, transparent 72 x 67 cm (H x W) to be mounted instead of the original screen	













VARIOUS ACCESSORIES	KTB3106	Specific backrest it is necessary to puncture the housing behind the saddle in arranged sections	
----------------------------	----------------	-----------------------------------------------------------------------------------------------------	--

CODE	DESCRIPTION	PRICE
SUZUKI Burgman 125-200 ABS (14) NEW		
 KR3106	Specific rear rack for MONOLOCK ® top case to be combined with the plate already included in the MONOLOCK ® top case	
 3106DT	Specific screen, transparent 84,5 x 65,5 cm (H x W) to be combined with the specific D267KIT fitting kit / 21,5 cm higher than the original	
D267KIT	Specific fitting kit for 3106DT	
KD3106ST	Specific screen, transparent 72 x 67 cm (H x W) to be mounted instead of the original screen	













CODE	DESCRIPTION	PRICE
SUZUKI AN 250-400 Burgman (98 > 02)		
 KR111	Specific rear rack for MONOKEY ® top case MONOKEY ® plate included / it is necessary to puncture the housing behind the saddle	
KR111M	Specific rear rack for MONOLOCK ® top case MONOLOCK ® plate included / it is necessary to puncture the housing behind the saddle	
 156ST	Specific screen, transparent 72,5 x 79,5 cm (H x W) to be combined with the specific 156D fitting kit	
156S	↘ Specific screen, smoked 72,5 x 79,5 cm (H x W) to be combined with the specific 156D fitting kit	
156D	Specific fitting kit for 156S and 156ST	



↘ = Item available until it runs out of stock

CODE	DESCRIPTION	PRICE
SUZUKI AN 250-400 Business (01 > 03)		
 KR112	Specific rear rack for MONOKEY ® top case MONOKEY ® plate included / maximum load allowed 3 kg	
 156ST	Specific screen, transparent 72,5 x 79,5 cm (H x W) to be combined with the specific 156D fitting kit	
156S	Specific screen, smoked 72,5 x 79,5 cm (H x W) to be combined with the specific 156D fitting kit	
156D	Specific fitting kit for 156S and 156ST	
SUZUKI AN 250-400 Burgman (03 > 06)		
 KR115	Specific rear rack for MONOKEY ® top case MONOKEY ® plate included / it is necessary to puncture the housing behind the saddle	
KR1150	Specific rear rack for MONOLOCK ® top case MONOLOCK ® plate included	
 KD258ST	Specific screen, transparent 80 x 71 cm (H x W) to be mounted instead of the original screen / 17 cm higher than the original / with hand protectors	
SUZUKI Inazuma 250 (12 > 14)		
 KR3103	Specific rear rack for MONOLOCK ® top case to be combined with the plate already included in the MONOLOCK ® top case / it is necessary to puncture the housing behind the saddle	
 KL3103	Specific pannier holder for MONOKEY ® side cases it can be mounted only with the specific rear rack KR3103 / you can only mount cases MONOKEY ® K21	
SUZUKI AN 400 Burgman Type-S (05)		
 KD258ST	Specific screen, transparent 80 x 71 cm (H x W) to be mounted instead of the original screen / 17 cm higher than the original / with hand protectors	
SUZUKI Burgman 400 K7 -K8- K9-L0-L1-L2 (06 > 14)		
 K531E	Specific rear rack for MONOKEY ® top case MONOKEY ® plate included / it is necessary to puncture the housing behind the saddle in arranged sections	
K531M	Specific rear rack for MONOLOCK ® top case MONOLOCK ® plate included / it is necessary to puncture the housing behind the saddle	
 266DT	Specific screen, transparent 84 x 68 cm (H x W) to be combined with the specific D266KIT fitting kit / 16 cm higher than the original	
D266KIT	Specific fitting kit for 266DT	
KAF266	Specific Airstream sliding wind-screen transparent. Maximum height 81 cm (12 cm of extension) width 67 cm complete with specific fitting kit / to be mounted instead of the original screen	
VARIOUS ACCESSORIES KTB531	Specific backrest it can be mounted only if K531E / K531M are installed	
KTB532	Specific backrest It cannot be mounted if rack and case are installed	
SUZUKI GS 500 E (97 > 00)		
 K5240	Specific rear rack for MONOKEY ® or MONOLOCK ® top case To be combined with the plate MONOKEY ® K553N, or with the plate MONOLOCK ® MKN	
SUZUKI GS 500 E (01 > 07) / GS 500 F (04)		
 K5260	Specific rear rack for MONOKEY ® or MONOLOCK ® top case To be combined with the plate MONOKEY ® K553N, or with the plate MONOLOCK ® MKN	
SUZUKI GSF 600 Bandit / S (96 > 99)		
 K5110	Specific rear rack for MONOKEY ® or MONOLOCK ® top case To be combined with the plate MONOKEY ® K553N, or with the plate MONOLOCK ® MKN	
 KN43	Specific engine guard we recommend fitting by a qualified mechanic	

MOTORCYCLE ACCESSORIES



















CODE	DESCRIPTION	PRICE
SUZUKI GSF 600 Bandit / S (00 > 04)		
 K5220	Specific rear rack for MONOKEY ® or MONOLOCK ® top case <i>To be combined with the plate MONOKEY® K553N, or with the plate MONOLOCK® MKN</i>	
 KN43	Specific engine guard <i>we recommend fitting by a qualified mechanic</i>	
SUZUKI GSR 600 (06 > 11)		
 KR116	Specific rear rack for MONOKEY ® top case MONOKEY ® plate included / you must remove the grabrails / maximum load allowed 6 kg	
KR116M	Specific rear rack for MONOLOCK ® top case MONOLOCK ® plate included / you must remove the grabrails	
 KLX538	Specific pannier holder for K33 MONOKEY ® SIDE cases <i>it can be mounted only with the specific rear rack KR116 / KR116M</i>	
 TK255	Specific holder for soft side bags <i>to be mounted only with KR116 / KR116M</i>	
 BF01K	Specific flange for fitting the tank bags with Tanklock system	
 245N	Universal screen, black 33,5 x 29 cm (H x W) <i>to be combined with the specific A167A fitting kit / The inside is painted in matt colour to prevent the front light from reflecting</i>	
A167A	Specific fitting kit for 245A, 245N and 246____ <i>compatible with '06 and '07</i>	
247A	↘ Universal screen, smoked 29 x 28,5 cm (H x W) <i>to be combined with the specific A170A fitting kit</i>	
247N	Specific screen, black 29 x 28,5 cm (H x W) <i>to be combined with the specific A170A fitting kit</i>	
A170A	Specific fitting kit for 247A and 247N <i>compatible from '08 - '11 model</i>	
 KN535	Specific engine guard <i>we recommend fitting by a qualified mechanic</i>	
SUZUKI GSX 600 F (98 > 02)		
 K5180	Specific rear rack for MONOKEY ® or MONOLOCK ® top case <i>To be combined with the plate MONOKEY® K553N, or with the plate MONOLOCK® MKN</i>	
SUZUKI GSX 600 F (03 > 06)		
 KZ530	Specific rear rack for MONOKEY ® or MONOLOCK ® top case <i>to be combined with the MONOKEY® KM5 or KM7 plates, or with the MONOLOCK® KM5M or KM6M plates</i>	
SUZUKI GSX R 600 / 750 (08 > 10)		
 BF01K	Specific flange for fitting the tank bags with Tanklock system <i>only for SUZUKI GSX R 600/750 (06 > 10)</i>	
SUZUKI AN 650 Burgman Executive (02 > 12)		
 K529	Specific rear rack for MONOKEY ® top case <i>the rack cannot be mounted in conjunction with the KTB529 / MONOKEY® plate included / in order to install it you must remove the original backrest / it is necessary to puncture the housing behind the saddle in arranged sections</i>	
K529M	Specific rear rack for MONOLOCK ® top case MONOLOCK ® plate included / It cannot be combined with KTB529 / in order to install it you must remove the original backrest / it is necessary to puncture the housing behind the saddle in arranged sections	
KR3104	Specific rear rack for MONOKEY ® top case MONOKEY ® plate included / it is necessary to puncture the housing behind the saddle in arranged sections	
KR3104MM	Specific rear rack for MONOLOCK ® top case MONOLOCK ® plate with place for the "u" type padlock included / it is necessary to puncture the housing behind the saddle in arranged sections	
 KD257ST	Specific screen, transparent 80 x 72 cm (H x W) <i>to be mounted instead of the original screen / compatible with all years '02 - '04</i>	
KD263ST	Specific screen, transparent 78,5 x 72 cm (H x W) <i>to be mounted instead of the original screen / for models having electrically adjustable screen / compatible from '05</i>	
SUZUKI 650 Burgman / 650 Burgman Executive (13 > 14)		
 KR3104	Specific rear rack for MONOKEY ® top case MONOKEY ® plate included / it is necessary to puncture the housing behind the saddle in arranged sections	
KR3104MM	Specific rear rack for MONOLOCK ® top case MONOLOCK ® plate with place for the "u" type padlock included / it is necessary to puncture the housing behind the saddle in arranged sections	
 KL3104	Specific pannier holder for MONOKEY ® side cases <i>it can be mounted only with the specific rear rack KR3104 / you can only mount cases MONOKEY® K21 CRUISER</i>	



↘ = Item available until it runs out of stock



















CODE	DESCRIPTION	PRICE
 SR3104KIT	Specific kit to install the KR3104 on the KR3104MM on Suzuki Burgman 650 Executive (13)	
 KD3104ST	Specific screen, transparent 76 x 75 cm (H x W) <i>to be mounted instead of the original screen / 12 cm higher than original</i>	
SUZUKI DL 650 V-Strom (04 > 11)		
 K528M	Specific rear rack for MONOLOCK ® top case <i>to be combined with the plate already included in the MONOLOCK® top case</i>	
 KL532	Specific pannier holder for MONOKEY ® side cases	
KLX532	Specific pannier holder for K33 MONOKEY ® SIDE cases	
 BF10K	Specific flange for fitting the tank bags with Tanklock system	
 KD260ST	Specific screen, transparent 57 x 48 cm (H x W) <i>18 cm higher than original / only with spoiler / only from '04 to '11</i>	
KAF260	Specific Airstream sliding wind-screen, transparent, complete with fitting kit. Maximum height 65 cm (12 cm of extension) width 44 cm <i>to be mounted instead of the original screen</i>	
 KN532	Specific engine guard <i>we recommend fitting by a qualified mechanic</i>	
VARIOUS ACCESSORIES 05SKIT	Specific kit to mounting the KS900A Smart Bar	
ES3101K	Specific support in aluminum and stainless steel to widen the surface support area of the original side stand	
KMG532	Mudguard/specific ABS chain-cover, black colour	
SUZUKI DL 650 V-Strom L2-L3 (11 > 14)		
 KR3101	Specific rear rack for MONOKEY ® top case MONOKEY ® plate included	
KR3101M	Specific rear rack for MONOLOCK ® top case <i>to be combined with the plate already included in the MONOLOCK® top case</i>	
KRA3101	Specific rear rack in aluminium for MONOKEY ® top case, black <i>maximum load allowed 6kg / it does not allow the assembly of the stop light kit or the remote control device on the case</i>	
 KL3101	Specific pannier holder for MONOKEY ® side cases	
KLR3101	Specific rapid release side case holder for MONOKEY ® cases	
KLX3101	Specific pannier holder for K33 MONOKEY ® SIDE cases	
 BF01K	Specific flange for fitting the tank bags with Tanklock system	
 3101DT	Specific screen, transparent 52 x 46 cm (H x W) <i>to be combined with the specific D3101KIT fitting kit</i>	
D3101KIT	Specific fitting kit for 3101DT	
KAF3101	Specific Airstream sliding wind-screen transparent. Maximum height 56 cm (12 cm of extension), width 43 cm <i>complete with specific fitting kit / to be mounted instead of the original screen</i>	
 KN3101	Specific engine guard <i>we recommend fitting by a qualified mechanic / compatible with the original tip, as well as the oil carter protector RP3101</i>	
RP3101	Oil carter protector in Aluminium	
VARIOUS ACCESSORIES KMG3101	Mudguard/specific ABS chain-cover, black colour	
ES3101K	Specific support in aluminum and stainless steel to widen the surface support area of the original side stand	
05SKIT	Specific kit to mounting the KS900A Smart Bar	
SUZUKI Gladius 650 (09 > 14)		
 KR121	Specific rear rack for MONOKEY ® top case MONOKEY ® plate included / you must remove the grabrails, they are reproduced by the rack itself / maximum load allowed 6 kg	
KR121M	Specific rear rack for MONOLOCK ® top case MONOLOCK ® plate included / you must remove the grabrails, they are reproduced by the rack itself	
 KLX540	Specific pannier holder for K33 MONOKEY ® SIDE cases	

MOTORCYCLE ACCESSORIES















CODE	DESCRIPTION	PRICE
 BF01K	Specific flange for fitting the tank bags with Tanklock system	
 KA172	Specific screen, smoked 29,5 x 30,5 cm (H x W) <i>Complete with fitting kit</i>	
KA172S	↘ Specific screen, black and grey 29,5 x 30,5 cm (H x W)	
VARIOUS ACCESSORIES 05SKIT	Specific kit to mounting the KS900A Smart Bar	
SUZUKI GSF 650 Bandit / Bandit S / Bandit ABS (05 > 06)		
 KZ539	Specific rear rack for MONOKEY ® or MONOLOCK ® top case <i>to be combined with the MONOKEY® KM5 or KM7 plates, or with the MONOLOCK® KM5M or KM6M plates</i>	
 KL534	↘ Specific pannier holder for MONOKEY ® side cases <i>you must move from there original position / only for version without ABS</i>	
 KD262S	Specific screen, fumè 45,7 x 36,5 cm (H x W) <i>11,7 cm higher than original / for semi faired version</i>	
SUZUKI GSF 650 Bandit / GSF 650 Bandit S K7-K8 (07 > 11)		
 KZ539	Specific rear rack for MONOKEY ® or MONOLOCK ® top case <i>to be combined with the MONOKEY® KM5 or KM7 plates, or with the MONOLOCK® KM5M or KM6M plates</i>	
 KL539	Specific pannier holder for MONOKEY ® side cases <i>you must move the indicators from their original position</i>	
KLX539	Specific pannier holder for K33 MONOKEY ® SIDE cases <i>you must move the indicators from their original position</i>	
 245N	Universal screen, black 33,5 x 29 cm (H x W) <i>to be combined with the specific A168A fitting kit</i>	
KD262S	Specific screen, fumè 45,7 x 36,5 cm (H x W) <i>11,7 cm higher than original / for semi faired version</i>	
 KN3102	↘ Specific engine guard <i>we recommend fitting by a qualified mechanic / black colour</i>	
SUZUKI GSF 650 BANDIT / GSF BANDIT S K9-L0-L1-L2 (09 > 14)		
 KZ540	Specific rear rack for MONOKEY ® or MONOLOCK ® top case <i>to be combined with the MONOKEY® KM5 or KM7 plates, or with the MONOLOCK® KM5M or KM6M plates</i>	
 KLXR541	Specific rapid release side case holder for K33 MONOKEY ® SIDE cases <i>you must move the indicators from their original position</i>	
 BF01K	Specific flange for fitting the tank bags with Tanklock system	
 KN3102	↘ Specific engine guard <i>we recommend fitting by a qualified mechanic / black colour</i>	
VARIOUS ACCESSORIES 05SKIT	Specific kit to mounting the KS900A Smart Bar <i>only for version GSF650 Bandit S</i>	
SUZUKI GSX 650 F (08 > 14) / GSX 1250 F (10 > 14)		
 KZ539	Specific rear rack for MONOKEY ® or MONOLOCK ® top case <i>to be combined with the MONOKEY® KM5 or KM7 plates, or with the MONOLOCK® KM5M or KM6M plates</i>	
 KL539	Specific pannier holder for MONOKEY ® side cases <i>you must move the indicators from their original position</i>	
KLX539	Specific pannier holder for K33 MONOKEY ® SIDE cases <i>you must move the indicators from their original position</i>	
 BF01K	Specific flange for fitting the tank bags with Tanklock system	
 KD270S	Specific screen, smoked 45 x 38,5 cm (H x W) <i>10,5 cm higher than the original</i>	
VARIOUS ACCESSORIES 05SKIT	Specific kit to mounting the KS900A Smart Bar	
SUZUKI SV 650 / SV 650 S (03 > 08)		
 KZ529	Specific rear rack for MONOKEY ® or MONOLOCK ® top case <i>to be combined with the MONOKEY® KM5 or KM7 plates, or with the MONOLOCK® KM5M or KM6M plates</i>	



↘ = Item available until it runs out of stock



CODE	DESCRIPTION	PRICE
SUZUKI GSX 750 (98 > 02)		
 K5170	Specific rear rack for MONOKEY ® or MONOLOCK ® top case <i>To be combined with the plate MONOKEY® K553N, or with the plate MONOLOCK® MKN</i>	
 KN43	Specific engine guard <i>we recommend fitting by a qualified mechanic</i>	
SUZUKI GSX 750 F (98 > 02)		
 K5180	Specific rear rack for MONOKEY ® or MONOLOCK ® top case <i>To be combined with the plate MONOKEY® K553N, or with the plate MONOLOCK® MKN</i>	
SUZUKI GSX 750 F (03 > 06)		
 KZ530	Specific rear rack for MONOKEY ® or MONOLOCK ® top case <i>to be combined with the MONOKEY® KM5 or KM7 plates, or with the MONOLOCK® KM5M or KM6M plates</i>	
SUZUKI GSR 750 (11 > 14)		
 KZ3100	Specific rear rack for MONOKEY ® or MONOLOCK ® top case <i>to be combined with the MONOKEY® KM5 or KM7 plates, or with the MONOLOCK® KM5M or KM6M plates</i>	
 TE3100K	Specific holder for soft side bags <i>it can be mounted without the specific rear rack KZ3100 using the 3100KIT / you must move the indicators from their original position</i>	
3100KIT	Specific kit to install the TE3100K without the specific rear rack	
 BF01K	Specific flange for fitting the tank bags with Tanklock system	
 KA3100	Specific screen, smoked 32 x 30 cm (H x W) <i>Complete with fitting kit</i>	
VARIOUS ACCESSORIES 05SKIT	Specific kit to mounting the KS900A Smart Bar	
SUZUKI DL 1000 V-Strom (02 > 11)		
 K528M	Specific rear rack for MONOLOCK ® top case <i>to be combined with the plate already included in the MONOLOCK® top case</i>	
 KL528	Specific pannier holder for MONOKEY ® side cases	
KLX528	Specific pannier holder for K33 MONOKEY ® SIDE cases	
 TKB09	 Specific "Tanky" base for Suzuki DL V-Storm (04-10), compatible with the tank bags TKB751 - TKB754	
 BF10K	Specific flange for fitting the tank bags with Tanklock system	
 KD260ST	Specific screen, transparent 57 x 48 cm (H x W) <i>18 cm higher than original / only with spoiler / compatible for all years '04</i>	
KAF260	Specific sliding wind-screen transparent, Airstream. Maximum height 65 cm (12 cm of extension) width 44 cm <i>complete with specific fitting kit / to be mounted instead of the original screen / compatible from year '04</i>	
 KN46	Specific engine guard <i>we recommend fitting by a qualified mechanic</i>	
SUZUKI DL 1000 V-Strom (14) NEW		
 KR3105	Specific rear rack for MONOKEY ® top case <i>maximum load allowed 6 kg / MONOKEY® plate included</i>	
KRA3105	Specific rear rack in aluminium for MONOKEY ® top case <i>maximum load allowed 6kg / it does not allow the assembly of the stop light kit or the remote control device on the case</i>	
KR3105M	Specific rear rack for MONOLOCK ® top case <i>MONOLOCK® plate included</i>	
 KLR3105	Specific rapid release side case holder for MONOKEY ® cases	
 BF18K	Specific flange for fitting the tank bags with Tanklock system	
 KD3105ST	Specific screen, transparent 50 x 39,5 cm (h x w) <i>to be mounted instead of the original screen / 22 cm higher than original</i>	
KAF3105	Specific sliding wind-screen transparent, AIRSTREAM®. Maximum height 50 cm (12 cm of extension) width 44 cm <i>complete with specific fitting kit / to be mounted instead of the original screen</i>	

MOTORCYCLE ACCESSORIES

CODE	DESCRIPTION	PRICE
 KN3105	Specific engine guard <i>we recommend fitting by a qualified mechanic / black colour</i>	
VARIOUS ACCESSORIES KMG3105	Mudguard/specific ABS chain-cover, black colour	
KHP3105	Hand protector specific ABS	
ES3105K	Specific support in aluminum and stainless steel to widen the surface support area of the original side stand	
 RP3105	Oil carter protector in Aluminium	
VARIOUS ACCESSORIES 02SKIT	Specific kit to mounting the KS900A Smart Bar	
SUZUKI	GSX R 1000 (09 > 12)	
 BF01K	Specific flange for fitting the tank bags with Tanklock system	
SUZUKI	SV 1000 / SV 1000 S (03 > 07)	
 KZ529	Specific rear rack for MONOKEY ® or MONOLOCK ® top case <i>to be combined with the MONOKEY® KM5 or KM7 plates, or with the MONOLOCK® KM5M or KM6M plates</i>	
SUZUKI	GSX 1200 (98 > 02)	
 K5170	Specific rear rack for MONOKEY ® or MONOLOCK ® top case <i>To be combined with the plate MONOKEY® K553N, or with the plate MONOLOCK® MKN</i>	
SUZUKI	GSF 1200 Bandit (96 > 99)	
 K5110	Specific rear rack for MONOKEY ® or MONOLOCK ® top case <i>To be combined with the plate MONOKEY® K553N, or with the plate MONOLOCK® MKN</i>	
SUZUKI	GSF 1200 Bandit / Bandit S (00 > 05)	
 K5220	Specific rear rack for MONOKEY ® or MONOLOCK ® top case <i>To be combined with the plate MONOKEY® K553N, or with the plate MONOLOCK® MKN</i>	
 KL523	↘ Specific pannier holder for MONOKEY ® side cases <i>you must move the indicators from their original position</i>	
SUZUKI	GSF 1200 Bandit / Bandit S (06)	
 KZ539	Specific rear rack for MONOKEY ® or MONOLOCK ® top case <i>to be combined with the MONOKEY® KM5 or KM7 plates, or with the MONOLOCK® KM5M or KM6M plates</i>	
 KD262S	Specific screen, smoked 45,7 x 36,5 cm (H x W) <i>11,7 cm higher than the original / made only for version GSF 650/1250 Bandit S</i>	
SUZUKI	GSF 1250 Bandit / Bandit S (07 > 11)	
 KZ539	Specific rear rack for MONOKEY ® or MONOLOCK ® top case <i>to be combined with the MONOKEY® KM5 or KM7 plates, or with the MONOLOCK® KM5M or KM6M plates</i>	
 KL539	Specific pannier holder for MONOKEY ® side cases <i>you must move the indicators from their original position</i>	
KLX539	Specific pannier holder for K33 MONOKEY ® SIDE cases <i>you must move the indicators from their original position</i>	
 245N	Universal screen, black 33,5 x 29 cm (H x W) <i>to be combined with the specific A168A fitting kit</i>	
KD262S	Specific screen, smoked 45,7 x 36,5 cm (H x W) <i>11,7 cm higher than the original / made only for version GSF 650/1250 Bandit S</i>	
VARIOUS ACCESSORIES 05SKIT	Specific kit to mounting the KS900A Smart Bar	
SUZUKI	GSX 1250 F (10)	
 BF01K	Specific flange for fitting the tank bags with Tanklock system	





↘ = Item available until it runs out of stock

CODE	DESCRIPTION	PRICE
SUZUKI	GSX 1300R Hayabusa (08 > 14)	
 KZ541	Specific rear rack for MONOKEY ® or MONOLOCK ® top case to be combined with the MONOKEY ® KM5 or KM7 plates, or with the MONOLOCK ® KM5M or KM6M plates / a handle bar for the passenger is included, you must remove the original grab rails / maximum load allowed 6 kg	
 BF01K	Specific flange for fitting the tank bags with Tanklock system	

SUZUKI	GSX 1400 (02 > 09)	
 KZ527	Specific rear rack for MONOKEY ® or MONOLOCK ® top case to be combined with the MONOKEY ® KM5 or KM7 plates, or with the MONOLOCK ® KM5M or KM6M plates	
 KN45	Specific engine guard we recommend fitting by a qualified mechanic	



SYM

SYM	Fiddle II 50-125 (09 > 14)	
K628	Universal plate included in Monolock® top-cases box.	
 293A	Specific screen, transparent 50 x 63 cm (H x W) to be combined with the specific A293A fitting kit	
A293A	Specific fitting kit for 293A	









SYM	Symphony 50-125-151 (09 > 14)	
 KE2920	Specific rear rack for MONOLOCK ® top case to be combined with the plate already included in the MONOLOCK ® top case / maximum load allowed 3 kg	
 A294A	↘ Specific fitting kit for 294A and 296A (09-10) / Made only for 50 cc version	
A295A	↘ Specific fitting kit for 294A and 296A Only for 125 cc. version / only for 09-10	
107A	Specific screen, transparent 50,8 x 66 cm (H x W) to be combined with the specific A299A fitting kit	
7053A	Specific screen, transparent with serigraphy to be combined with the specific A7053A fitting kit	
A7053A	Specific fitting kit for 7053A	

SYM	Symphony SR 50-125-151 (10 > 14)	
 297A	Specific screen, transparent 62 x 71 cm (H x W) to be combined with the specific A297A fitting kit	
A297A	Specific fitting kit for 297A	







SYM	Joyride 125-150-200 (01 > 07)	
 KR99	Specific rear rack for MONOLOCK ® or MONOKEY ® top case to be combined with the K636 MONOKEY ® plate, or with the plate already included in the MONOLOCK ® top cases	

SYM	HD Evo 125-200 (07 > 14)	
 KE2910	↘ Specific rear rack for MONOLOCK ® top case to be combined with the plate already included in the MONOLOCK ® top case	
 128A	Specific screen, transparent 74 x 67 cm (H x W) to be combined with the specific A298A fitting kit / 8 cm higher than 105A	
105A	Specific screen, transparent 66 x 67 cm (H x W) to be combined with the specific A298A fitting kit	
A298A	Specific fitting kit for 105A and 128A	

MOTORCYCLE ACCESSORIES

CODE	DESCRIPTION	PRICE
SYM	HD2 125-200 (11 > 14)	
 105A	Specific screen, transparent 66 x 67 cm (H x W) <i>to be combined with the specific A7050A fitting kit</i>	
128A	Specific screen, transparent 74 x 67 cm (H x W) <i>to be combined with the specific A7050A fitting kit/ 8 cm higher than 105A</i>	
A7050A	Specific fitting kit for 105A and 128A	
SYM	Joymax 250 (05 > 08) / Joymax Evo (09 > 11) / GTS (11>02)	
 KR230	Specific rear rack for MONOLOCK ® or MONOKEY ® top case <i>to be combined with the K636 MONOKEY® plate, or with the plate already included in the MONOLOCK® top cases</i>	
KR2320	Specific rear rack for MONOLOCK ® top case <i>to be combined with the plate already included in the MONOLOCK® top case</i>	
SYM	Citycom 300 (08 > 14)	
 KR231	Specific rear rack for MONOKEY ® top case MONOKEY ® plate included / you must puncture the housing behind the saddle in arranged sections	
KR2310	Specific rear rack for MONOLOCK ® top case <i>to be combined with the plate already included in the MONOLOCK® top case / you must puncture the housing behind the saddle in arranged sections</i>	
 KD650ST	Specific screen, transparent 64 x 55 cm (H x W) <i>to be mounted instead of the original screen / 19 cm higher than original</i>	
SYM	Joymax 300i (12 > 14)	
 KR7052	Specific rear rack for MONOKEY ® top case <i>maximum load allowed 6 kg / MONOKEY® plate included</i>	
KR7052M	Specific rear rack for MONOLOCK ® top case MONOLOCK ® plate included	
 KD7052ST	Specific screen, transparent with handguards 82 x 59 cm (H x W) <i>to be mounted instead of the original screen / 16.5 cm higher than the original</i>	
SYM	Maxsym 400 (11 > 14)	
 KR7051	Specific rear rack for MONOKEY ® top case MONOKEY ® plate included	
KR7051M	Specific rear rack for MONOLOCK ® top case MONOLOCK ® plate included	
 7051DT	Specific screen, transparent 74 x 64 cm (H x W) <i>to be combined with the specific D7051KIT fitting kit/ 12 cm higher than original</i>	
D7051KIT	Specific fitting kit for 7051DT	

TRIUMPH

TRIUMPH	Daytona 675	
 BF02K	Specific flange for fitting the tank bags with Tanklock system	
TRIUMPH	Street Triple 675 (07 > 12)	
 KZ727	Specific rear rack for MONOKEY ® or MONOLOCK ® top case <i>to be combined with the MONOKEY® KMS or KM7 plates, or with the MONOLOCK® KMSM or KM6M plates / maximum load allowed 6 kg</i>	
 TE705K	Specific holder for soft side bags	
 BF02K	Specific flange for fitting the tank bags with Tanklock system	
 KN226	Specific engine guard <i>we recommend fitting by a qualified mechanic / chromed</i>	
TRIUMPH	Street Triple 675 (13 > 14)	
 BF02K	Specific flange for fitting the tank bags with Tanklock system	
 TE6405K	Specific holder for soft side bags	



↘ = Item available until it runs out of stock

CODE	DESCRIPTION	PRICE
KA6405	Specific screen, black 28,5 x 36 cm (H x W) <i>Complete with fitting kit</i>	

TRIUMPH Tiger 800 / Tiger 800 XC (11 > 14)

KR6401	Specific rear rack for MONOKEY ® top case <i>maximum load allowed 6 kg / MONOKEY® plate included / it is necessary to puncture the housing behind the saddle</i>	
KRA6401	Specific rear rack in aluminium for MONOKEY ® top case <i>maximum load allowed 6kg / it does not allow the assembly of the stop light kit or the remote control device on the case / you must puncture the housing in arranged sections</i>	

KLR6401	Specific rapid release side case holder for MONOKEY ® cases	
----------------	--------------------------------------------------------------------	--

BF02K	Specific flange for fitting the tank bags with Tanklock system	
--------------	----------------------------------------------------------------	--

6401DT	↘ Specific screen, transparent 53 x 46,5 cm (H x W) <i>to be combined with the specific D6401KIT fitting kit/ 17 cm higher than original</i>	
---------------	-------------------------------------------------------------------------------------------------------------------------------------------------	--

D6401KIT	↘ Specific fitting kit for 6401DT	
-----------------	-----------------------------------	--

KAF6401	Specific Airstream sliding wind-screen transparent. Maximum height 60,5 cm (12 cm of extension), width 45,5 cm <i>complete with specific fitting kit / to be mounted instead of the original screen</i>	
----------------	------------------------------------------------------------------------------------------------------------------------------------------------------------------------------------------------------------	--

EH6401K	Plexiglass extension for original hand protectors, smoked	
----------------	-----------------------------------------------------------	--

KN6401	Specific engine guard <i>we recommend fitting by a qualified mechanic / black colour /only for Tiger 800 - Tiger 800.XC (11)</i>	
---------------	-------------------------------------------------------------------------------------------------------------------------------------	--

KN6401A	Specific engine guard <i>only for '12-'13 version / we recommend fitting by a qualified mechanic / black colour</i>	
----------------	------------------------------------------------------------------------------------------------------------------------	--

TN6401AKIT	Specific kit to install the KN6401 on Tiger 800/Tiger 800XC (2011)	
-------------------	--------------------------------------------------------------------	--

RP6401	Oil carter protector in Aluminium	
---------------	-----------------------------------	--

VARIOUS ACCESSORIES ES6401K	Specific support in aluminum and stainless steel to widen the surface support area of the original side stand <i>it is not compatible with central tripod</i>	
-------------------------------------------	------------------------------------------------------------------------------------------------------------------------------------------------------------------	--

01SKIT	Specific kit to mounting the KS900A Smart Bar	
---------------	-----------------------------------------------	--

KMG6401	Mudguard/specific ABS chain-cover, black colour	
----------------	-------------------------------------------------	--

TRIUMPH Bonneville 865

KR2260	Specific rear chromed rack for MONOLOCK ® or MONOKEY ® top case <i>to be combined with the K636 MONOKEY® plate, or with the plate already included in the MONOLOCK® top cases</i>	
---------------	----------------------------------------------------------------------------------------------------------------------------------------------------------------------------------------------------	--

TRIUMPH ST 1050 Sprint (05 > 11)

KZ726	Specific rear rack for MONOKEY ® or MONOLOCK ® top case <i>to be combined with the MONOKEY® KM5 or KM7 plates, or with the MONOLOCK® KM5M or KM6M plates / maximum load allowed 6 kg</i>	
--------------	-----------------------------------------------------------------------------------------------------------------------------------------------------------------------------------------------------------	--

BF02K	Specific flange for fitting the tank bags with Tanklock system	
--------------	----------------------------------------------------------------	--

TRIUMPH Tiger 1050 (07 > 12)

KR225	Specific rear rack for MONOKEY ® top case MONOKEY ® plate included / maximum load allowed 6 Kg / it is not compatible with the original sidecase holder	
--------------	--------------------------------------------------------------------------------------------------------------------------------------------------------------------------	--

KL727	Specific pannier holder for MONOKEY ® side cases <i>it can be mounted only with the specific rear rack KR225</i>	
--------------	----------------------------------------------------------------------------------------------------------------------------	--

T704K	↘ Specific holder for soft side bags <i>it can be mounted without the specific rear rack KR225 using the T700KIT</i>	
--------------	-------------------------------------------------------------------------------------------------------------------------	--

















T700KIT	↘ Specific kit to install the T704K without the specific rear rack KR225	
----------------	--------------------------------------------------------------------------	--

BF02K	Specific flange for fitting the tank bags with Tanklock system	
--------------	----------------------------------------------------------------	--

KD225ST	Specific screen, transparent 50,5 x 49,3 cm (H x W) <i>12,5 cm higher than the original</i>	
----------------	------------------------------------------------------------------------------------------------	--













KN225	Specific engine guard <i>we recommend fitting by a qualified mechanic</i>	
--------------	------------------------------------------------------------------------------	--

MOTORCYCLE ACCESSORIES















CODE	DESCRIPTION	PRICE
TRIUMPH Tiger Sport 1050 (13 > 14)		
 KR6404	Specific rear rack for MONOKEY ® top case MONOKEY ® plate included / it is not compatible with the original sidecase holder	
KRA6404	Specific rear rack in aluminium for MONOKEY ® top case maximum load allowed 6kg / it does not allow the assembly of the stop light kit or the remote control device on the case / it is not compatible with the original sidecase holder	
 KLR6404	Specific rapid release side case holder for MONOKEY ® cases it can be mounted without the specific rear rack KR6404 or KRA6404 using the 6404KIT	
6404KIT	Specific kit to install the KLR6404 without the specific rear rack KR6404 o KRA6404	
 BF02K	Specific flange for fitting the tank bags with Tanklock system	
 KD225ST	Specific screen, transparent 50,5 x 49,3 cm (H x W) 12,5 cm higher than the original	
KAF6404	Specific Airstream sliding wind-screen transparent. Maximum height 59 cm (12 cm of excursion) width 59.5 complete with specific fitting kit / to be mounted instead of the original screen	
 KN6404	Specific engine guard we recommend fitting by a qualified mechanic / black colour	
VARIOUS ACCESSORIES 01SKIT	Specific kit to mounting the KS900A Smart Bar	
TRIUMPH Speed Triple 1050 (08 > 10)		
 T702K	↘ Specific holder for soft side bags for models from '08	
 BF02K	Specific flange for fitting the tank bags with Tanklock system	
TRIUMPH Speed Triple 1050 (11 > 14)		
 TE6402K	Specific holder for soft side bags	
 BF02K	Specific flange for fitting the tank bags with Tanklock system	
TRIUMPH Sprint GT 1050 (10 > 14)		
 KRA227	Specific rear rack in aluminium for MONOKEY ® top case, black it can be fitted with the original side-case / maximum load allowed 6kg / it does not allow the assembly of the stop light kit or the remote control device on the case	
 BF02K	Specific flange for fitting the tank bags with Tanklock system	
 KD6400S	↘ Specific screen, smoked 49,5 x 38,5 cm (H x W)	
TRIUMPH Tiger Explorer 1200 (12 > 14)		
 KR6403	Specific rear rack for MONOKEY ® top case MONOKEY ® plate included	
KRA6403	Specific rear rack in aluminium for MONOKEY ® top case maximum load allowed 6kg / it does not allow the assembly of the stop light kit or the remote control device on the case	
 KLR6403	Specific rapid release side case holder for MONOKEY ® cases	
 BF02K	Specific flange for fitting the tank bags with Tanklock system	
 KD6403ST	↘ Specific screen, transparent 51 x 45 cm (H x W) 5 cm higher than the original	
KAF6403	Specific Airstream sliding wind-screen transparent. Maximum height 60,5 cm (12 cm of extension), width 45,5 cm complete with specific fitting kit / to be mounted instead of the original screen	
 KN6403	Specific engine guard we recommend fitting by a qualified mechanic / black colour	
RP6403	Oil carter protector in Aluminium	
VARIOUS ACCESSORIES ES6403K	Specific support in aluminum and stainless steel to widen the surface support area of the original side stand	
01SKIT	Specific kit to mounting the KS900A Smart Bar	



↘ = Item available until it runs out of stock

CODE	DESCRIPTION	PRICE
YAMAHA		
YAMAHA Aerox R 50 (13 > 14)		
 KR2113	Specific rear rack for MONOLOCK ® top case <i>to be combined with the plate already included in the MONOLOCK® top case</i>	
 288A	Specific screen, transparent 56 x 71,5 cm (H x W) <i>to be combined with the specific A2113A fitting kit</i>	
A2113A	Specific fitting kit, black for 288A	
YAMAHA BW'S 50 (05 > 14)		
 KR3560	Specific rear rack for MONOLOCK ® top case <i>it is necessary to remove the original grab handle / to be combined with the plate already included in the MONOLOCK® top case</i>	
YAMAHA Neo's 50 (08 > 14)		
 KR366	Specific rear rack for MONOLOCK ® top case <i>to be combined with the plate already included in the MONOLOCK® top case</i>	
 128A	Specific screen, transparent 74 x 67 cm (H x W) <i>to be combined with the specific A285A fitting kit/ 8 cm higher than 105A</i>	
105A	Specific screen, transparent 66 x 67 cm (H x W) <i>to be combined with the specific A285A fitting kit/ With hand protectors</i>	
A285A	Specific fitting kit for 105A and 128A	
YAMAHA Neo's 50-100 (97 > 02)		
 KR86	Specific rear rack for MONOLOCK ® top case <i>to be combined with the plate already included in the MONOLOCK® top case</i>	
YAMAHA D'elight 114 (13 > 14) NEW		
 KR2114	Specific rear rack for MONOLOCK ® top case <i>to be combined with the plate already included in the MONOLOCK® top case</i>	
 2114A	Specific screen, transparent, 40 x 72 cm (H x W) <i>to be combined with the specific A2114A fitting kit</i>	
A2114A	Specific fitting kit for 2114A	
YAMAHA BW'S 125 (10 > 14)		
 KR372	Specific rear rack for MONOLOCK ® top case <i>to be combined with the plate already included in the MONOLOCK® top case / you must remove the grab rails, they are replaced by the rack itself</i>	
 288A	Specific screen, transparent 56 x 71,5 cm (H x W) <i>to be combined with the specific A288A fitting kit</i>	
A288A	Specific fitting kit, black for 288A	
YAMAHA Cignus X 125 (04 > 06)		
 KR354	Specific rear rack for MONOLOCK ® top case <i>to be combined with the plate already included in the MONOLOCK® top case</i>	
 102A	Specific screen, transparent 66 x 68 cm (H x W) <i>to be combined with the specific A280A fitting kit/ With hand protectors / purchasable only if already in possession of the article A280A</i>	
128A	Specific screen, transparent 74 x 67 cm (H x W) <i>to be combined with the specific A280A fitting kit/ 8 cm higher than 105A / / purchasable only if already in possession of the article A280A</i>	
YAMAHA Cignus X 125 (07 > 14)		
 KR354	Specific rear rack for MONOLOCK ® top case <i>to be combined with the plate already included in the MONOLOCK® top case</i>	
 102A	Specific screen, transparent 66 x 68 cm (H x W) <i>to be combined with the specific A283A fitting kit</i>	
128A	Specific screen, transparent 74 x 67 cm (H x W) <i>to be combined with the specific A283A fitting kit/ 8 cm higher than 105A</i>	
A283A	Specific fitting kit for 102A and 128A	

MOTORCYCLE ACCESSORIES











YAMAHA	CODE	DESCRIPTION	PRICE
YAMAHA MAJESTY S 125 (14) NEW			
	KR2121	Specific rear rack for MONOLOCK ® top case <i>to be combined with the plate already included in the MONOLOCK® top case</i>	
YAMAHA TRICITY 125 (14) NEW			
	KR2120	Specific rear rack for MONOLOCK ® top case <i>to be combined with the plate already included in the MONOLOCK® top case or KM6M</i>	
YAMAHA Vity 125 (10 > 14)			
	KR373	Specific rear rack for MONOLOCK ® top case <i>to be combined with the plate already included in the MONOLOCK® top case</i>	
	288A	Specific screen, transparent 56 x 71,5 cm (H x W) <i>to be combined with the specific A289A fitting kit</i>	
	A289A	Specific fitting kit for 288A <i>Black colour</i>	
YAMAHA XT 125 R/X (05 > 12)			
	KE3320	Specific rear rack for MONOLOCK ® top case <i>to be combined with the plate already included in the MONOLOCK® top case</i>	
YAMAHA YBR 125 (10 > 14)			
	KR2104	Specific rear rack for MONOLOCK ® top case <i>to be combined with the plate already included in the MONOLOCK® top case</i>	
	KL2104	Specific pannier holder for MONOKEY ® side cases <i>you can only mount cases MONOKEY® K21</i>	
YAMAHA Majesty 125-150 (99 > 00)			
	KR43	↘ Specific rear rack for MONOLOCK ® or MONOKEY ® top case <i>to be combined with the K636 MONOKEY® plate, or with the plate already included in the MONOLOCK® top cases</i>	
YAMAHA Majesty 125-150-180 (01 > 11)			
	KR46	Specific rear rack for MONOKEY ® top case MONOKEY ® plate included	
	KR460	Specific rear rack for MONOLOCK ® top case MONOLOCK ® plate included	
	130DT	Specific screen, transparent 69,2 x 68,2 cm (H x W) <i>to be combined with the specific D130KIT fitting kit</i>	
	D130KIT	Specific fitting kit for 130DT	
YAMAHA X-CITY 125-250 (07 > 14)			
	KR361	↘ Specific rear rack for MONOLOCK ® top case <i>to be combined with the plate already included in the MONOLOCK® top case</i>	
	KD439ST	Specific screen, transparent with serigraphy 71 x 77 cm (H x W) <i>to be mounted instead of the original screen / 22 cm higher than the original</i>	
YAMAHA X-MAX 125-250 (05 > 09)			
	KR355	Specific rear rack for MONOKEY ® top case <i>you must puncture the housing behind the saddle in arranged sections / MONOKEY® plate included</i>	
	KR3550	Specific rear rack for MONOLOCK ® top case <i>you must puncture the housing behind the saddle in arranged sections / to be combined with the plate already included in the MONOLOCK® top case</i>	
	KD438ST	Specific screen, transparent 63,5 x 69,5 cm (H x W) <i>to be mounted instead of the original screen / 25,5 cm higher than original</i>	
VARIOUS ACCESSORIES	KTB49	Specific backrest <i>It cannot be mounted if rack and case are installed</i>	
YAMAHA X-MAX 125-250 (10 > 13)			
	KR370	Specific rear rack for MONOKEY ® top case <i>maximum load allowed 6 kg / MONOKEY® plate included / it is necessary to puncture the housing behind the saddle</i>	
	KR3700	Specific rear rack for MONOLOCK ® top case <i>it is necessary to puncture the housing behind the saddle / to be combined with the plate already included in the MONOLOCK® top case</i>	



↘ = Item available until it runs out of stock

CODE	DESCRIPTION	PRICE
446DT	Specific screen, transparent 73,5 x 63 cm (H x W) <i>to be combined with the specific D446KIT fitting kit/ 30 cm higher than original</i>	
D446KIT	Specific fitting kit for 446DT	
KAF446	Specific Airstream sliding wind-screen, transparent, complete with fitting kit. Maximum height 70 cm (12 cm of extension), width 62 cm <i>complete with specific fitting kit / to be mounted instead of the original screen</i>	
KD446B	Specific low and sports screen gloss black 37 x 43 cm (H x W)	
VARIOUS ACCESSORIES KTB55	Specific backrest <i>It cannot be mounted if rack and case are installed</i>	
YAMAHA X-MAX 125-250 (14) NEW		
KR2117	Specific rear rack for MONOKEY ® top case <i>maximum load allowed 6 kg / MONOKEY® plate included</i>	
KR2117M	Specific rear rack for MONOLOCK ® top case <i>to be combined with the plate already included in the MONOLOCK® top case</i>	
2111DT	Specific screen, transparent 73 x 59 cm (H x W) <i>to be combined with the specific D2111KIT fitting kit</i>	
D2111KIT	Specific fitting kit for 2111DT	
VARIOUS ACCESSORIES KTB2111	Specific backrest <i>it cannot be mounted if rack and case are installed</i>	
YAMAHA Xenter 125-150 (12 > 14)		
KR2102	Specific rear rack for MONOLOCK ® or MONOKEY ® top case <i>to be combined with the K636 MONOKEY® plate, or with the plate already included in the MONOLOCK® top cases / maximum load allowed 6 kg</i>	
KD2102ST	Specific screen, transparent 65 x 70 cm (H x W) <i>to be mounted instead of the original screen / 14 cm higher than the original wind-screen</i>	
A2102A	Specific fitting kit for KD2102ST, black colour <i>only with KD2102ST for Xenter scooters supplied without the original screen</i>	
YAMAHA Majesty 250 (96 > 99)		
KD115ST	Specific screen, transparent 73 x 79 cm (H x W) <i>to be mounted instead of the original screen</i>	
YAMAHA Majesty 250 (00 > 07)		
KD127ST	Specific screen, transparent 80 x 70,7 cm (H x W) <i>to be mounted instead of the original screen / Without moulding steel / without air intake</i>	
YAMAHA XC 300 Versity (03 > 07)		
KD432ST	Specific screen, transparent 72 x 75 cm (H x W) <i>to be mounted instead of the original screen / 22 cm higher than the original</i>	
YAMAHA Majesty 400 (04 > 08)		
K331	Specific rear rack for MONOKEY ® top case <i>MONOKEY® plate included</i>	
K331M	Specific rear rack for MONOLOCK ® top case <i>MONOLOCK® plate included</i>	
KD137ST	Specific screen, transparent 74 x 64 cm (H x W) <i>to be mounted instead of the original screen / 4 cm higher than the original</i>	
VARIOUS ACCESSORIES KTB47	↘ Specific backrest <i>it can be mounted only if K331 or K331M are installed</i>	
KTB48	↘ Specific backrest <i>it cannot be mounted if rack and case are installed / compatible from '04 to '06</i>	
YAMAHA Majesty 400 (09 > 14)		
K331	Specific rear rack for MONOKEY ® top case <i>MONOKEY® plate included</i>	
K331M	Specific rear rack for MONOLOCK ® top case <i>MONOLOCK® plate included</i>	
445DT	Specific screen, transparent 86 x 66 cm (H x W) <i>to be combined with the specific D445KIT fitting kit/ 22,5 cm higher than original</i>	

MOTORCYCLE ACCESSORIES

CODE	DESCRIPTION	PRICE
D445KIT	Specific fitting kit for 445DT	
VARIOUS ACCESSORIES KTB47	↘ Specific backrest it can be mounted only if K331 or K331M are installed	
KTB48	↘ Specific backrest it can be mounted only if K331 or K331M are installed / compatible from '04 to '06	
YAMAHA	X-MAX 400 (13 > 14)	
 KR2111	Specific rear rack for MONOKEY ® top case maximum load allowed 6 kg / MONOKEY ® plate included	
KR2111M	Specific rear rack for MONOLOCK ® top case to be combined with the plate already included in the MONOLOCK ® top case	
 2111DT	Specific screen, transparent 73 x 59 cm (H x W) to be combined with the specific D2111KIT fitting kit	
D2111KIT	Specific fitting kit for 2111DT	
VARIOUS ACCESSORIES KTB2111	Specific backrest it cannot be mounted if rack and case are installed	
YAMAHA	T-MAX 500 (01 > 07)	
 KR45	Specific rear rack for MONOKEY ® top case MONOKEY ® plate included / it is necessary to puncture the housing behind the saddle	
 TK272	Specific holder for soft side bags	
 KD128ST	Specific screen, transparent 80,1 x 64,5 cm (H x W) to be mounted instead of the original screen	
KD128B	Specific low and sports screen gloss black 52 x 44,5 cm (H x W)	
VARIOUS ACCESSORIES KTB45	Specific backrest	
KTB51	Specific backrest it cannot be mounted if KR45 is installed	
YAMAHA	T-MAX 500 (08 > 11)	
 KR2013	Specific rear rack for MONOKEY ® top case MONOKEY ® plate included / maximum load allowed 6 Kg / it is necessary to puncture the housing behind the saddle	
KR2013M	Specific rear rack for MONOLOCK ® top case MONOLOCK ® plate included / it is necessary to puncture the housing behind the saddle	
KR364	Specific rear rack for MONOKEY ® top case maximum load allowed 6 kg / MONOKEY ® plate included / it is necessary to puncture the housing behind the saddle	
KR364M	Specific rear rack for MONOLOCK ® top case MONOLOCK ® plate included / it is necessary to puncture the housing behind the saddle	
 TK2013K	Specific holder for soft side bags it is not compatible with the specific rear rack KR2013 / KR2013M	
 KD442ST	Specific screen, transparent 50 x 57 cm (H x W) to be mounted instead of the original screen / 16 cm higher than the original wind-screen	
KD442B	Specific low and sports screen gloss black 59 x 45 cm (H x W) to be mounted instead of the original screen / In case you wish remove the mirrors from their mounts, use the two rubber stoppers to close the holes	
KAF442	↘ Specific Airstream sliding wind-screen transparent. Maximum height 90 cm (12 cm of extension) width 58 cm complete with specific fitting kit / to be mounted instead of the original screen	
VARIOUS ACCESSORIES KTB2013	Specific backrest it cannot be mounted if rack and case are installed	
YAMAHA	T-MAX 530 (12 > 14)	
 KR2013	Specific rear rack for MONOKEY ® top case MONOKEY ® plate included / maximum load allowed 6 Kg / it is necessary to puncture the housing behind the saddle	
KR2013M	Specific rear rack for MONOLOCK ® top case MONOLOCK ® plate included / it is necessary to puncture the housing behind the saddle	
 TK2013K	Specific holder for soft side bags it is not compatible with the specific rear rack KR2013 / KR2013M	
 KD2013ST	Specific screen, transparent 65 x 61 cm (H x W) to be mounted instead of the original screen	
KD2013B	Specific low and sports screen gloss black 46 x 48 cm (H x W) to be mounted instead of the original screen	



↘ = Item available until it runs out of stock

















CODE	DESCRIPTION	PRICE
KD2013B0	Specific screen sports and low, gloss and matt black 46 x 48 cm (H x W) <i>to be mounted instead of the original screen</i>	
VARIOUS ACCESSORIES KTB2013	Specific backrest <i>it cannot be mounted if rack and case are installed</i>	
YAMAHA FZS 600 Fazer (98 > 03)		
 K3400	Specific rear rack for MONOKEY ® or MONOLOCK ® top case <i>To be combined with the plate MONOKEY® K553N, or with the plate MONOLOCK® MKN</i>	
YAMAHA FZ6/FZ6 600 Fazer (04 > 06)		
 KZ351	Specific rear rack for MONOKEY ® or MONOLOCK ® top case <i>to be combined with the MONOKEY® KM5 or KM7 plates, or with the MONOLOCK® KMSM or KM6M plates</i>	
 KL351	Specific pannier holder for MONOKEY ® side cases <i>it can be mounted without the specific rear rack KZ351 using the 351KIT / the indicators must be moved from original position</i>	
KLX351	Specific pannier holder for K33 MONOKEY ® SIDE cases <i>it can be mounted only with the specific rear rack KZ351 / you must move the indicators from their original position</i>	
 TK351	Specific holder for soft side bags <i>it can be mounted without the specific rear rack KZ351 using the 351KIT</i>	
 351KIT	Specific kit to install the KL351, KLX351 and TK351 without the specific rear rack	
 BF05K	Specific flange for fitting the tank bags with Tanklock system	
 KD136ST	Specific screen, transparent 61 x 53,5 cm (H x W) <i>12,5 cm higher than the original / made for FZ6 fazer</i>	
140D	Specific screen, smoked 35 x 36cm (H x W) <i>to be combined with the specific D140KIT fitting kit/ only for FZ6</i>	
D140KIT	Specific fitting kit for 140D <i>only for FZ6</i>	
 KN358	Specific engine guard <i>we recommend fitting by a qualified mechanic / It can be installed also on versions having the original central stand / black colour</i>	
YAMAHA FZ6 S2 / FZ6 600 Fazer S2 (07 > 11)		
 KZ351	Specific rear rack for MONOKEY ® or MONOLOCK ® top case <i>to be combined with the MONOKEY® KM5 or KM7 plates, or with the MONOLOCK® KMSM or KM6M plates</i>	
 KL360	Specific pannier holder for MONOKEY ® side cases <i>it can be mounted without the specific rear rack KZ351 using the 351KIT / the indicators must be moved from original position</i>	
KLX360	Specific pannier holder for K33 MONOKEY ® SIDE cases <i>it can be mounted without the specific rear rack KZ351 using the 351KIT / you must move the indicators from their original position</i>	
351KIT	Specific kit to install the KL360 and TE351K without the specific rear rack	
 TE351K	Specific holder for soft side bags <i>it can be mounted without the specific rear rack KZ351 using the 351KIT</i>	
 BF05K	Specific flange for fitting the tank bags with Tanklock system	
440D	Specific screen, transparent 57 x 57 cm (H x W) <i>19 cm higher than the original / for FZ6 Fazer S2</i>	
 D440KIT	Specific fitting kit for 440D <i>for FZ6 Fazer S2</i>	
246N902K	Universal screen, smoked 38 x 33,5 cm (H x W) <i>to be combined with the specific A284A fitting kit/ for FZ6 Fazer S2 / With black bottom frame / the inside is painted in matt colour to prevent the front light from reflecting</i>	
 KN358	Specific engine guard <i>we recommend fitting by a qualified mechanic / It can be installed also on versions having the original central stand / black colour</i>	
YAMAHA XJ 600 Diversion (91 > 95)		
 K3250	Specific rear rack for MONOKEY ® or MONOLOCK ® top case <i>To be combined with the plate MONOKEY® K553N, or with the plate MONOLOCK® MKN</i>	
YAMAHA XJ 600 Diversion (96 > 03)		
 K3250	Specific rear rack for MONOKEY ® or MONOLOCK ® top case <i>To be combined with the plate MONOKEY® K553N, or with the plate MONOLOCK® MKN</i>	
 KD116S	Specific screen, smoked 46 x 33,5 cm (H x W) <i>Made only for version S</i>	

MOTORCYCLE ACCESSORIES

CODE	DESCRIPTION	PRICE
YAMAHA XJ 600 Diversion N (96 > 99)		
 K3250	Specific rear rack for MONOKEY ® or MONOLOCK ® top case <i>To be combined with the plate MONOKEY® K553N, or with the plate MONOLOCK® MKN</i>	
YAMAHA XJ6 (09 > 12) / XJ6 Diversion / XJ6 Diversion F 600 (09 > 13)		
 KZ364	Specific rear rack for MONOKEY ® or MONOLOCK ® top case <i>to be combined with the MONOKEY® KM5 or KM7 plates, or with the MONOLOCK® KM5M or KM6M plates</i>	
 KLXR364	Specific rapid release side case holder for K33 MONOKEY ® SIDE cases	
 TE2110K	Specific holder for soft side bags <i>it can be mounted without the specific rear rack KZ364 using the 2110KIT</i>	
 BF05K	Specific flange for fitting the tank bags with Tanklock system	
 KD444S	↘ Specific screen, smoked 42.5 x 38 cm (H x W) <i>Only for XJ6 Diversion / 10 cm higher than the original</i>	
 KD449S	Specific screen, smoked, 50 x 38 cm (H x W) <i>Only for XJ6 Diversion F / 19,5 cm higher than the original</i>	
VARIOUS ACCESSORIES 055KIT	Specific kit to mounting the KS900A Smart Bar	
YAMAHA XJ6 600 (13)		
 KZ364	Specific rear rack for MONOKEY ® or MONOLOCK ® top case <i>to be combined with the MONOKEY® KM5 or KM7 plates, or with the MONOLOCK® KM5M or KM6M plates</i>	
 KLXR2110	Specific rapid release side case holder for K33 MONOKEY ® SIDE cases <i>you must remove the grabrails, they are reproduced by the side case holder itself</i>	
 BF05K	Specific flange for fitting the tank bags with Tanklock system	
 TE2110K	Specific holder for soft side bags <i>it can be mounted without the specific rear rack KZ364 using the 2110KIT</i>	
2110KIT	Specific kit to install the TE2110K without the specific rear rack KZ364	
VARIOUS ACCESSORIES 055KIT	Specific kit to mounting the KS900A Smart Bar	
YAMAHA XT 600 E (95 > 02)		
 K3330	Specific rear rack for MONOKEY ® or MONOLOCK ® top case <i>To be combined with the plate MONOKEY® K553N, or with the plate MONOLOCK® MKN</i>	
YAMAHA MT-03 (06 > 14)		
 KZ356	Specific rear rack for MONOKEY ® or MONOLOCK ® top case <i>to be combined with the MONOKEY® KM5 or KM7 plates, or with the MONOLOCK® KM5M or KM6M plates / maximum load allowed 6 Kg / with integrated passenger grabrails</i>	
 TK129	Specific holder for soft side bags	
 BF05K	Specific flange for fitting the tank bags with Tanklock system	
 245A	Universal screen, smoked 33,5 x 29 cm (H x W) <i>to be combined with the specific A281A fitting kit</i>	
245N	Universal screen, black 33,5 x 29 cm (H x W) <i>to be combined with the specific A281A fitting kit/ The inside is painted in matt colour to prevent the front light from reflecting</i>	
 246N902K	↘ Universal screen, smoked 38 x 33,5 cm (H x W) <i>to be combined with the specific A281A fitting kit/ With black bottom frame / the inside is painted in matt colour to prevent the front light from reflecting</i>	
A281A	Specific fitting kit for 245A, 245N, 246___	
 KN356	↘ Specific engine guard <i>we recommend fitting by a qualified mechanic</i>	
YAMAHA YZF 600 Thunder Cat (96 > 02)		
 K3380	Specific rear rack for MONOKEY ® or MONOLOCK ® top case <i>To be combined with the plate MONOKEY® K553N, or with the plate MONOLOCK® MKN</i>	
YAMAHA YZF 600 R6 (06 > 07)		
 BF05K	Specific flange for fitting the tank bags with Tanklock system	



↘ = Item available until it runs out of stock



















CODE	DESCRIPTION	PRICE
YAMAHA XVS 650 Drag Star (97 > 02)		
 A35N	Universal screen, 54,9 x 46,8 cm (H x W) <i>High and shaded bottom version</i>	
23A	Universal screen, 38,8 x 41 cm (H x W)	
AS100A2	Specific fitting kit for 23A and A35N	
YAMAHA XVS 650A Drag Star Classic (98 > 07)		
 A39	Universal screen, transparent 51,7 x 57,3 cm (H x W) <i>to be combined with the specific AS102A2 fitting kit/ High version</i>	
AS102A2	Specific fitting kit for A39	
YAMAHA XT 660 R / XT 660 X (04 > 06)		
 KR353M	Specific rear rack for MONOLOCK ® top case MONOLOCK ® plate included	
 KD433S	Specific screen, smoked 37 x 36,5 cm (H x W) <i>Only for XT 660 R version</i>	
YAMAHA XT 660 R / XT 660 X (07 > 14)		
 KR365M	Specific rear rack for MONOLOCK ® top case MONOLOCK ® plate included	
KD433S	Specific screen, fumè 37 x 36,5 cm (H x W) <i>only for XT 660 R version</i>	
 KN359	Specific engine guard <i>we recommend fitting by a qualified mechanic</i>	
YAMAHA XT 660Z Teneré (08 > 14)		
 K333	Specific rear rack for MONOKEY ® top case MONOKEY ® plate included	
K333M	Specific rear rack for MONOLOCK ® top case MONOLOCK ® plate included	
 KLXR363	↘ Specific rapid release side case holder for K33 MONOKEY ® SIDE cases	
KL363	Specific pannier holder for MONOKEY ® side cases	
 KD443ST	Specific screen, transparent 40 x 42 cm (H x W) <i>10 cm higher than the original</i>	
 KN348	↘ Specific engine guard <i>we recommend fitting by a qualified mechanic / black colour</i>	
KN2105	Specific engine guard <i>we recommend fitting by a qualified mechanic / black colour</i>	
RP2105	Oil carter protector in Aluminium	
VARIOUS ACCESSORIES ES2105K	Specific support in aluminum and stainless steel to widen the surface support area of the original side stand	
YAMAHA MT-07 700 (14) NEW		
 KZ2118	Specific rear rack for MONOKEY ® or MONOLOCK ® top case <i>to be combined with the MONOKEY® KM5 or KM7 plates, or with the MONOLOCK® KM5M or KM6M plates / you have to puncture the housing under the tail</i>	
 KLX2118	Specific pannier holder for K33 MONOKEY ® SIDE cases <i>it can be mounted only with the specific rear rack KZ2118</i>	
 BF21K	Specific flange for fitting the tank bags with Tanklock system	
 TE2118K	Specific holder for soft side bags <i>it can be mounted without the specific rear rack KZ2118 using the 2118KIT</i>	
 2118KIT	Specific kit to install the TE2118K without the specific rear rack KZ2118	
 KA2118	Specific screen, black 28,5 x 36 cm (H x W) <i>Complete with fitting kit</i>	
VARIOUS ACCESSORIES KHP2115	Hand protector specific ABS	

MOTORCYCLE ACCESSORIES















CODE	DESCRIPTION	PRICE
YAMAHA XV 750 Virago (89 > 98)		
 A35N	specific screen, transparent 54,9 x 46,8 cm (H x W) <i>compatible from '92 to '98 / high and shaded bottom version</i>	
23A	Specific screen, transparent 38,8 x 41 cm (H x W) <i>compatible from '92 to '98 / low, transparent version</i>	
 AS100A2	Specific fitting kit for 23A and A35N	
YAMAHA FZ8 / Fazer 8 800 (10 > 13)		
 KZ366	Specific rear rack for MONOKEY ® or MONOLOCK ® top case <i>to be combined with the MONOKEY® KM5 or KM7 plates, or with the MONOLOCK® KM5M or KM6M plates / maximum load allowed 6 kg</i>	
 KLXR366	Specific rapid release side case holder for K33 MONOKEY ® SIDE cases <i>it can be mounted without the specific rear rack KZ366 using the 366KIT / you must move the indicators from their original position</i>	
366KIT	Specific kit to install the KLXR366 and TE366K without the specific rear rack	
 TE366K	Specific holder for soft side bags <i>it can be mounted without the specific rear rack KZ366 using the 366KIT</i>	
 BF05K	Specific flange for fitting the tank bags with Tanklock system	
 KA287N	↘ Specific screen, gloss black 28 x 30 cm (H x W)	
KD448S	↘ Specific screen, smoked 55,5 x 55,5 cm (H x W) <i>19 cm higher than original / only for FZ8</i>	
 KN352	Paramotore tubolare specifico, nero <i>si raccomanda di fare eseguire il montaggio ad un meccanico qualificato</i>	
VARIOUS ACCESSORIES 055KIT	Specific kit to mounting the KS900A Smart Bar	
YAMAHA TDM 850 (96 > 01)		
 K3360	Specific rear rack for MONOKEY ® or MONOLOCK ® top case <i>To be combined with the plate MONOKEY® K553N, or with the plate MONOLOCK® MKN</i>	
 KD116S	Specific screen, smoked 46 x 33,5 cm (H x W) <i>Made only for version S</i>	
YAMAHA MT-09 900 (13 > 14) NEW		
 KZ2115	Specific rear rack for MONOKEY ® or MONOLOCK ® top case <i>to be combined with the MONOKEY® KM5 or KM7 plates, or with the MONOLOCK® KM5M or KM6M plates / maximum load allowed 6 kg</i>	
 TE2115K	Specific holder for soft side bags	
2115KIT	Specific kit to install the TE2115K without the specific rear rack KZ2115	
 BF05K	Specific flange for fitting the tank bags with Tanklock system	
 KA2115	Specific screen, smoked 28.5 x 36 cm (H x W) <i>Complete with fitting kit</i>	
VARIOUS ACCESSORIES KHP2115	Hand protector specific ABS	
015KIT	Specific kit to mounting the KS900A Smart Bar	
YAMAHA TDM 900 (02 > 14)		
 K3470	Specific rear rack for MONOKEY ® or MONOLOCK ® top case <i>To be combined with the plate MONOKEY® K553N, or with the plate MONOLOCK® MKN/ maximum load allowed 6 kg</i>	
KR347	Specific rear rack for MONOLOCK ® or MONOKEY ® top case <i>to be combined with the K636 MONOKEY® plate, or with the plate already included in the MONOLOCK® top cases / maximum load allowed 5 kg</i>	
 KL347	Specific pannier holder for MONOKEY ® side cases	
KLX347	Specific pannier holder for K33 MONOKEY ® SIDE cases <i>you must move the indicators from their original position</i>	
 BF05K	Specific flange for fitting the tank bags with Tanklock system	
 KD132S	Specific screen, smoked 41 x 32,5 cm (H x W) <i>With spoiler</i>	



↘ = Item available until it runs out of stock















CODE	DESCRIPTION	PRICE
 KN34	Specific engine guard <i>we recommend fitting by a qualified mechanic / colour black</i>	
VARIOUS ACCESSORIES 05SKIT	Specific kit to mounting the KS900A Smart Bar	
YAMAHA XJ 900 Diversion (94 > 05)		
 K3310	Specific rear rack for MONOKEY ® or MONOLOCK ® top case <i>To be combined with the plate MONOKEY® K553N, or with the plate MONOLOCK® MKN</i>	
 K8215	Specific wingrack fitting kit	
YAMAHA XVS 950 A Midnight Star (09 > 14)		
 TK276	Specific holder for soft side bags	
 A47	Specific screen, transparent 56 x 57 cm (H x W) <i>to be combined with the specific AS103A2 fitting kit</i>	
AS103A2	Specific fitting kit for A46, A47	
YAMAHA FZ1 1000 (06 > 14)		
 KZ365	Specific rear rack for MONOLOCK ® top case <i>we recommend mounting smaller cases MONOLOCK® in conjunction with KMSM or KM6M plates / it requires fitment of cases up to 35 ltr / maximum load allowed 6 kg / You have to puncture the housing under the tail in arranged sections</i>	
 KLX359	Specific pannier holder for K33 MONOKEY ® SIDE cases <i>it can be mounted without the specific rear rack KZ359 using the 365KIT / you must move the indicators from their original position</i>	
KLXR359	Specific rapid release side case holder for K33 MONOKEY ® SIDE cases <i>it can be mounted without the specific rear rack KZ359 using the 365KIT / you must move the indicators from their original position</i>	
365KIT	Specific kit to install the KLX and the KLXR without the specific rear rack	
 TK271	Specific holder for soft side bags <i>it is not compatible with the specific rear rack KZ365</i>	
 BF05K	Specific flange for fitting the tank bags with Tanklock system	
YAMAHA FZS 1000 Fazer (01 > 02)		
 KZ348	Specific rear rack for MONOKEY ® or MONOLOCK ® top case <i>to be combined with the MONOKEY® KMS or KM7 plates, or with the MONOLOCK® KMSM or KM6M plates</i>	
YAMAHA FZS 1000 Fazer (03 > 05)		
 KZ348	Specific rear rack for MONOKEY ® or MONOLOCK ® top case <i>to be combined with the MONOKEY® KMS or KM7 plates, or with the MONOLOCK® KMSM or KM6M plates</i>	
 KL349	Specific pannier holder for MONOKEY ® side cases <i>it can be mounted only with the specific rear rack KZ348</i>	
YAMAHA FZ1 1000 Fazer (06 > 14)		
 KZ359	Specific rear rack for MONOLOCK ® top case <i>we recommend mounting smaller cases MONOLOCK® in conjunction with KMSM or KM6M plates / It requires fitment of cases up to 37 ltr / maximum load allowed 6 kg / You have to puncture the housing under the tail in arranged sections</i>	
 KLX359	Specific pannier holder for K33 MONOKEY ® SIDE cases <i>it can be mounted without the specific rear rack KZ359 using the PLX359KIT / you must move the indicators from their original position</i>	
PLX359KIT	Specific kit to install the KLX and the KLXR without the rack for the top case	
KLXR359	Specific rapid release side case holder for K33 MONOKEY ® SIDE cases <i>it can be mounted without the specific rear rack KZ359 using the PLX359KIT / you must move the indicators from their original position</i>	
TKB02	 Specific "Tanky" base for Yamaha FZ1 Fazer (06 > 10) compatible with the tank bag TKB740	
 BF05K	Specific flange for fitting the tank bags with Tanklock system	
 KD437S	Specific screen, smoked 52 x 44 cm (H x W) <i>14 cm higher than the original</i>	
YAMAHA YZF R1 1000 (09 > 12)		
 BF05K	Specific flange for fitting the tank bags with Tanklock system	
 KD2106S	Specific screen, smoked 38 x 32 cm (H x W) <i>to be mounted instead of the original screen</i>	

MOTORCYCLE ACCESSORIES

CODE	DESCRIPTION	PRICE
YAMAHA BT 1100 Bulldog (02 > 09)		
 KZ350	Specific rear rack for MONOKEY ® or MONOLOCK ® top case to be combined with the MONOKEY ® KM5 or KM7 plates, or with the MONOLOCK ® KMSM or KM6M plates	
YAMAHA XV 1100 Virago (89 > 99)		
 23A	Universal screen, 38,8 x 41 cm (H x W) to be combined with the specific AS99A2 fitting kit	
A35N	Universal screen, 54,9 x 46,8 cm (H x W) to be combined with the specific AS99A2 fitting kit	
YAMAHA XVS 1100 Drag Star (99 > 02)		
 A35N	Universal screen, 54,9 x 46,8 cm (H x W) to be combined with the specific AS100A2 fitting kit	
23A	Universal screen, 38,8 x 41 cm (H x W) to be combined with the specific AS100A2 fitting kit	
AS100A2	Specific fitting kit for 23A and A35N	
YAMAHA XVS 1100 Drag Star Classic (00 > 02)		
 A39	Universal screen, transparent 51,7 x 57,3 cm (H x W) to be combined with the specific AS102A2 fitting kit/ High version	
AS102A2	Specific fitting kit for A39	
YAMAHA FJ 1100		
 K2970	Specific rear rack for MONOKEY ® or MONOLOCK ® top case To be combined with the plate MONOKEY ® K553N, or with the plate MONOLOCK ® MKN	
YAMAHA XT1200Z Superteneré (10 > 14)		
 KRA2101	Specific rear rack in aluminium for MONOKEY ® top case it can be fitted with the original side-case / to open the original side-cases you ought to remove the back top case from the plate / maximum load allowed 6kg / it does not allow the assembly of the stop light kit or the remote control device on the case	
KR371	Specific rear rack for MONOKEY ® top case MONOKEY ® plate included / is compatible with the original side case holder / to open the original side-cases you ought to remove the back top case from the plate	
 KL2119	Specific pannier holder for MONOKEY ® side cases	
KLR2119	Specific rapid release side case holder for MONOKEY ® cases	
KLR367	Specific rapid release side case holder for MONOKEY ® cases	
 BF05K	Specific flange for fitting the tank bags with Tanklock system	
 KD447ST	Specific screen, transparent 57 x 44 cm (H x W) 13 cm higher than the original	
KAF447	Specific Airstream sliding wind-screen transparent. Maximum height 61 cm (12 cm of extension), width 43 cm complete with specific fitting kit / to be mounted instead of the original screen	
 KN355	Specific engine guard we recommend fitting by a qualified mechanic / black colour	
RP2119	Oil carter protector in Aluminium	
YAMAHA XT1200ZE Superteneré (14) NEW		
 KRA2101	Specific rear rack in aluminium for MONOKEY ® top case it can be fitted with the original side-case / to open the original side-cases you ought to remove the back top case from the plate / maximum load allowed 6kg / it does not allow the assembly of the stop light kit or the remote control device on the case	
 KL2119	Specific pannier holder for MONOKEY ® side cases	
KLR2119	Specific rapid release side case holder for MONOKEY ® cases	
 BF05K	Specific flange for fitting the tank bags with Tanklock system	
 KD2119ST	Specific screen, transparent 56,5 x 50 cm (h x w) to be mounted instead of the original screen / 11 cm higher than original	
 RP2119	Oil carter protector in Aluminium	
KN355	Specific engine guard we recommend fitting by a qualified mechanic / black colour	



👉 = Item available until it runs out of stock

CODE	DESCRIPTION	PRICE
VARIOUS ACCESSORIES ES2119K	Specific support in aluminum and stainless steel to widen the surface support area of the original side stand	
YAMAHA	XJR 1200 (95 > 98)	
 K3410	Specific rear rack for MONOKEY ® or MONOLOCK ® top case <i>To be combined with the plate MONOKEY® K553N, or with the plate MONOLOCK® MKN</i>	
YAMAHA	FJR 1300 (01 > 05)	
 KR346	Specific rear rack for MONOKEY ® top case <i>is compatible with the original side case holder / MONOKEY® plate included / maximum load allowed 6 Kg</i>	
KR346M	Specific rear rack for MONOKEY ® top case <i>is compatible with the original side case holder / MONOKEY® plate included / maximum load allowed 6 Kg</i>	
 KD134ST	Specific screen, transparent 47 x 51 cm (H x W) <i>5 cm higher than the original</i>	
YAMAHA	FJR 1300 (06 > 12)	
 KRA2109	Specific rear rack in aluminium for MONOKEY ® top case <i>maximum load allowed 6kg / it does not allow the assembly of the stop light kit or the remote control device on the case</i>	
K228	Specific rear rack for MONOKEY ® top case <i>maximum load allowed 6 Kg / MONOKEY® plate included</i>	
K228M	Specific rear rack for MONOLOCK ® top case <i>maximum load allowed 6 Kg / MONOLOCK® plate included</i>	
KR357	Specific rear rack for MONOKEY ® top case	
 BF05K	Specific flange for fitting the tank bags with Tanklock system	
 KD436ST	Specific screen, transparent 52 x 49,5 cm (H x W) <i>5 cm higher than the original</i>	
YAMAHA	FJR 1300 (13 > 14)	
 KRA2109	Specific rear rack in aluminium for MONOKEY ® top case <i>maximum load allowed 6kg / it does not allow the assembly of the stop light kit or the remote control device on the case</i>	
K228	Specific rear rack for MONOKEY ® top case <i>maximum load allowed 6 Kg / MONOKEY® plate included</i>	
K228M	Specific rear rack for MONOLOCK ® top case <i>maximum load allowed 6 Kg / MONOLOCK® plate included</i>	
KR357	Specific rear rack for MONOKEY ® top case	
 KD2109ST	Specific screen, transparent 55,3 x 53 cm (H x W)	
 KN21090X	Specific engine guard, stainless steel <i>we recommend fitting by a qualified mechanic / stainless steel</i>	
YAMAHA	XJR 1300 (98 > 02)	
 K3410	Specific rear rack for MONOKEY ® or MONOLOCK ® top case <i>To be combined with the plate MONOKEY® K553N, or with the plate MONOLOCK® MKN</i>	
YAMAHA	XJR 1300 (04 > 06)	
 K3550	Specific rear rack for MONOKEY ® or MONOLOCK ® top case <i>To be combined with the plate MONOKEY® K553N, or with the plate MONOLOCK® MKN</i>	
YAMAHA	XJR 1300 (07 > 14)	
 K3610	Specific rear rack for MONOKEY ® or MONOLOCK ® top case <i>To be combined with the plate MONOKEY® K553N, or with the plate MONOLOCK® MKN</i>	
 BF05K	Specific flange for fitting the tank bags with Tanklock system	
VARIOUS ACCESSORIES 055KIT	Specific kit to mounting the KS900A Smart Bar	
YAMAHA	XVS 1300 Midnight Star (07 > 14)	
 AS103A2	Specific fitting kit for A46, A47	

MOTORCYCLE ACCESSORIES

PLATES

Various solutions are available to combine a top case with motorcycle models having a standard carrier or adaptation available to accept a top case. Plates are a simple solution to enhance the functionality of the motorcycle.

K628 Universal nylon plate, included in the MONOLOCK® top-case



K636 Universal MONOKEY® plate with fitting kit to fit a case on a scooter already with a rack



K553N Joint Z890K and nylon plate with fitting kit, to be mounted with Monorack K.... Suitable for MONOKEY® top-case



MKN Joint (Z890K) and plate in alluminum with fitting kit, to be mounted with Monorack K..... Suitable for MONOLOCK® top-case



MKL Joint set (Z896K) and plate in alluminum, to be mounted with Monorack K...L. Suitable for Monolock® top-cases

KM5 Nylon top plate with fitting kit included, to be mounted with Monorack KZ and KR. Suitable for Monokey® top-cases



KM5M Nylon top plate with fitting kit included, to be mounted with Monorack KZ and KR. Suitable for Monolock® top-cases



KM6M Monolock® Plate in nylon with place for the "u" type padlock to be used with Monorack KZ



KM7 MONOKEY® Nylon plate to be mounted with Monorack KZ



Monorack® K.. - KZ... - K...L

Highly tested and compatible with the whole range of KAPPA MONOKEY® and MONOLOCK® cases, the MONORACK fitting system for top cases is composed of a light alloy or plastic plate mounted by the exclusive aa every situation. Practicality and ease of use are guaranteed by the quick and essential assembling/disassembling system and by the availability of specific fitting Kits for the latest motorcycle models.

K1200 UNIVERSAL MONORACK

K1200 Universal rear rack for MONOKEY® or MONOLOCK® top case without plate and joint set
TO BE COMBINED WITH THE MONOKEY® K553N PLATE, OR WITH THE MONOLOCK® MKN PLATE



Wingrack® | K140 - K141

WINGRACK is best in reliability and design thanks to its robust correlation weight-endurance-dimensions which is the result of the use of light alloys and aeronautics concepts. It can be combined with the specific fitting kits produced for each motorcycle model.

K140

K140 WINGRACK, sideframes, 2 chassis with indicators for 3 cases without fitting kit, black only (K... required)



K141 WINGRACK, sideframes, 2 chassis without indicators, for 3 bags, without fitting kit, black only (K8... required)



MOTORCYCLE ACCESSORIES

SPAREPARTS

KGR52 GARDA

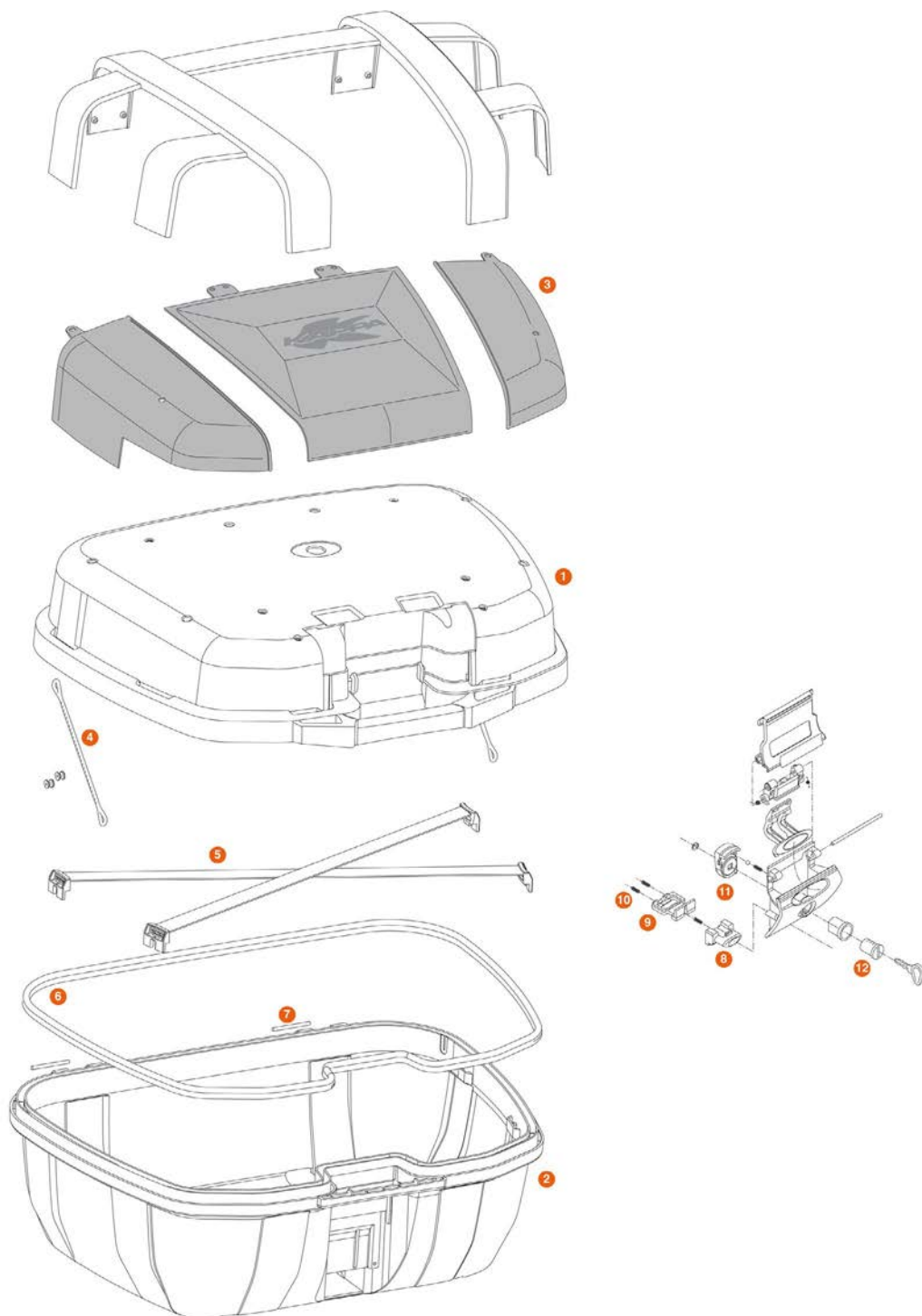

1	ZKGR52CNM	Mounted top-shell KGR52
2	ZKGR52FNM	Mounted bottom-shell KGR52
3	Z4720A900R	Painted cover
4	Z115R	Stop bag opening yarn, 2 pcs.
5	Z2170NR	Elastic belt
6	Z3220R	Rubber seal
7	Z590R	Pin. Medium, 2 pcs.

8	Z645CR	Push button
9	Z106	Bolt
10	Z109	Long bolt springs
11	Z640R	Plate below lock, 1 pcs.
12	K500N	Lock key black, 1 kit
	Z641NK46M	Complete hinge

KGR33 GARDA/KGR46 GARDA

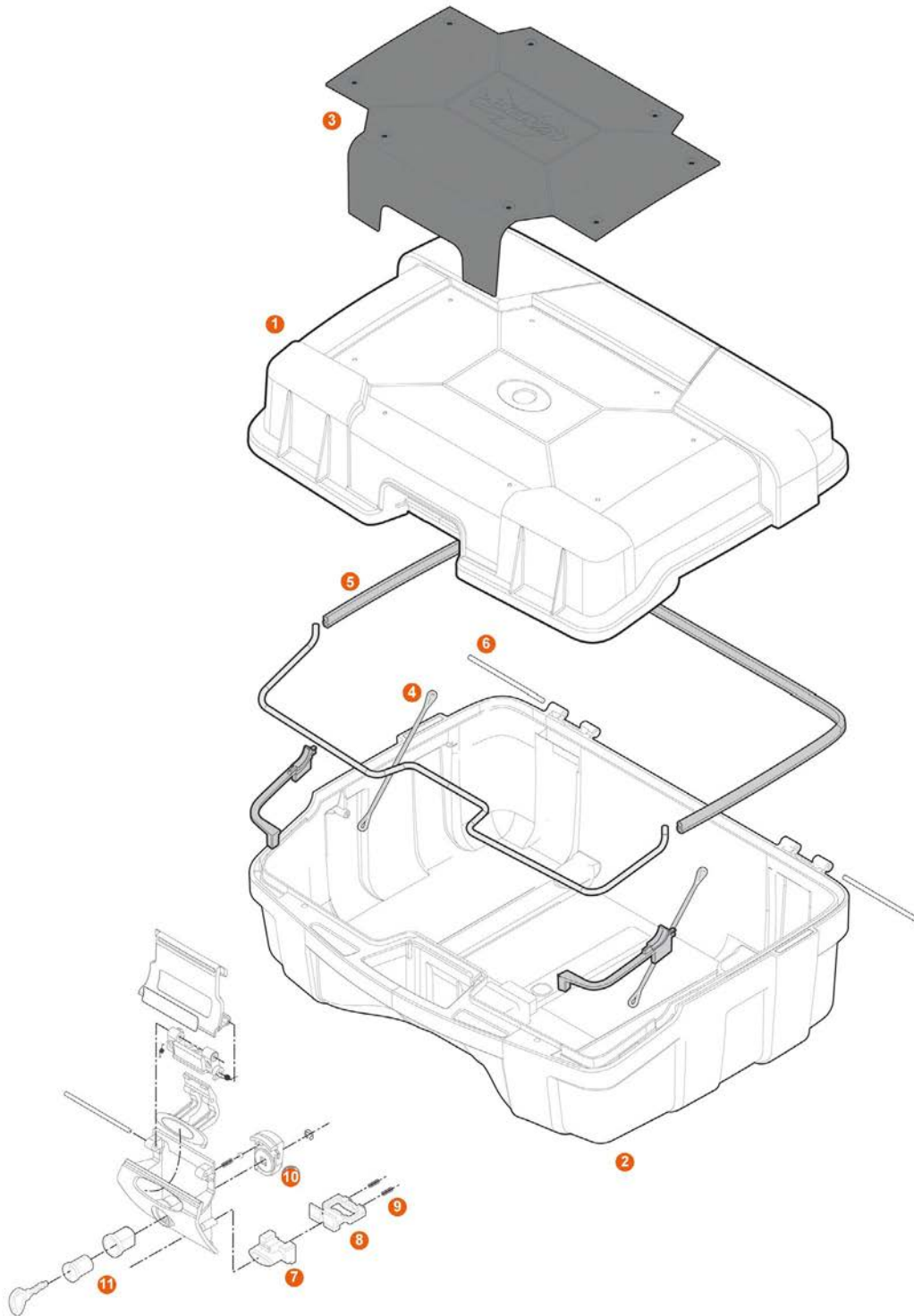

1	ZKGRCNM	Mounted top-shell
2	ZKGR46FNM	Mounted bottom-shell
2	ZKGR33FNM	Mounted bottom-shell
3	Z2291A900R	Painted cover
4	Z115R	Stop bag opening yarn, 2 pcs.
5	Z2072R	Rubber seal
6	Z590R	Pin. Medium, 2 pcs.
7	Z645CR	Push button

8	Z106	Bolt
9	Z109	Long bolt springs
10	Z640R	Plate below lock, 1 pcs.
11	K500N	Lock key black, 1 kit
	Z641NK46M	Complete hinge
	Z641NK33M	Complete hinge
	Z2106NR	Inner elastic belt, 1 pcs.
	GR2701KITR	Pair of hinges additional side

MOTORCYCLE ACCESSORIES

K53



1	Z53CNM	Top-shell, black (mounted)
2	Z53FNM	Bottom-shell, black (mounted)
3	Z1632R	Oval KAPPA Logo, in aluminium, 1 pcs.
4	Z633KR	Elastic belt
5	Z115R	Stop bag opening yarn, 2 pcs.
6	Z218GR	Grey rear band (left sx / right dx)
7	Z950TR	Reflector set
8	Z159R	Bag lock lining, 1 pcs.
9	Z661	Lock key, 1 kit
10	Z683NR	Complete hinge
11	Z289KR	Name-Address holder

12	Z686NR	Small black decoration set
13	Z223TR	Set Bottom Reflector
14	Z106	Bolt
15	Z109	Long bolt springs
16	Z339	Red pulley
17	Z160	Inner document holder
18	Z590R	Pin. Medium, 2 pcs.
	Z206R	Button + Button Spring
20	Z286	Glass for small name plate
21	Z1918R	Logo "K53"

K52

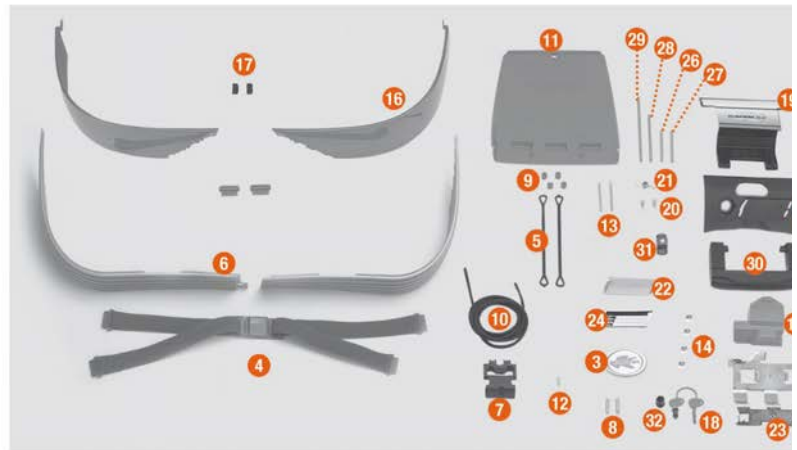

2	Z50FNMK	Bottom-shell, black (mounted)
3	Z1632R	Oval KAPPA Logo, in aluminium, 1 pcs.
4	K566	Elastic belt
5	Z115R	Stop bag opening yarn, 2 pcs.
7	Z106	Bolt
8	Z109	Long bolt springs
9	Z112R	Red pulley, 4 pcs.
10	Z159R	Bag lock lining, 1 pcs.
11	Z160	Inner document holder
12	Z1237 ↘	Push button spring with washer
13	Z590R	Pin. Medium, 2 pcs.
15	Z282 ↘	Push button
16	Z292RDX	Red Top case reflectors (right)
16	Z292RSX	Red Top case reflectors (left)

17	Z298	Handle felt
18	K500	Lock key, 1 kit
19	Z263KIT ↘	Silver sticker set
21	Z284	Lock spring
22	Z286	Glass for small name plate
23	Z287	Lock plate
24	Z289KR	Name-Address holder
25	Z290N	Hinge black
26	Z294	Pin 55,5 mm
28	Z296	Pin 101 mm
29	Z297	Pin 140 mm
31	Z307	Plate Below Lock
32	Z210	Chrome bushing for lock set

K49



1	K49CNM	Top-shell, black (mounted)
2	K49FNM	Bottom-shell, black (mounted)
3	Z106	Bolt
4	Z109	Long bolt springs
5	Z112R	Red pulley, 4 pcs.
6	Z160	Inner document holder
7	K566	Elastic belt
8	Z115R	Stop bag opening yarn, 2 pcs.
9	Z645R	Push button red, 1 pcs.
10	Z731	Top case reflector (right and left)
11	Z744R	Top case reflector, 1 kit
12	Z734NSET	Rear band set
13	Z741	Hook for fixing the document holder
14	Z1632R	Oval KAPPA Logo, in aluminium, 1 pcs.
15	Z769	Rubber seal

16	Z409R	Name holder, 1 pcs.
17	Z630	Steel spheres D. 6
18	Z632R	Steel torsion spring
19	Z637R	Pin. D. 04x75 mm, (1 piece)
20	Z640R	Plate below lock, 1 pcs.
21	Z641NR	Hinge black
22	Z643R	Lock set element red, 1 pcs.
23	Z644R	Opening push button, 1 pcs.
24	Z647R	Torsion spring, 1 pcs.
25	Z648	Cylinder spring
26	Z721R	Pin. D. 04x85 mm
27	K500	Lock key, 1 kit
28	Z210	Chrome bushing for lock set
SN	Z641NMK	Hinge complete

K49NT

K49CNTM	Mounted top-shell
K49FNTM	Mounted bottom-shell
Z641NNM	Complete hinge
Z644NR	Opening push button

Z645NR	Push button
K731TR	Pair of reflectors with silver background
Z744TR	Central reflector

MOTORCYCLE ACCESSORIES

K48



1	K48CNM	Top-shell, black (mounted)
2	K48FNM	Bottom-shell, black (mounted)
3	Z236	Hinge spring
4	Z159R	Bag lock lining, 1 pcs.
5	Z195	Pin D. 04x80 mm
6	Z210	Chrome bushing for lock set
7	Z312	Hinge plate
8	Z314N	Hinge black
8	Z314NM2K	Hinge, complete black
9	K546	Name-Address holder
10	Z1632R	Oval KAPPA Logo, in aluminium, 1 pcs.
11	K558	Plate for reflector
12	Z217	Push button

13	Z106	Bolt
14	Z109	Long bolt springs
15	Z1237 ↘	Push button spring with washer
16	Z277	Plate below lock
17	Z115R	Stop bag opening yarn, 2 pcs.
18	K566	Elastic belt
19	K615	Reflector
20	Z337	Top-case reflector
21	Z112R	Red pulley, 4 pcs.
22	615KA	White sticker for K615
23	Z590R	Pin. Medium, 2 pcs.
24	K500	Lock key, 1 kit

K961



1	K96CN	Top-shell, black
2	K96FN	Bottom-shell, black
3	Z183N	Hinge black
3	Z183NM	Hinge, complete
4	Z117	Hinge plate
5	Z159R	Bag lock lining, 1 pcs.
6	Z195	Pin D. 04x80 mm
7	K513	Logo KAPPA
8	K517	Belt
9	Z664 ↘	Stop bag opening yarn with plastic sleeve
10	Z210	Chrome bushing for lock set

11	K531	Reflector
12	K546	Name-Address holder
13	K554	Plate Below Lock
14	Z217	Push button
15	Z106	Bolt
16	Z109	Long bolt springs
17	Z1237 ↘	Push button spring with washer
18	Z112R	Red pulley, 4 pcs.
19	Z155	Pass belt
20	Z590R	Pin. Medium, 2 pcs.
21	K500	Lock key, 1 kit



↘ = Item available until it runs out of stock

K40



1	K40CNMDX	Top-shell, black (mounted-right)
1	K40CNMDX	Top-shell, black (mounted-left)
2	K48FNM	Bottom-shell, black (mounted)
3	Z236	Hinge spring
4	Z159R	Bag lock lining, 1 pcs.
5	Z195	Pin D. 04x80 mm
6	Z210	Chrome bushing for lock set
7	Z312	Hinge plate
8	Z314N	Hinge black
8	Z314NM2K	Hinge, complete black
9	K546	Name-Address holder
10	Z1632R	Oval KAPPA Logo, in aluminium, 1 pcs.
11	Z217	Push button
12	Z106	Bolt
13	Z109	Long bolt springs

14	Z1237	Push button spring with washer
15	Z277	Plate below lock
16	Z115R	Stop bag opening yarn, 2 pcs.
17	K566	Elastic belt
18	K622N902	Inserts Peints
19	K623D	Direction indicator (right)
19	K623S	Direction indicator (left)
20	K624D	Direction indicator (right)
20	K624S	Direction indicator (left)
21	K625	Plate for reflector with logo in relief
22	Z112R	Red pulley, 4 pcs.
23	Z590R	Pin. Medium, 2 pcs.
24	K500	Lock key, 1 kit
25	623KA	White sticker for K623

K21



1	Z21CNMDXK	Top-shell black Please specify (right dx)
1	Z21CNMSXK	Top-shell black Please specify (left sx)
3	Z109	Long bolt springs
4	Z159R	Bag lock lining, 1 pcs.
6	Z325	Pannier opening sticker
7	Z387	Bolt
8	Z388	Push button

9	Z389	Complete key lock plate
10	Z390	Pin D. 02x60 mm E21
11	Z605	Handle
12	Z606	Handle mounting set black
13	Z831	Spring push button
14	K500	Lock key, 1 kit
15	Z210	Chrome bushing for lock set

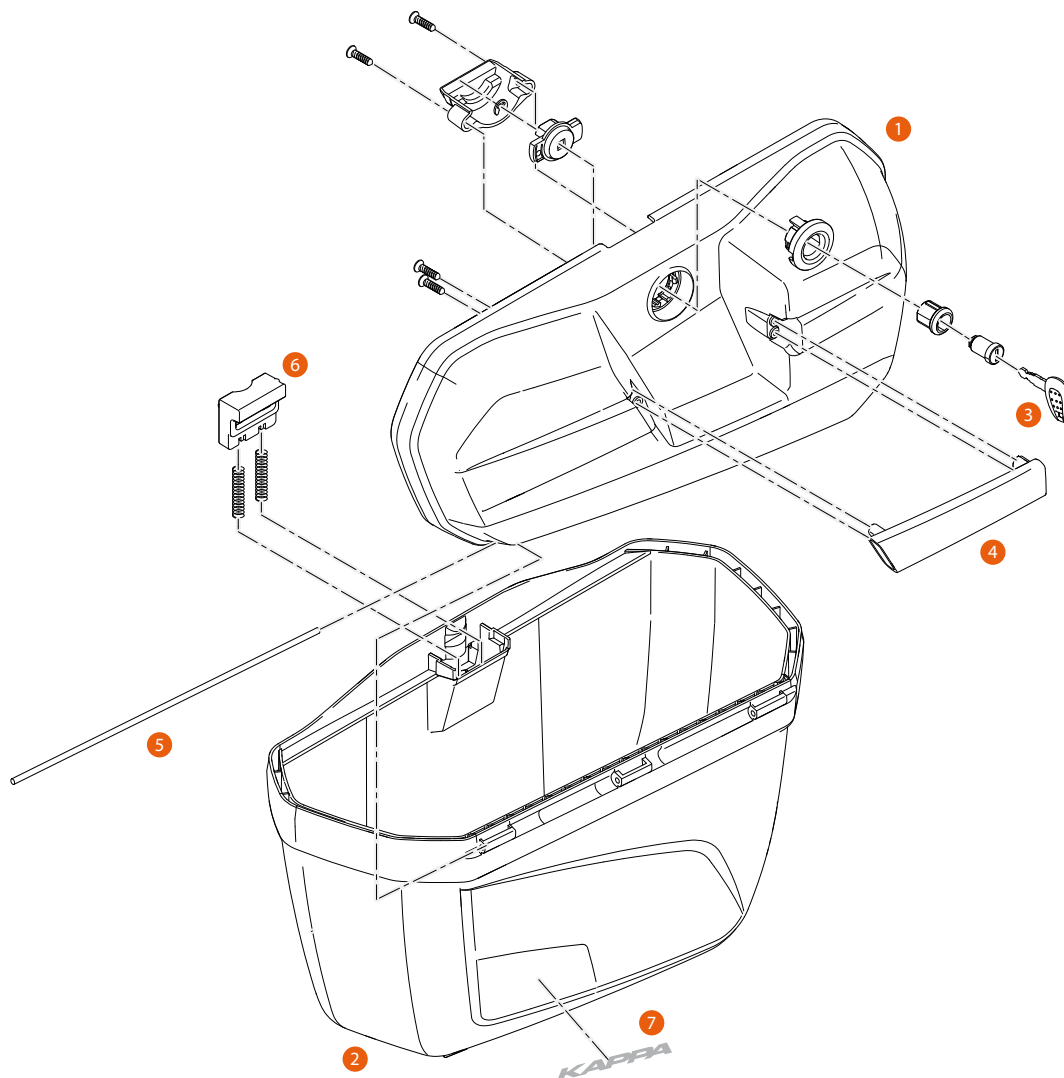

- 1 Z22CNDXM** K22 assembled top-shell (right)
- Z22CNSXM** K22 assembled top-shell (left)
- 2 KZ22FNDXM** Mounted bottom-shell (right)
- KZ22FNSXM** Mounted bottom-shell (left)
- 3 Z4023R** Key locks with corresponding bush for K22

- 4 Z4020R** Pair of handles for K22
- 5 ZS310R** Pin. Medium, for K22
- 6 Z4025R** Bolt with springs for K22
- 7 KZ22R** Logo sticker for K22, 2 pcs.



↘ = Item available until it runs out of stock

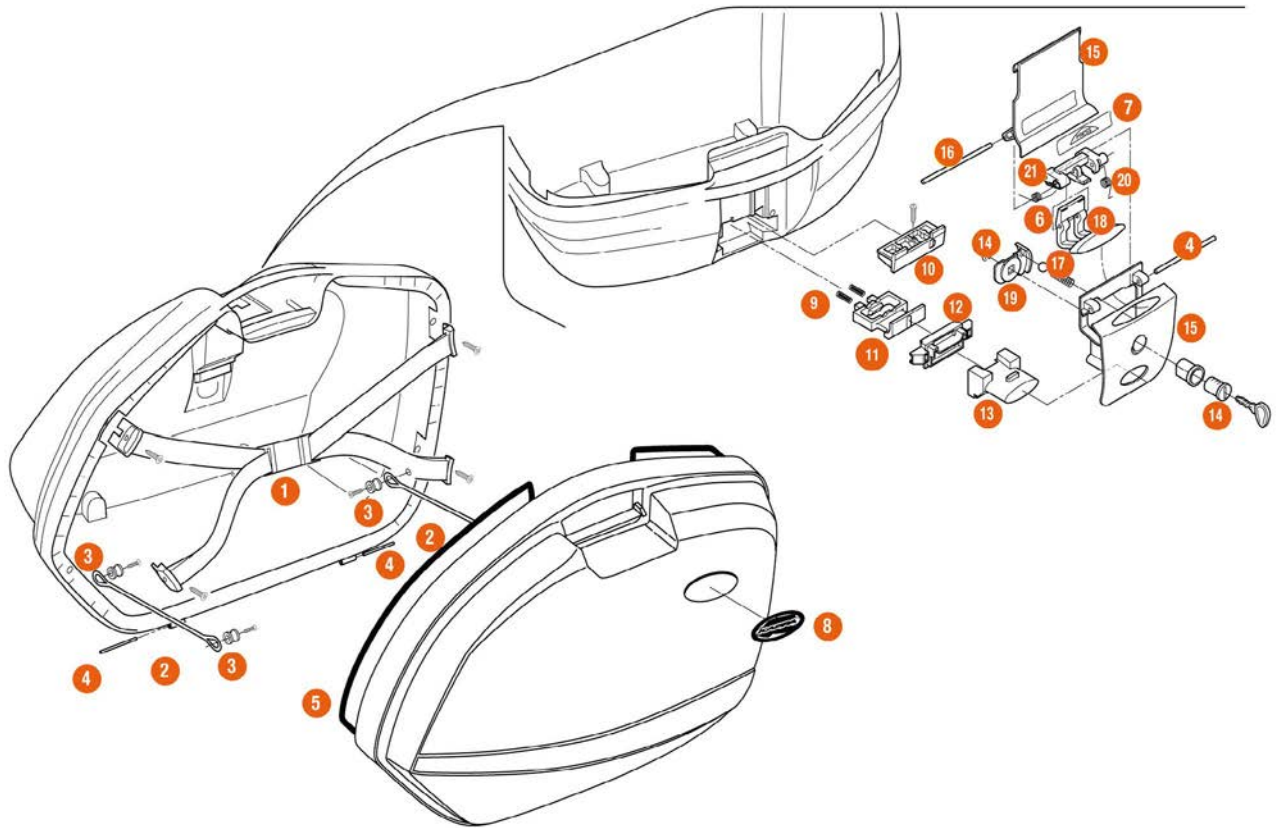

1	Z1547R	Inner elastic belt, 1 pcs.
2	Z115R	Stop bag opening yarn, 2 pcs.
3	Z112R	Red pulley, 4 pcs.
4	Z637R	Pin. D. 04x75 mm, (1 piece)
5	Z769	Rubber seal
6	Z632R	Steel torsion spring
7	Z409R	Name holder, 1 pcs.
8	Z1632R	Oval KAPPA Logo, in aluminium, 1 pcs.
9	Z109	Long bolt springs
10	Z1404R	Push button guide 1pcs.
11	Z106	Bolt
12	Z1405R	Right and left visor mechanism
13	Z645R	Push button red, 1 pcs.
14	K500	Lock key, 1 kit

15	Z641NR	Hinge black
16	Z721R	Pin. D. 04x85 mm
17	Z1384R	Cylinder spring and steel spheres, 1 kit
18	Z644R	Opening push button, 1 pcs.
19	Z640R	Plate below lock, 1 pcs.
20	Z647R	Torsion spring, 1 pcs.
21	Z643R	Lock set element red, 1 pcs.
	ZK33FNDX	Right bottom-shell (mounted)
	ZK33FNSX	Left bottom-shell (mounted)
	ZK33CNDX	Right top-shell (mounted)
	ZK33CNSX	Left top-shell (mounted)
	Z641NMK	Hinge complete
	K33NDX	Right side

MOTORCYCLE ACCESSORIES

K47 MANTA

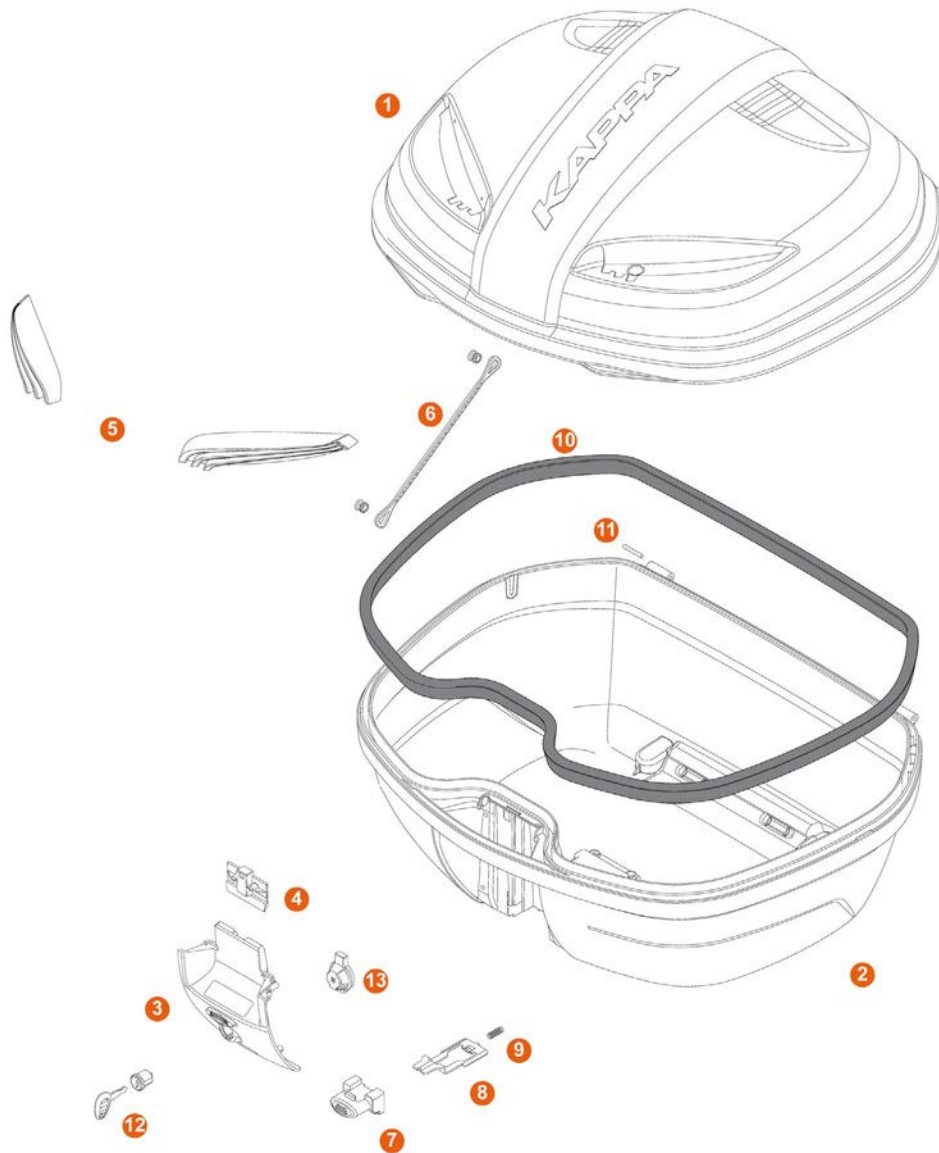

K47N / K47NN TECH

1	ZK47CNM	Mounted top-shell
1	ZK47CNUM	Mounted top-shell K47NN
2	ZK47FNM	Mounted bottom-shell
3	ZK3007NM	Hinge, complete N/NN version
4	Z3012R	Lock key system for top-shell
5	Z470R	Top-case reflector, red
6	Z599	Stop bag opening yarn 188mm

7	Z1983R	Push button, red
8	Z761NR	Bolt, 1 pcs.
9	Z191R	Push button spring, 1 pcs.
10	Z790R	Rubber seal
11	Z590R	Pin. Medium, 2 pcs.
12	Z156	Key lock complete of bushing and black cap
13	Z3006R	Below lock, red

K47NT / K47B

1	ZK47CNTM	Mounted top-shell
1	ZK47CBM	Mounted top-shell
2	ZK47FNTM	Mounted bottom-shell
3	ZK3007NTM	Hinge, complete NT version
4	Z3012R	Lock key system for top-shell
5	Z470FR	Smoked op-case reflector
6	Z599	Stop bag opening yarn 188mm

7	Z645CR	Push button
8	Z761NR	Bolt, 1 pcs.
9	Z191R	Push button spring, 1 pcs.
10	Z790R	Rubber seal
11	Z590R	Pin. Medium, 2 pcs.
12	K500N	Lock key black, 1 kit

K46N



1	K46CNM	Top-shell, black (mounted)
2	Z450FNMK	Bottom-shell, black (mounted)
3	Z1632R	Oval KAPPA Logo, in aluminium, 1 pcs.
4	Z115R	Stop bag opening yarn, 2 pcs.
5	Z112R	Red pulley, 4 pcs.
6	Z113	Nylon plate for Monolock cases
7	Z114K ↘	Cover plate for Z113
8	Z159R	Bag lock lining, 1 pcs.
9	Z590R	Pin. Medium, 2 pcs.
10	Z191R	Push button spring, 1 pcs.
11	Z629DX	Reflector (right)
11	Z629SX	Reflector (left)
12	Z642	Central reflector for K46
13	Z846	Circuit covering cap, 1 pcs.
14	Z873	Antitheft hole black cover
15	Z665	Logo for reflector (Z642)
16	Z409R	Name holder, 1 pcs.

17	Z410D	Universal fitting kit for plate
18	Z632R	Steel torsion spring
19	Z637R	Pin. D. 04x75 mm, (1 piece)
20	Z210	Chrome bushing for lock set
21	Z640R	Plate below lock, 1 pcs.
22	Z641NR	Hinge black
	Z641NMK	Hinge complete
23	Z643R	Lock set element red, 1 pcs.
24	Z644R	Opening push button, 1 pcs.
25	Z645R	Push button red, 1 pcs.
26	Z647R	Torsion spring, 1 pcs.
27	Z648	Cylinder spring
28	Z721R	Pin. D. 04x85 mm
29	Z762NR	Bolt, 1 pcs.
30	K500	Lock key, 1 kit
31	Z126	Plate rubber Monorack/Wingrack
32	Z658	White sticker for Z629 dx/sx

K46NT

K46CNTM	Mounted top-shell
Z450FNTMK	Mounted bottom-shell
Z641NNM	Complete hinge
Z644NR	Opening push button

Z645NR	Push button
Z629TR	Pair of side reflectors
Z642FR	Central reflector
Z156N	Key lock complete of bushing and black cap

MOTORCYCLE ACCESSORIES

K37N/ K37 TECH / K37NN

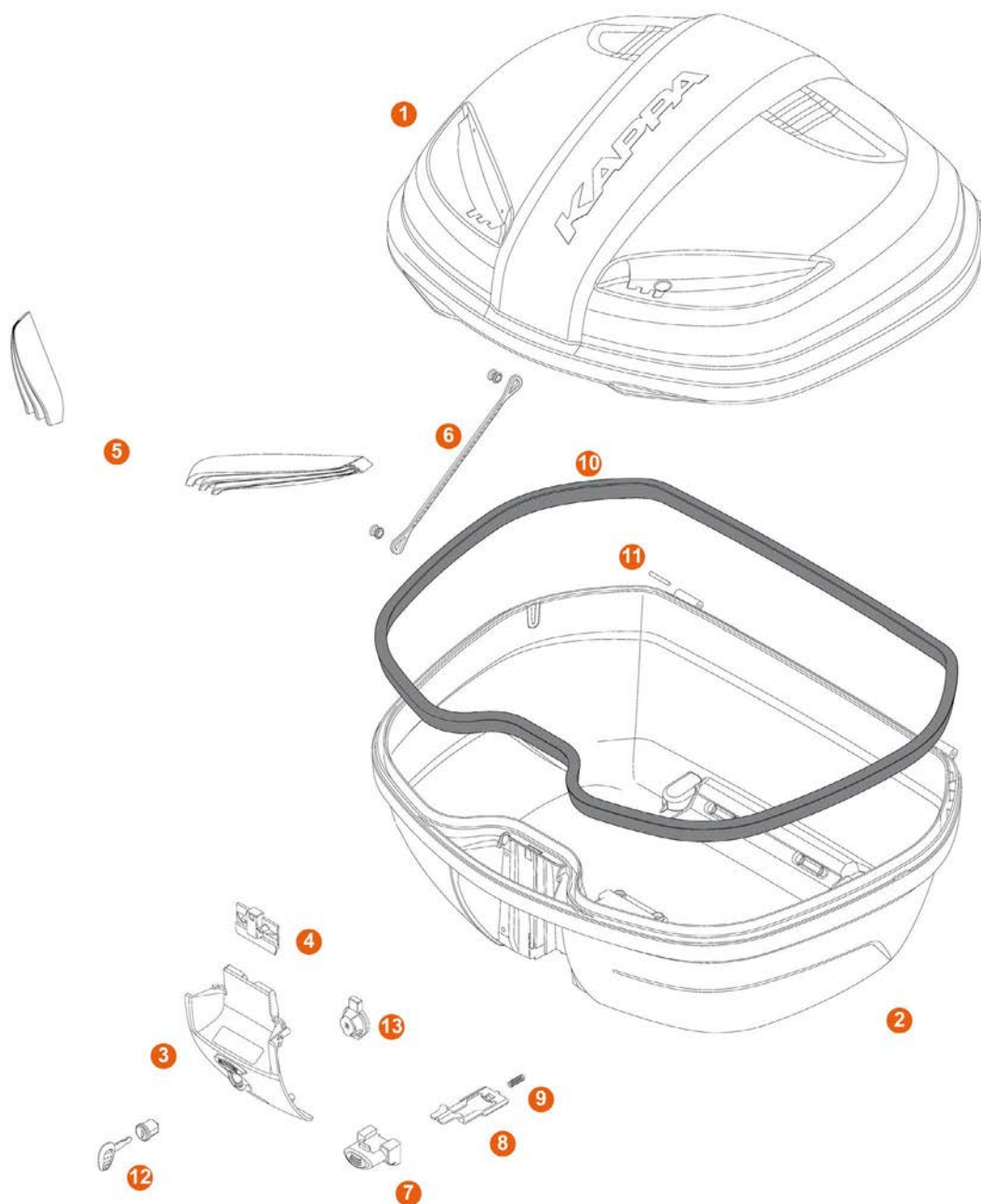

1	ZK37CNUM	Mounted top-shell K37NN
1	ZK37CNM	Mounted top-shell K37N
1	ZK37CNTM	Mounted bottom-shell K37NT
2	ZK37FNM	Mounted bottom-shell K37N / K37NN
2	ZK37FNTM	Mounted bottom-shell K37NT
3	ZK3007NM	Hinge, complete N/NN version
3	ZK3007NTM	Hinge, complete NT version
4	Z3012R	Lock key system for top-shell
5	Z470R	Top-case reflector, red
5	Z470FR	Smoked op-case reflector
6	Z599	Stop bag opening yarn 188mm

7	Z1983R	Push button, red for K37N / K37NN
7	Z645CR	Push button crhomed for K37NT
8	Z761NR	Bolt, 1 pcs.
9	Z191R	Push button spring, 1 pcs.
10	Z790R	Rubber seal
11	Z590R	Pin. Medium, 2 pcs.
12	Z156	Key lock complete of bushing and black cap for K37N/ K37NN
12	K500N	Lock key black for K37NT, 1 kit
13	Z3006R	Below lock, red for K37N/K37NN

K35/K35BMAL



1	K35CNM	Top-shell, black (mounted)
2	Z350FNMK	Bottom-shell, black (mounted)
3	Z726	Black lock lining
4	Z191R	Push button spring, 1 pcs.
5	Z210	Chrome bushing for lock set
6	Z1632PVCR	Oval KAPPA Logo, PVC
7	Z409R	Name holder, 1 pcs.
8	K571	Sticker set (dx sx)
9	K626DX	Reflector (right)
9	K626SX	Reflector (left)
10	Z112R	Red pulley, 4 pcs.
11	Z113	Nylon plate for Monolock cases
12	Z114K ↘	Cover plate for Z113
13	Z115R	Stop bag opening yarn, 2 pcs.
14	Z410D	Universal fitting kit for plate
15	Z632R	Steel torsion spring
16	Z635R	Pin. D. 04x48 mm, 2 pcs.

17	Z637R	Pin. D. 04x75 mm, (1 piece)
18	Z640R	Plate below lock, 1 pcs.
19	Z641NR	Hinge black
19	Z641NMK	Hinge complete
20	Z643R	Lock set element red, 1 pcs.
21	Z644R	Opening push button, 1 pcs.
22	Z645R	Push button red, 1 pcs.
23	Z647R	Torsion spring, 1 pcs.
24	Z648	Cylinder spring
25	Z721R	Pin. D. 04x85 mm
26	Z761NR	Bolt, 1 pcs.
27	Z873	Antitheft hole black cover
28	Z929S	Front KAPPA Logo (Silk screen printed)
29	626KA ↘	White sticker for K626
30	K500	Lock key, 1 kit
31	Z126	Plate rubber Monorack/Wingrack

K35NT

K35CNTM	Mounted top-shell
Z350FNTMK	Mounted bottom-shell
Z641NNM	Complete hinge
Z644NR	Opening push button

Z645NR	Push button
K626TR	Pair of transparent reflectors
Z929NR	Frontalino centrale per K35NT
Z156N	Key lock complete of bushing and black cap

MOTORCYCLE ACCESSORIES

K30



1	ZK30CNM	Top-shell, black (mounted)
2	ZK30FNM	Bottom-shell, black (mounted)
3	Z1724R	Reflector with white background
4	Z1632R	Oval KAPPA Logo, in aluminium, 1 pcs.
5	Z314NM2K	Hinge, complete black
6	Z191R	Push button spring, 1 pcs.

7	Z193	Hinge pin 62 mm
8	Z310	Bolt
9	Z315	Push button
11	Z410D	Universal fitting kit for plate
12	Z113	Nylon plate for Monolock cases
13	Z114K	Cover plate for Z113

K30B

ZK30CBM	Mounted top-shell white moulded
ZK30FBM	Mounted bottom-shell
Z314NNM	Complete hinge

Z315NR	Push button
Z1724FR	Smoked reflector

K30NT

ZK30CNTM	K30NTN assembled top-shell
ZK30FNTM	K30NTN assembled bottom-shell

Z1724FR	Smoked reflector
Z314NTM	Mounted lock set for K30NT



↘ = Item available until it runs out of stock

K28N



1	K28CNM	Top-shell, black (mounted)
2	K94FNM	Bottom-shell, black (mounted)
3	Z159R	Bag lock lining, 1 pcs.
4	Z191R	Push button spring, 1 pcs.
5	Z195	Pin D. 04x80 mm
6	Z193	Hinge pin 62 mm
7	Z210	Chrome bushing for lock set
8	Z315	Push button
9	Z312	Hinge plate
10	Z310	Bolt
11	Z243	Key lock plate
12	Z314N	Hinge black

12	Z314NM2K	Hinge, complete black
13	K546	Name-Address holder
14	Z1632R	Oval KAPPA Logo, in aluminium, 1 pcs.
15	Z845K	Top-case reflector
16	Z113	Nylon plate for Monolock cases
17	Z114K	Cover plate for Z113
18	Z410D	Universal fitting kit for plate
19	Z873	Antitheft hole black cover
20	Z843	White sticker for K617
21	K500	Lock key, 1 kit
22	Z236	Hinge spring
23	Z126	Plate rubber Monorack/Wingrack

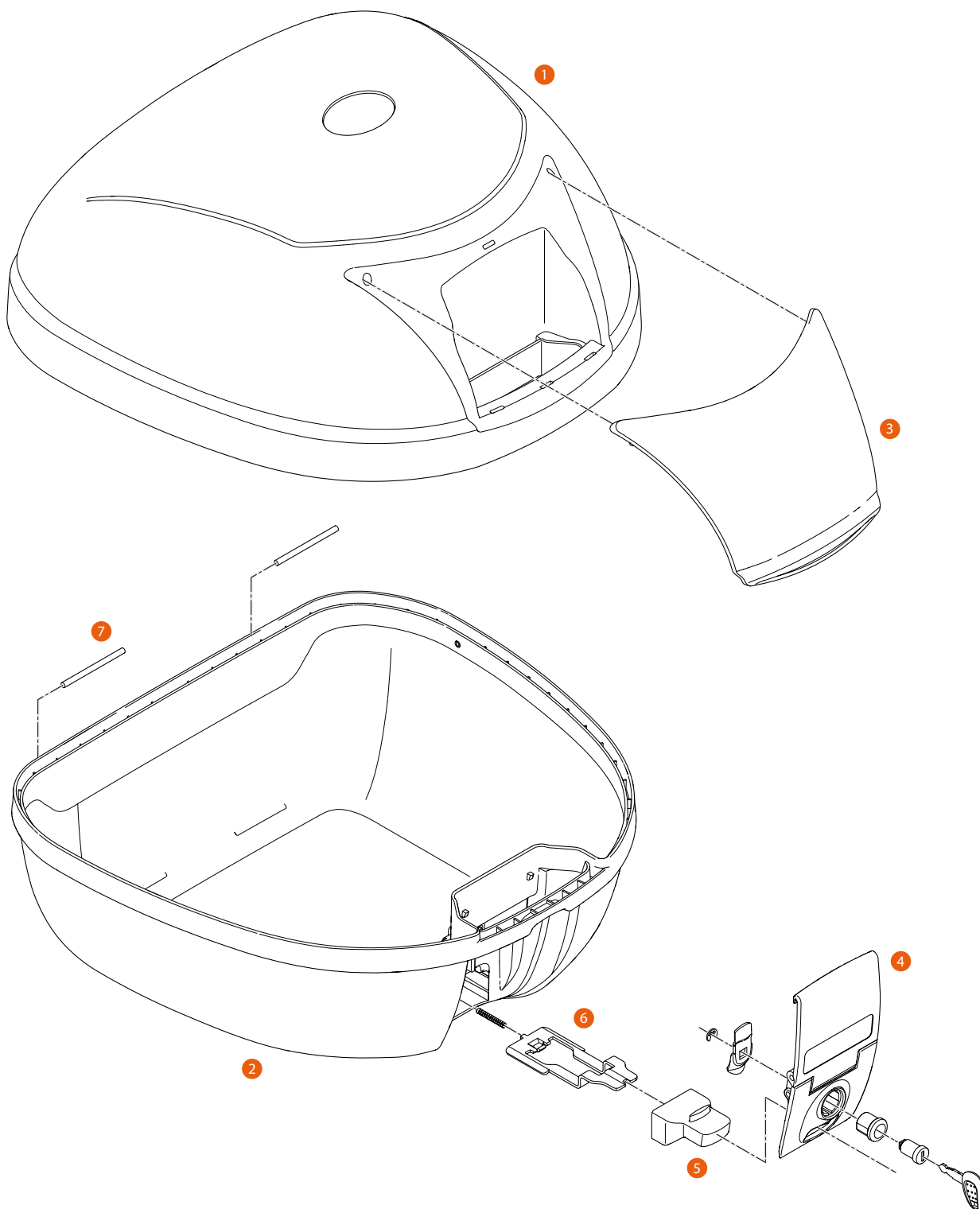

- | | | |
|---|-------------------|-------------------------------|
| 1 | ZK28BASCNM | Top-shell, black (mounted) |
| 2 | ZK28BASFNM | Bottom-shell, black (mounted) |
| 3 | Z3761R | Reflector for K28BAS |
| 4 | Z314NM2K | Mounted lock set for K28BAS |

- | | | |
|---|-------------|------------------------------|
| 5 | Z315 | Push button |
| 6 | Z310 | Bolt with springs for K28BAS |
| 7 | Z193 | Hinge pin |



↘ = Item available until it runs out of stock

K26



1	K26CNM	Top-shell, black (mounted)
3	Z1632PVC	Oval KAPPA Logo, PVC
4	Z112R	Red pulley, 4 pcs.
5	Z113	Nylon plate for Monolock cases
6	Z114K	Cover plate for Z113
7	Z115R	Stop bag opening yarn, 2 pcs.
8	Z191R	Push button spring, 1 pcs.
9	Z210	Chrome bushing for lock set
10	Z310	Bolt
11	Z409R	Name holder, 1 pcs.
12	Z410D	Universal fitting kit for plate
13	Z632R	Steel torsion spring
14	Z635R	Pin. D. 04x48 mm, 2 pcs.
15	Z637R	Pin. D. 04x75 mm, (1 piece)

16	Z640R	Plate below lock, 1 pcs.
17	Z641NR	Hinge black
	Z641NMK	Hinge complete
18	Z643R	Lock set element red, 1 pcs.
19	Z644R	Opening push button, 1 pcs.
20	Z645R	Push button red, 1 pcs.
21	Z647R	Torsion spring, 1 pcs.
22	Z648	Cylinder spring
23	Z721R	Pin. D. 04x85 mm
24	Z873	Antitheft hole black cover
26	K500	Lock key, 1 kit
27	Z929SK26	Front KAPPA Logo (Silk screen printed)
28	672KA	White sticker for Z672
29	Z126	Plate rubber Monorack/Wingrack

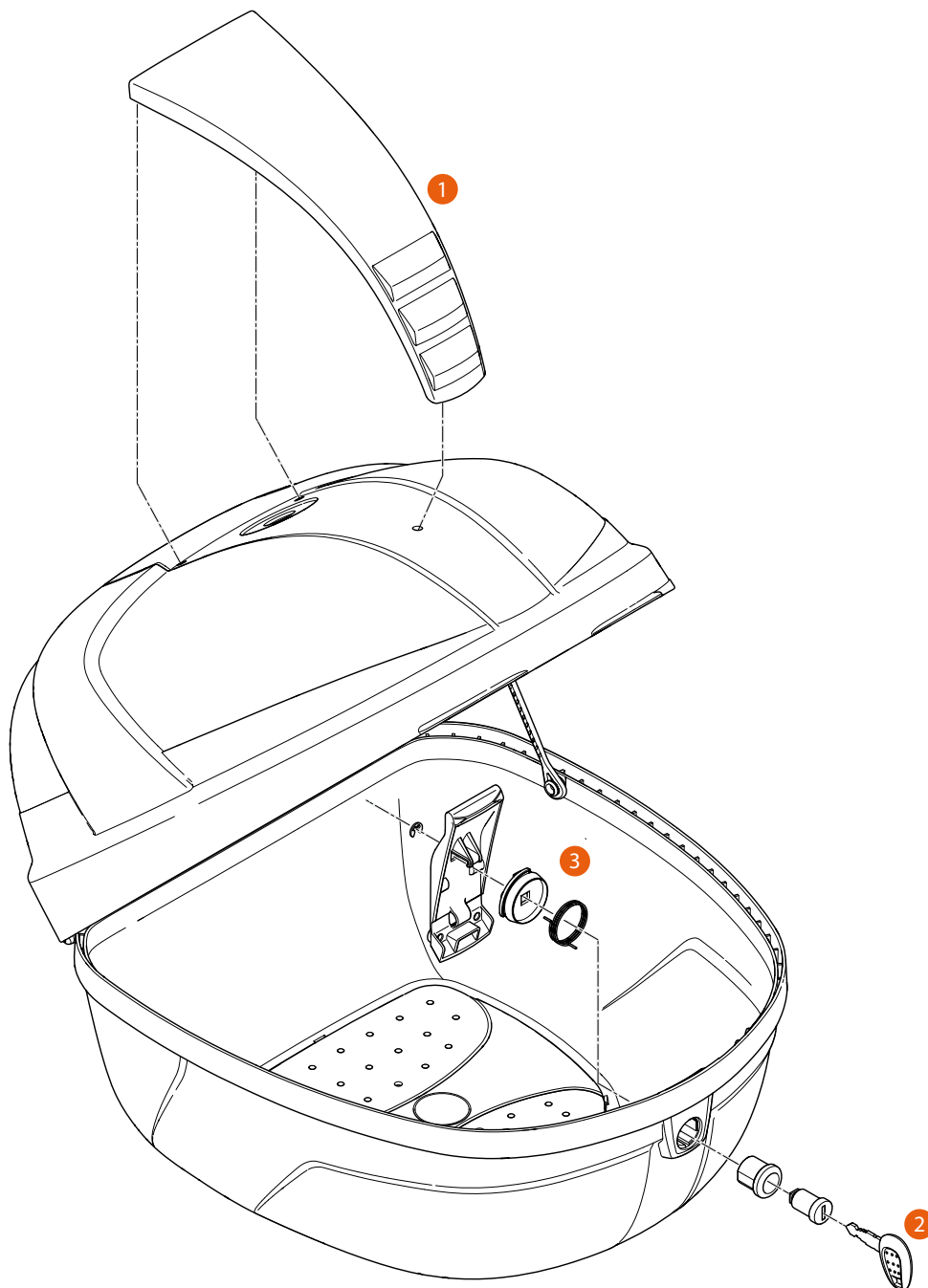

- 1 Z1730TR** Reflector for KCY25N
- 2 Z1734R** Below lock

- 3 Z140R** Key lock complete of bushing and black cap



↘ = Item available until it runs out of stock

KCY14N

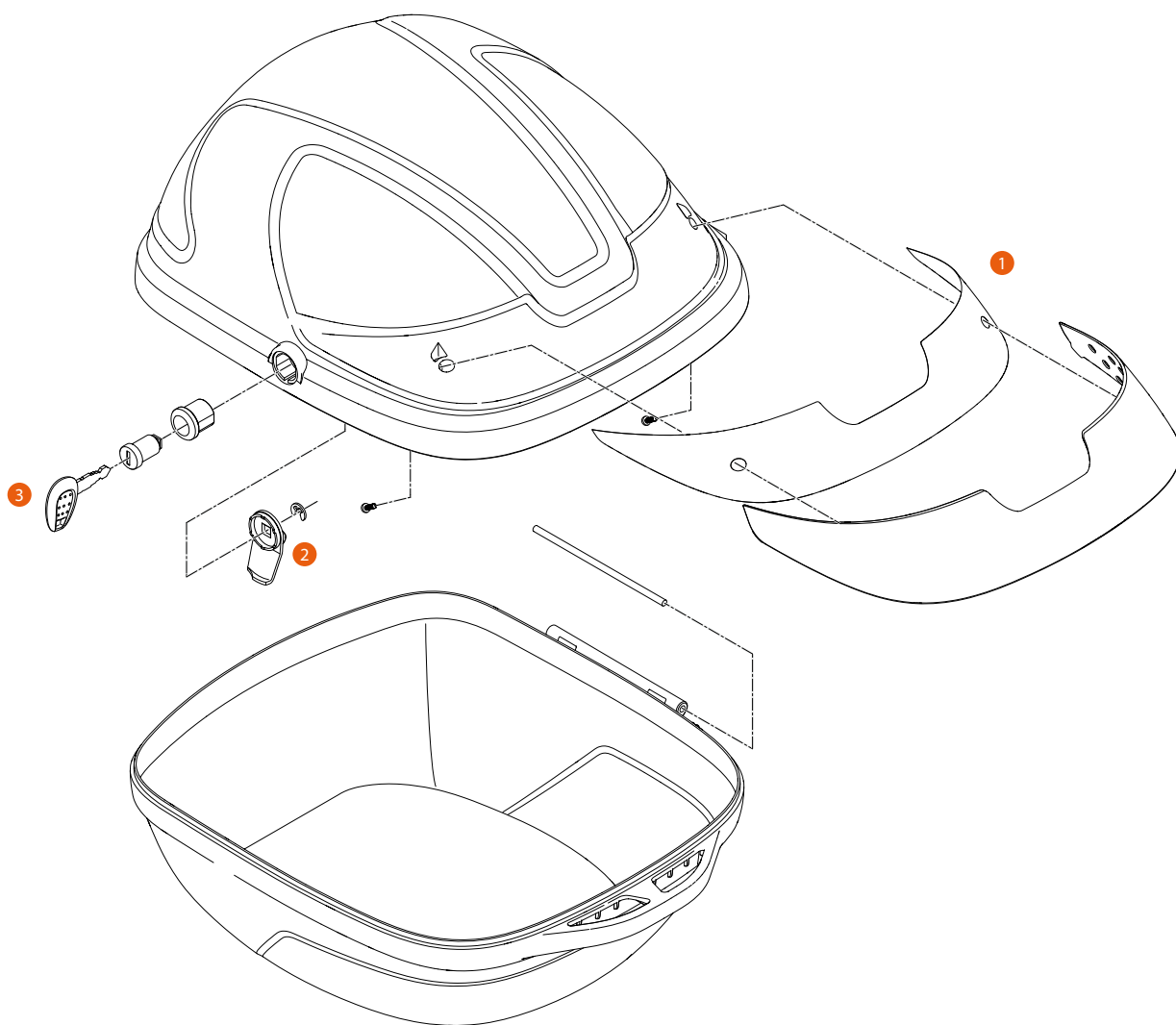

- 1 Z3101TR** Reflector for KCY14N
- 2 Z3102R** Below lock

- 3 Z140R** Key lock complete of bushing and black cap

MOTORCYCLE ACCESSORIES

MONORACK



- 1 Z890K** 1 joint set for Monorack 2/3/MKN
- 2 Z124** Bag case attachment clamps
- 3 Z125** Bag case attachment mushroom spacer (2pcs)

- 4 Z896K** 1 set joint Monorack 35 mm
- 5 Z128** Complete kit for plastic boss for Wingrack

WINGRACK



- 2 Z163DX** Wingrack 1 fin (right)
- 2 Z163SX** Wingrack 1 fin (left)
- 3 Z145DX** Wingrack direction indicator (1piece) (right)

- 3 Z145SX** Wingrack direction indicator (1piece) (left)
- 4 Z231** Direction indicator lens for Z145

PLATES



- 1 Z622MK** Nylon plate for MONOKEY® cases
- 2 Z667MK** Nylon plate for MONOLOCK® cases
- 3 Z340K** Aluminium plate for Monolock cases
- 4 Z255K** Nylon plate for Monokey cases

- 5 Z2710** Plate rubber Monorack/Wingrack
- 6 Z113** Nylon plate for Monolock cases
- 7 Z114K** Cover plate for Z113

KL/KLR



- 1 Z221** Rubber
- 2 Z670** Screw cap for hook for sidecase holder, 1 piece
- 3 Z124** Bag case attachment clamps

- 4 Z125** Bag case attachment mushroom spacer (2pcs)
- 5 Z2711R** Replacement key for the tubular side-case holders with rapid fitting. KLXR and KLR

STOP LIGHT KIT



- 1 Z1081** Spare top-shell contact for stop light
- 2 Z1089** Spare contact between top and bottom shell
- 3 Z880** Plate contact with wire for stoplight kit
- 4 Z995M** Spare part between bottom-shell and plate
- Z2111R** The plate contact has a cable with 3 terminals (spare part for the devices with remote-controlled opening)
- Z2109R** The contact with the bottom-shell of the case has 3 terminals (spare part for the devices with remote-controlled opening)

MOTORCYCLE ACCESSORIES

AIRSTREAM SPARE PARTS



1 Z1997RK Replacement sliding screen Airstream

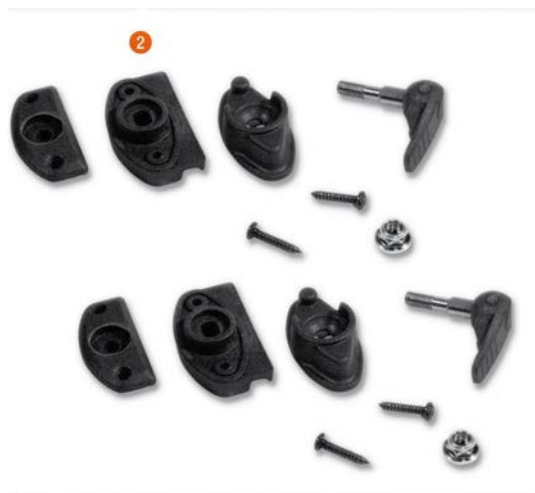

2 Z1963R Airstream guide latch spare parts

BOLT AND SCREWS KITS FOR K / KZ

1101KIT	1101KITFR	Bolts and screws kit 1101KIT
1102KIT	1102KITFR	Bolts and screws kit 1102KIT
1104KIT	1104KITFR	Bolts and screws kit 1104KIT
1109KIT	1109KITFR	Bolts and screws kit 1109KIT
1111KIT	1111KITFR	Bolts and screws kit 1111KIT
1121KIT	1121KITFR	Bolts and screws kit 1121KIT
1137KIT	1137KITFR	Bolts and screws kit 1137KIT
2110KIT	2110KITFR	Bolts and screws kit 2110KIT
2118KIT	2118KITFR	Bolts and screws kit 2118KIT
219DKIT	D219KITR	Bolts and screws kit 219DKIT
267KIT	267KITFR	Bolts and screws kit 267KIT
3100KIT	3100KITFR	Bolts and screws kit 3100KIT
351KIT	351KITFR	Bolts and screws kit 351KIT
365KIT	365KITFR	Bolts and screws kit 365KIT
366KIT	366KITFR	Bolts and screws kit 366KIT
4100KIT	4100KITFR	Bolts and screws kit 4100KIT
4107KIT	4107KITFR	Bolts and screws kit 4107KIT
4108KIT	4108KITFR	Bolts and screws kit 4108KIT
4109KIT	4109KITFR	Bolts and screws kit 4109KIT
450KIT	450KITFR	Bolts and screws kit 450KIT
642F	642KITR	Bolts and screws kit 642F
7400KIT	7400KITFR	Bolts and screws kit 7400KIT
777KIT	KIT777R	Bolts and screws kit 777KIT
K1200	1000KITR	Bolts and screws kit K1200
K2480	248KITR	Bolts and screws kit K2480
K2520	252KITR	Bolts and screws kit K2520
K3400	340KITR	Bolts and screws kit K3400
K5220	522KITR	Bolts and screws kit K5220
KZ1102	1102FZKITR	Bolts and screws kit KZ1102
KZ1104	1104FZKITR	Bolts and screws kit KZ1104
KZ1111- KZ1109	1109FZKITR	Bolts and screws kit KZ1111-KZ1109

KZ1121	1121FZKITR	Bolts and screws kit KZ1121
KZ162	162FZKITR	Bolts and screws kit KZ162
KZ166	166FZKITR	Bolts and screws kit KZ166
KZ256	256FZKITR	Bolts and screws kit KZ256
KZ257	257FZKITR	Bolts and screws kit KZ257
KZ258	258FZKITR	Bolts and screws kit KZ258
KZ260	260FZKITR	Bolts and screws kit KZ260
KZ263	263FZKITR	Bolts and screws kit KZ263
KZ267	267FZKITR	Bolts and screws kit KZ267
KZ348	348FZKITR	Bolts and screws kit KZ348
KZ351	351FZKITR	Bolts and screws kit KZ351
KZ356	356FZKITR	Bolts and screws kit KZ356
KZ359	359FZKITR	Bolts and screws kit KZ359
KZ364	364FZKITR	Bolts and screws kit KZ364
KZ366	366FZKITR	Bolts and screws kit KZ366
KZ4100	4100FZKITR	Bolts and screws kit KZ4100
KZ4104	4104FZKITR	Bolts and screws kit KZ4104
KZ445	445FZKITR	Bolts and screws kit KZ445
KZ447	447FZKITR	Bolts and screws kit KZ447
KZ448	448FZKITR	Bolts and screws kit KZ448
KZ449	449FZKITR	Bolts and screws kit KZ449
KZ451	451FZKITR	Bolts and screws kit KZ451
KZ529	529FZKITR	Bolts and screws kit KZ529
KZ539	534FZKITR	Bolts and screws kit KZ539
KZ1127	1127FZKITR	Bolts and screws kit KZ1127
KZ1131	1131FZKITR	Bolts and screws kit KZ1131
KZ1132	1132FZKITR	Bolts and screws kit KZ1132
KZ1137	1137FZKITR	Bolts and screws kit KZ1137
KZ2115	2115FZKITR	Bolts and screws kit KZ2115
KZ2118	2118FZKITR	Bolts and screws kit KZ2118

BOLT AND SCREWS KITS FOR KR / KRA

KR104	104SRKITR	Bolts and screws kit KR104
KR105	105SRKITR	Bolts and screws kit KR105
KR107	107SRKITR	Bolts and screws kit KR107
KR1103	1103SRKITR	Bolts and screws kit KR1103
KR1106	1106SRKITR	Bolts and screws kit KR1106
KR1110	1110SRKITR	Bolts and screws kit KR1110
KR1118	1118SRKITR	Bolts and screws kit KR1118
KR1125	1125SRKITR	Bolts and screws kit KR1125
KR115	115SRKITR	Bolts and screws kit KR115
KR116M-KR116	116SRKITR	Bolts and screws kit KR116M-KR116
KR117M	117SRMKITR	Bolts and screws kit KR117M
KR1134	1134SRKITR	Bolts and screws kit KR1134
KR1180	118SRKITR	Bolts and screws kit KR1180
KR126	126SRKITR	Bolts and screws kit KR126
KR134M-KR134	134SRKITR	Bolts and screws kit KR134M-KR134
KR140	140SRKITR	Bolts and screws kit KR140
KR1570	157SRKITR	Bolts and screws kit KR1570
KR19	19SRKITR	Bolts and screws kit KR19
KR1119	1119SRKITR	Bolts and screws kit KR1119
KR1123-KR1123MM	1123SRKITR	Bolts and screws kit KR1123-KR1123MM
KR2013	2013SRKITR	Bolts and screws kit KR2013
KR369	369SRKITR	Bolts and screws kit KR369
KR225	225SRKITR	Bolts and screws kit KR225
KR2111	2111SRKITR	Bolts and screws kit KR2111
KR2111M	2111SRMKITR	Bolts and screws kit KR2111M
KR2117	2117SRKITR	Bolts and screws kit KR2117
KR2117M	2117SRMKITR	Bolts and screws kit KR2117M
KR2120	2120SRKITR	Bolts and screws kit KR2120
KR2121	2121SRKITR	Bolts and screws kit KR2121
KR2330	233SRMKITR	Bolts and screws kit KR2330
KR3101	3101SRKITR	Bolts and screws kit KR3101
KR3101M	3101SRMKITR	Bolts and screws kit KR3101M
KR3104	3104SRKITR	Bolts and screws kit KR3104
KR3105	3105SRKITR	Bolts and screws kit KR3105
KRA3105	3105SRAKITR	Bolts and screws kit KRA3105
KR3106	3106SRKITR	Bolts and screws kit KR3106
KR312	312SRKITR	Bolts and screws kit KR312
KR354	354SRKITR	Bolts and screws kit KR354
KR3550	355SRMKITR	Bolts and screws kit KR3550

KR357	357SRKITR	Bolts and screws kit KR357
KR365M	365SRMKITR	Bolts and screws kit KR365M
KR371	371SRKITR	Bolts and screws kit KR371
KR372	372SRKITR	Bolts and screws kit KR372
KR4111-KR4111M	4111SRKITR	Bolts and screws kit KR4111/KR4111M
KR4105	4105SRKITR	Bolts and screws kit KR4105
KR44M	44SRMKITR	Bolts and screws kit KR44M
KR45	45SRKITR	Bolts and screws kit KR45
KR56	56SRKITR	Bolts and screws kit KR56
KR5600M	5600SRMKITR	Bolts and screws kit KR5600M
KR5108	5108SRKITR	Bolts and screws kit KR5108
KR5607	5607SRKITR	Bolts and screws kit KR5607
KR5609-KR5609M	5609SRKITR	Bolts and screws kit KR5609-KR5609M
KR6104	6104SRKITR	Bolts and screws kit KR6104
KR6104M	6104SRMKITR	Bolts and screws kit KR6104M
KR6106	6106SRKITR	Bolts and screws kit KR6106
KR6401	6401SRKITR	Bolts and screws kit KR6401
KR6404	6404SRKITR	Bolts and screws kit KR6404
KRA6404	6404SRAKITR	Bolts and screws kit KRA6404
KR6105	6105SRKITR	Bolts and screws kit KR6105
KR6701	6701SRKITR	Bolts and screws kit KR6701
KR684	684SRKITR	Bolts and screws kit KR684
KR685	685SRKITR	Bolts and screws kit KR685
KR689	689SRKITR	Bolts and screws kit KR689
KR740	740SRKITR	Bolts and screws kit KR740
KRA7403	7403SRAKITR	Bolts and screws kit KRA7403
KR7703	7703SRKITR	Bolts and screws kit KR7703
KRA7703	7703SRAKITR	Bolts and screws kit KRA7703
KR777	777SRKITR	Bolts and screws kit KR777
KR86	86SRKITR	Bolts and screws kit KR86
KR8701-KR8701M	8701SRKITR	Bolts and screws kit KR8701-KR8701M
KR90	90SRKITR	Bolts and screws kit KR90
KR910	91SRMKITR	Bolts and screws kit KR910
KR92	92SRKITR	Bolts and screws kit KR92
KR920	92SRMKITR	Bolts and screws kit KR920
KRA5108	5108SRAKITR	Bolts and screws kit KRA5108
KRA5113	5113SRAKITR	Bolts and screws kit KRA5113
KRA6706	6706SRAKITR	Bolts and screws kit KRA6706

📌 = Item available until it runs out of stock



MOTORCYCLE ACCESSORIES

BOLT AND SCREWS KITS FOR PLATES

K213	E213KITR	Bolts and screws kit K213
K222	222EKITR	Bolts and screws kit K222
K225M-K225	225EKITR	Bolts and screws kit K225M-K225
K2480-K1200-642F	1FR	Bolts and screws kit K2480-K1200-642F
K28	128KITR	Bolts and screws kit K28
K331M-K331	331EKITR	Bolts and screws kit K331M-K331
K528	528EKITR	Bolts and screws kit K528
K528M	528EMKITR	Bolts and screws kit K528M
K529M	529EMKITR	Bolts and screws kit K529M
K529M-K529	529EKITR	Bolts and screws kit K529M-K529
K531M-K531E	531EKITR	Bolts and screws kit K531M-K531E
K581	581EKITR	Bolts and screws kit K581
K611-K604-K603	K611KITR	Bolts and screws kit K611-K604-K603
K633-K632	95ESKITR	Bolts and screws kit K633-K632

K682M	680EKITR	Bolts and screws kit K682M
K682M	682EKITR	Bolts and screws kit K682M
K81	181KITR	Bolts and screws kit K81
K93	193EKITR	Bolts and screws kit K93
K94M	194EMKITR	Bolts and screws kit K94M
K94M-K94	194EKITR	Bolts and screws kit K94M-K94
K9913-K9912	E96KITR	Bolts and screws kit K9913-K9912
K9914	120EKITR	Bolts and screws kit K9914
KE2230	223EKITR	Bolts and screws kit KE2230
KE2310	231EKITR	Bolts and screws kit KE2310
KE3411	E341KITR	Bolts and screws kit KE3411
KE3420	342EKITR	Bolts and screws kit KE3420
KE3440	344EKITR	Bolts and screws kit KE3440
KE3490	349EKITR	Bolts and screws kit KE3490

BOLT AND SCREWS KITS FOR KL / KLR / KLX / KLXR

K8127	127YKITR	Bolts and screws kit K8127
KL131	131PLKITR	Bolts and screws kit KL131
KL167	167PLKITR	Bolts and screws kit KL167
KL170	164PLKITR	Bolts and screws kit KL170
KL174	174PLKITR	Bolts and screws kit KL174
KL188	188PLKITR	Bolts and screws kit KL188
KL203	203PLKITR	Bolts and screws kit KL203
KL1121	1121PLKITR	Bolts and screws KL1121
KL3101	3101PLKITR	Bolts and screws kit KL3101
KL3103	3103PLKITR	Bolts and screws kit KL3103
KL347	347PLKITR	Bolts and screws kit KL347
KL367	367PLKITR	Bolts and screws kit KL367
KL448	448PLKITR	Bolts and screws kit KL448
KL528	528PLKITR	Bolts and screws kit KL528
KL532	532PLKITR	Bolts and screws kit KL532
KL650	650PLKITR	Bolts and screws kit KL650
KL684	684PLKITR	Bolts and screws kit KL684
KL685	685PLKITR	Bolts and screws kit KL685
KL690	690PLKITR	Bolts and screws kit KL690
KL6706	6706PLKITR	Bolts and screws kit KL6706
KLR367	367PLRKITR	Bolts and screws kit KLR367
KL2119	2119PLKITR	Bolts and screws kit KL2119
KLR2119	2119PLRKITR	Bolts and screws kit KLR2119
KLR4105	4105PLRKITR	Bolts and screws kit KLR4105
KLR5108	5108PLRKITR	Bolts and screws kit KLR5108
KLR5109	5109PLRKITR	Bolts and screws kit KLR5109
KLR6401	6401PLRKITR	Bolts and screws kit KLR6401

6404KIT	6404KITFR	Bolts and screws kit 6404KIT
KLR6404	6404PLRKITR	Bolts and screws kit KLR6404
KLR7703	7703PLRKITR	Bolts and screws kit KLR7703
KLX1109	1109PLXKITR	Bolts and screws kit KLX1109
KLX1111-KL1111	1111PLKITR	Bolts and screws kit KLX1111-KL1111
KLX1120	1120PLXKITR	Bolts and screws kit KLX1120
KLX1121	1121PLXKITR	Bolts and screws kit KLX1121
KLX347	347PLXKITR	Bolts and screws kit KLX347
KLX4104	4104PLXKITR	Bolts and screws kit KLX4104
KLX449	449PLXKITR	Bolts and screws kit KLX449
KLX532	532PLXKITR	Bolts and screws kit KLX532
KLXR2110	2110PLXKITR	Bolts and screws kit KLXR2110
KLXR364	364PLXKITR	Bolts and screws kit KLXR364
KLXR366	366PLXKITR	Bolts and screws kit KLXR366
KLXR4105	4105PLXKITR	Bolts and screws kit KLXR4105
KLXR450-KLR450	450PLRKITR	Bolts and screws kit KLXR450-KLR450
PLX174KIT	174KITPLXR	Bolts and screws kit PLX174KIT
PLX359KIT	359KITPLXR	Bolts and screws kit PLX359KIT
PLX447KIT	447KITPLXR	Bolts and screws kit PLX447KIT
PLX449KIT	449KITPLXR	Bolts and screws kit PLX449KIT
KLX539	539PLXKITR	Bolts and screws kit KLX539
KL3104	3104PLKITR	Bolts and screws kit KL3104
KLX1127	1127PLXKITR	Bolts and screws kit PLX1127
KL8701	8701PLKITR	Bolts and screws kit KL8701
KLX1137	1137PLXKITR	Bolts and screws kit PLX1137

BOLT AND SCREWS KITS FOR TE__K / TK/BF__K

7400KIT	681KITR	Bolts and screws kit 7400KIT
T265KIT	265KITR	Bolts and screws kit T265KIT
T267KIT	267KITR	Bolts and screws kit T267KIT
T700KIT	700TKITR	Bolts and screws kit T700KIT
T704	704TKITR	Bolts and screws kit T704
TE1101K	1101TEKTR	Bolts and screws kit TE1101K
TE1137K	1137TEKTR	Bolts and screws kit TE1137K
TE2110K	2110TEKTR	Bolts and screws kit TE2110K
TE2115K	2115TEKTR	Bolts and screws kit TE2115K
TE5111K	5111TEKTR	Bolts and screws kit TE5111K
TE7404K	7404TEKTR	Bolts and screws kit TE7404K
1127KIT	1127KITR	Bolts and screws kit 1127KIT
2115KIT	2115KITR	Bolts and screws kit 2115KIT
2118KIT	2118KITR	Bolts and screws kit 2118KIT
TK213	213TKITR	Bolts and screws kit TK213
TK214	214TKITR	Bolts and screws kit TK214

TK216	216TKITR	Bolts and screws kit TK216
TK218	218TKITR	Bolts and screws kit TK218
TK220	220TKITR	Bolts and screws kit TK220
TK223	223TKITR	Bolts and screws kit TK223
TK264	264TKITR	Bolts and screws kit TK264
TK273	273TKITR	Bolts and screws kit TK273
TK276	276TKITR	Bolts and screws kit TK276
TK351	351TKITR	Bolts and screws kit TK351
BF16K	16BFKITR	Bolts and screws kit BF16K
BF17K	17BFKITR	Bolts and screws kit BF17K
BF18K	18BFKITR	Bolts and screws kit BF18K
BF19K	19BFKITR	Bolts and screws kit BF19K
BF20K	20BFKITR	Bolts and screws kit BF20K
BF21K	21BFKITR	Bolts and screws kit BF21K
TE5115K	5115TEKTR	Bolts and screws kit TE5115K

BOLT AND SCREWS KITS FOR SCREENS

115KIT	115KITR	Bolts and screws kit 115KIT
305A	305AKITR	Bolts and screws kit 305A
A103A	103AKITR	Bolts and screws kit A103A
A104A	104AKITR	Bolts and screws kit A104A
A106A	106AKITR	Bolts and screws kit A106A
A107A	110AKITR	Bolts and screws kit A107A
A1100A	1100AKITR	Bolts and screws kit A1100A
A1101A	1101AKITR	Bolts and screws kit A1101A
A1106A	1106AKITR	Bolts and screws kit A1106A
A1114A	1114AKITR	Bolts and screws kit A1114A
A1125A	1125AKITR	Bolts and screws kit A1125A
A1126A	1126AKITR	Bolts and screws kit A1126A
A129A	129AKITR	Bolts and screws kit A129A
A132A	132AKITR	Bolts and screws kit A132A
A137A	137AKITR	Bolts and screws kit A137A
A147A	147AKITR	Bolts and screws kit A147A
A148A	148AKITR	Bolts and screws kit A148A
A150A	150AKITR	Bolts and screws kit A150A
A151A	151AKITR	Bolts and screws kit A151A
A154A	154AKITR	Bolts and screws kit A154A
A167A	167AKITR	Bolts and screws kit A167A
A169A	169AKITR	Bolts and screws kit A169A
A170A	170AKITR	Bolts and screws kit A170A
A183A	183AKITR	Bolts and screws kit A183A
A185A	185AKITR	Bolts and screws kit A185A
A186A	186AKITR	Bolts and screws kit A186A
A2115	2115AKITR	Bolts and screws kit A2115

A2102A	2102AKITR	Bolts and screws kit A2102A
A257A	257AKITR	Bolts and screws kit A257A
A259A- A152A	152AKITR	Bolts and screws kit A259A-A152A
A281A	281AKITR	Bolts and screws kit A281A
A283A	283AKITR	Bolts and screws kit A283A
A284A	284AKITR	Bolts and screws kit A284A
A285A	285AKITR	Bolts and screws kit A285A
A288A	288AKITR	Bolts and screws kit A288A
A289A	289AKITR	Bolts and screws kit A289A
A295A	295AKITR	Bolts and screws kit A295A
A297A	297AKITR	Bolts and screws kit A297A
A299A	299AKITR	Bolts and screws kit A299A
A303A	303AKITR	Bolts and screws kit A303A
A307A	307AKITR	Bolts and screws kit A307A
A311A	311AKITR	Bolts and screws kit A311A
A312A	312AKITR	Bolts and screws kit A312A
A314A	314AKITR	Bolts and screws kit A314A
A315A	315AKITR	Bolts and screws kit A315A
A352A	352AKITR	Bolts and screws kit A352A
A357A	357AKITR	Bolts and screws kit A357A
A358A	358AKITR	Bolts and screws kit A358A
A440A	440AKITR	Bolts and screws kit A440A
A442A	442AKITR	Bolts and screws kit A442A
A443A	443AKITR	Bolts and screws kit A443A
A445A	445AKITR	Bolts and screws kit A445A
A448A	448AKITR	Bolts and screws kit A448A
A5100A	5100AKITR	Bolts and screws kit A5100A

MOTORCYCLE ACCESSORIES

A5602A	5602AKITR	Bolts and screws kit A5602A
A5603A	5603AKITR	Bolts and screws kit A5603A
A5607A	5607AKITR	Bolts and screws kit A5607A
A5608A	5608AKITR	Bolts and screws kit A5608A
A6102A	6102AKITR	Bolts and screws kit A6102A
A6106A	6106AKITR	Bolts and screws kit A6106A
A642A	642AKITR	Bolts and screws kit A642A
A7050A-A298A	298AKITR	Bolts and screws kit A7050A-A298A
A7701A	7701AKITR	Bolts and screws kit A7701A
A7702A	7702AKITR	Bolts and screws kit A7702A
A781A	781AKITR	Bolts and screws kit A781A
A850A	850AKITR	Bolts and screws kit A850A
A8100A	8100AKITR	Bolts and screws kit A8100A
A9100A	9100AKITR	Bolts and screws kit A9100A
AS100A2	100ASKITR	Bolts and screws kit AS100A2
AS102A2	102ASKITR	Bolts and screws kit AS102A2
AS103A2	103ASKITR	Bolts and screws kit AS103A2
AS121A2	121ASKITR	Bolts and screws kit AS121A2
AS122A2	122ASKITR	Bolts and screws kit AS122A2
AS128A2	128ASKITR	Bolts and screws kit AS128A2
AS300A2	300ASKITR	Bolts and screws kit AS300A2
D1105KIT	1105DKITR	Bolts and screws kit D1105KIT
D140KIT	140DKITR	Bolts and screws kit D140KIT
D214KIT	214DKITR	Bolts and screws kit D214KIT
D266KIT	266DKITR	Bolts and screws kit D266KIT
D267KIT	267DKITR	Bolts and screws kit D267KIT
D290KIT	290DKITR	Bolts and screws kit D290KIT
D292KIT	292DKITR	Bolts and screws kit D292KIT
D315KIT	315DKITR	Bolts and screws kit D315KIT
D340KIT	340DKITR	Bolts and screws kit D340KIT
D402KIT	402DKITR	Bolts and screws kit D402KIT
D408KIT	408DKITR	Bolts and screws kit D408KIT
D440KIT	440DKITR	Bolts and screws kit D440KIT
D445KIT	445DKITR	Bolts and screws kit D445KIT
D446KIT	446DKITR	Bolts and screws kit D446KIT
D7051KIT	7051DKITR	Bolts and screws kit D7051KIT
K621-K612-E109S	E84KITR	Bolts and screws kit K621-K612-E109S
KA1137	1137AKITR	Bolts and screws kit KA1137
KA2118	2118AKITR	Bolts and screws kit KA2118
KA4104-D317KIT	1102AKITR	Bolts and screws kit KA4104-D317KIT
KA446	446AKITR	Bolts and screws kit KA446
KA7404	7404AKITR	Bolts and screws kit KA7404
KA8701	8701AKITR	Bolts and screws kit KA8701
KAF3101	3101KITR	Bolts and screws kit KAF3101
KAF330-D330KIT	330DKITR	Bolts and screws kit KAF330-D330KIT
KAF5107	5107DKITR	Bolts and screws kit KAF5107
KAF5600-D5600KIT	5600DKITR	Bolts and screws kit KAF5600-D5600KIT
KAF6401-D6401KIT	6401DKITR	Bolts and screws kit KAF6401-D6401KIT
KD5109ST-KD5109S	5109DKITR	Bolts and screws kit KD5109ST-KD5109S
KD6104ST	6104DKITR	Bolts and screws kit KD6104ST
KD7703ST	7703DKITR	Bolts and screws kit KD7703ST
D5108KIT	5108DKITR	Bolts and screws kit D5108KIT
D2111KIT	2111DKITR	Bolts and screws kit D2111KIT
A2114A	2114AKITR	Bolts and screws kit A2114A

BOLT AND SCREWS KITS FOR ENGINE GUARDS/ OIL CARTER PROTECTOR / BACKRESTS

KMG1127	1127MGKITR	Bolts and screws kit KMG1127
KMG3101-KMG532	3101MGKITR	Bolts and screws kit KMG3101-KMG532
KMG5103	5103MGKITR	Bolts and screws kit KMG5103
KMG4103	4103MGKITR	Bolts and screws kit KMG4103
KMG6401	6401MGKITR	Bolts and screws kit KMG6401
KN1110	1110TNKITR	Bolts and screws kit KN1110
KN11100X	1110TNOXKITR	Bolts and screws kit KN11100X
KN1111	1111TNKITR	Bolts and screws kit KN1111
KN2105	2105TNKITR	Bolts and screws kit KN2105
KN22	363TNKITR	Bolts and screws kit KN22
KN23	362TNKITR	Bolts and screws kit KN23
KN25	365TNKITR	Bolts and screws kit KN25
KN26	366TNKITR	Bolts and screws kit KN26
KN28	367TNKITR	Bolts and screws kit KN28
KN3101	3101TNKITR	Bolts and screws kit KN3101
KN34	347TNKITR	Bolts and screws kit KN34
KN355	355TNKITR	Bolts and screws kit KN355
KN359	359TNKITR	Bolts and screws kit KN359
KN369	369TNKITR	Bolts and screws kit KN369
KN4105	4105TNKITR	Bolts and screws kit KN4105
KN421	421TNKITR	Bolts and screws kit KN421
KN422	422TNKITR	Bolts and screws kit KN422
KN454	454TNKITR	Bolts and screws kit KN454
KN455	455TNKITR	Bolts and screws kit KN455
KN456	456TNKITR	Bolts and screws kit KN456
KN46	528TNKITR	Bolts and screws kit KN46
KN460	460TNKITR	Bolts and screws kit KN460
KN5108OX - KN5108	5108TNKITR	Bolts and screws KN5108OX - KN5108
KNH5108 - KNH5108OX	5108TNHKITR	Bolts and screws KNH5108 - KNH5108OX

KNS1100X	5110TNOXKTR	Bolts and screws KNS1100X
KNH5114	5114TNHKTR	Kit Visserie KNH5114
KNH51140X	5114TNHOXKTR	Kit Visserie KNH51140X
KN532	532TNKTR	Bolts and screws kit KN532
KN6404	6404TNKTR	Bolts and screws kit KN6404
KN689	689TNKTR	Bolts and screws kit KN689
KN690	690TNKTR	Bolts and screws kit KN690
KN7703	7703TNKTR	Bolts and screws kit KN7703
KTB2111	2111TBKTR	Bolts and screws kit KTB2111
KTB48	TB48KTR	Bolts and screws kit KTB48
KTB49	TB49KTR	Bolts and screws kit KTB49
KTB82	TB82KTR	Bolts and screws kit KTB82
KTB2120	2120TBKTR	Bolts and screws kit KTB2120
KTB3106	3106TBKTR	Bolts and screws kit KTB3106
KTB4111	4111TBKTR	Bolts and screws kit KTB4111

KTB6104	6104TBKTR	Bolts and screws kit KTB6104
RP1110	1110RPKTR	Bolts and screws kit RP1110
RP2101	2101RPKTR	Bolts and screws kit RP2101
RP2105	2105RPKTR	Bolts and screws kit RP2105
RP2119	2119RPKTR	Bolts and screws kit RP2119
RP3101	3101RPKTR	Bolts and screws kit RP3101
RP3105	3105RPKTR	Bolts and screws kit RP3105
RP5103	5103RPKTR	Bolts and screws kit RP5103
RP6401	6401RPKTR	Bolts and screws kit RP6401
RP6403	6403RPKTR	Bolts and screws kit RP6403
RP7703	7703RPKTR	Bolts and screws kit RP7703
RP5108	5108RPKTR	Bolts and screws kit RP5108
RP5112	5112RPKTR	Bolts and screws kit RP5112
KNH51120X	5112TNHKTR	Bolts and screws kit KNH51120X
KN3105	3105TNKTR	Bolts and screws kit KN3105

BOLT AND SCREWS KITS FOR ACCESSORIES

PARTI STANDARD	1FR	Bolts and screws kit PARTI STANDARD
K633-K632	95ESKTR	Bolts and screws kit K633-K632
K9914	120EKTR	Bolts and screws kit K9914
KS650	650SKTR	Bolts and screws kit KS650
ES5108K	5108ESKTR	Bolts and screws kit ES5108K
ES4103K	4103ESKTR	Bolts and screws kit ES4103K
ES1110K	1110ESKTR	Bolts and screws kit ES1110K
ES1121K	1121ESKTR	Bolts and screws kit ES1121K
ES2105K	2105ESKTR	Bolts and screws kit ES2105K
ES2119K	2119ESKTR	Bolts and screws kit ES2119K
ES7703K	7703ESKTR	Bolts and screws kit ES7703K
ES3101K	3101ESKTR	Bolts and screws kit ES3101K
ES3105K	3105ESKTR	Bolts and screws kit ES3105K
ES6706K	6706ESKTR	Bolts and screws kit ES6706K

ES5102K	5102ESKTR	Bolts and screws kit ES5102K
ES6401K	6401ESKTR	Bolts and screws kit ES6401K
ES6403K	6403ESKTR	Bolts and screws kit ES6403K
ES5101K	5101ESKTR	Bolts and screws kit ES5101K
ES5107K	5107ESKTR	Bolts and screws kit ES5107K
ES5112K	5112ESKTR	Bolts and screws kit ES5112K
ES5113K	5113ESKTR	Bolts and screws kit ES5113K
ES7704K	7704ESKTR	Bolts and screws kit ES7704K
LP5112	5112LPKTR	Bolts and screws kit LP5112
KHP1111	1111HPKTR	Bolts and screws kit KHP1111
KHP1121	1121HPKTR	Bolts and screws kit KHP1121
KHP2115	2115HPKTR	Bolts and screws kit KHP2115
KHP3105	3105HPKTR	Bolts and screws kit KHP3105
KHP4103	4103HPKTR	Bolts and screws kit KHP4103
KHP5103	5103HPKTR	Bolts and screws kit KHP5103

MOUNTING POSSIBILITIES

In order to fix a case or top-case on your motorcycle/scooter, KAPPA offers lots of possibilities depending on the model of motorcycle you own. Herewith following you will find all the fitting possibilities; you can look at the table "Guide to the availability for motorcycle models" to see which is the best solution in your case.

MONOKEY® CASES RANGE



A - MOUNTING POSSIBILITIES { 1 MONOKEY TOP-CASE }

MONORACK (K / K...L TYPE)

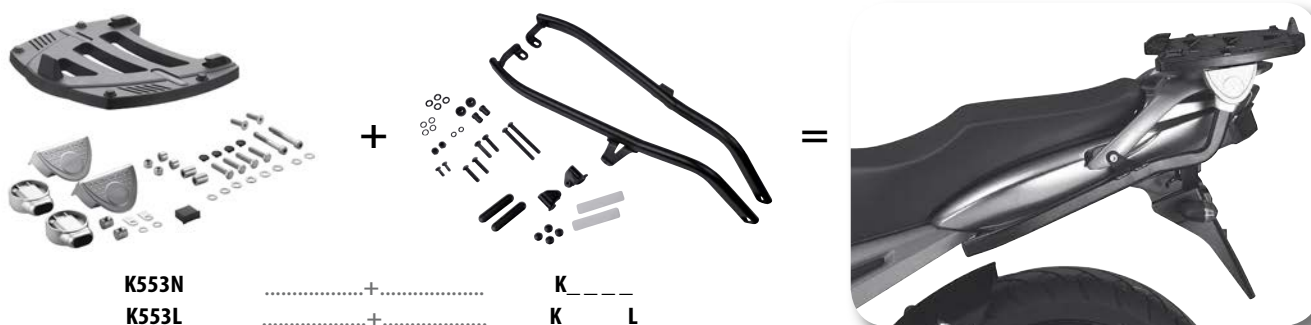

MONORACK (KZ TYPE)

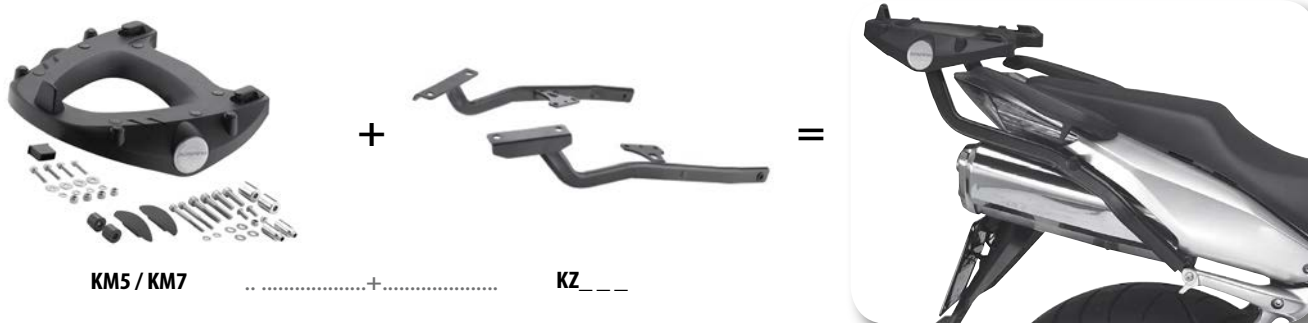

SPECIAL RACK (KR TYPE)



SPECIFIC ALUMINIUM PLATE (KRA TYPE)

For MONOKEY® cases



KRA ____

It does not allow the assembly of the stop light kit or the remote control device on the case



SPECIFIC PLATE (K TYPE)



K ____



with the plate you find in the box



B - MOUNTING POSSIBILITIES { 2 MONOKEY SIDE TOP-CASE }

Monokey® cases suggested by KAPPA for the lateral mounting: K21N - K22N - K40

SPECIFIC TUBULAR SIDE CASE HOLDER (KL TYPE)

KL ____
o

KLR ____ (Specific rapid attachment /release)



MOUNTING POSSIBILITIES

{ C - 3 MONOKEY® TOP-CASE }

{ D - 2 MONOKEY® TOP-CASE + 1 MONOLOCK® TOP-CASE }

Monokey® cases suggested by KAPPA for the lateral mounting: K21N - K22N - K40

MONORACK (K/KZ/KL TYPE) + SPECIFIC TUBULAR SIDE CASE HOLDER (KL TYPE)



K / KZ

+

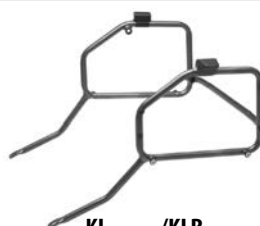

KL ____ /KLR

=



With KZ: + KM5 / KM11 plate for the mounting of Monokey® top-case / + KM5M plate for the mounting of the Monolock® top-case
With K: + KS53N for the mounting of Monokey® top-case / + MKN plate for the mounting of Monolock® top-case

WINGRACK SYSTEM IN ALLUMINIUM (K140/K141 TYPE)



K140

K141

+



K8 ____

=

Wingrack K140 / K141



MOUNTING POSSIBILITIES

MONOLOCK® CASES RANGE



A - MOUNTING POSSIBILITIES {1 MONOLOCK® TOP-CASE }

MONORACK (K TYPE)

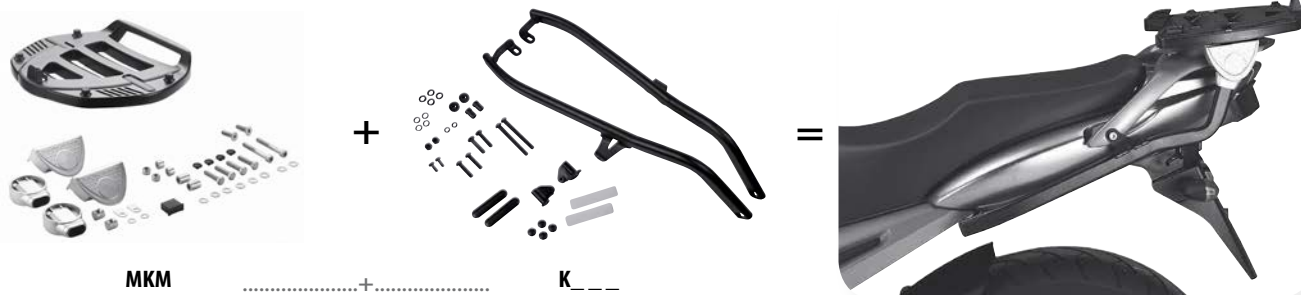

MONORACK (KZ TYPE)



SPECIFIC PLATE (KR TYPE)



SPECIFIC PLATE (KE TYPE)

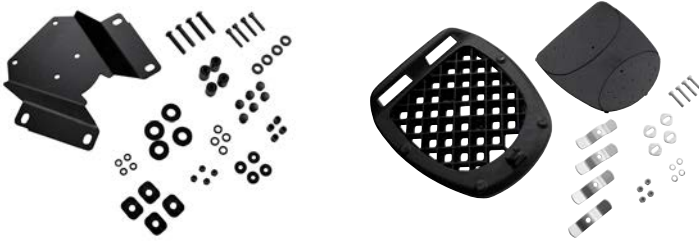

KE ___ + ___ with the Monolock® plate you find in the box



MONOKEY® SIDE CASES RANGE



K33N K-ROAD

MOUNTING POSSIBILITIES {A - 2 MONOKEY® SIDE CASES}
{B - 2 MONOKEY® SIDE CASES + 1 MONOKEY® CASE OR 1 MONOLOCK® CASE}

TUBULAR SIDE-CASE HOLDERS (KLX)

TUBULAR SIDE-CASE HOLDERS RAPID FITTING (KLXR)



KLX ___ / KLXR ___



MONORACK (K/KZ TYPE) + TUBULAR SIDE-CASE HOLDER (KLX/KLXR TYPE)



K / KZ

+



KLX ___ / KLXR ___

=



*With KZ: + KMS / KM7 plate for the mounting of Monokey® top-case / + KMSM plate for the mounting of Monolock® top-case
With K: + K53N for the mounting of Monokey® top-case / + MKN plate for the mounting of Monolock® top-case*

MOUNTING POSSIBILITIES

MOUNTING POSSIBILITIES with UNIVERSAL SYSTEMS

If there has not been a specific solution for the mounting of KAPPA cases and top-cases for your motorcycle, you can also check the possibility of using one of the following universal fitting systems:

A - MOUNTING POSSIBILITIES (1 MONOKEY® TOP-CASE)

UNIVERSAL MONORACK (K1200) / UNIVERSAL PLATE (K636)

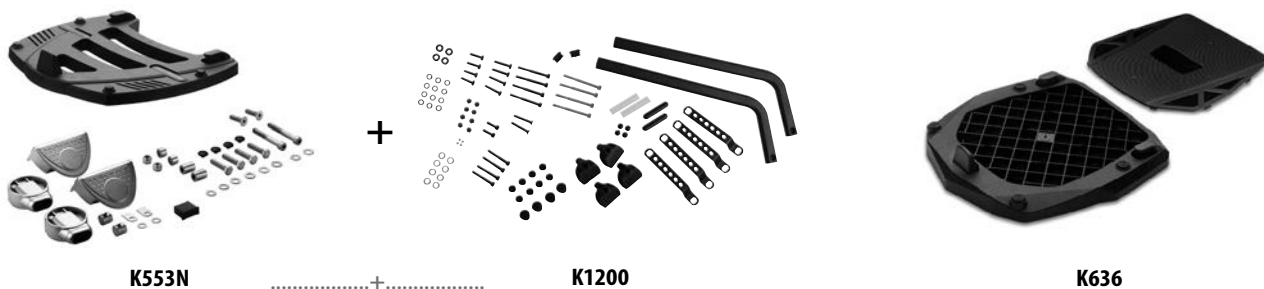

B - MOUNTING POSSIBILITIES (3 MONOKEY® CASES)

UNIVERSAL FITTING KIT (K8127)

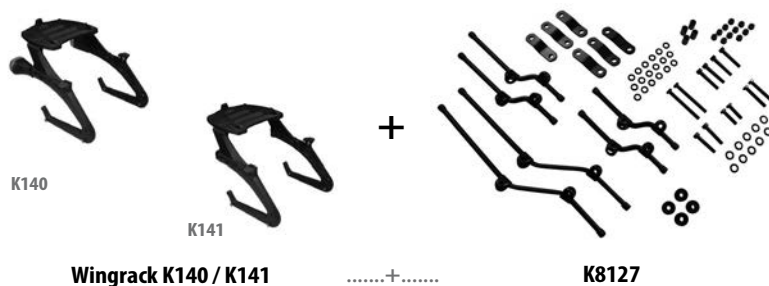

C - MOUNTING POSSIBILITIES (1 MONOLOCK® CASE)

UNIVERSAL MONORACK (K1200) / UNIVERSAL PLATE (K636)

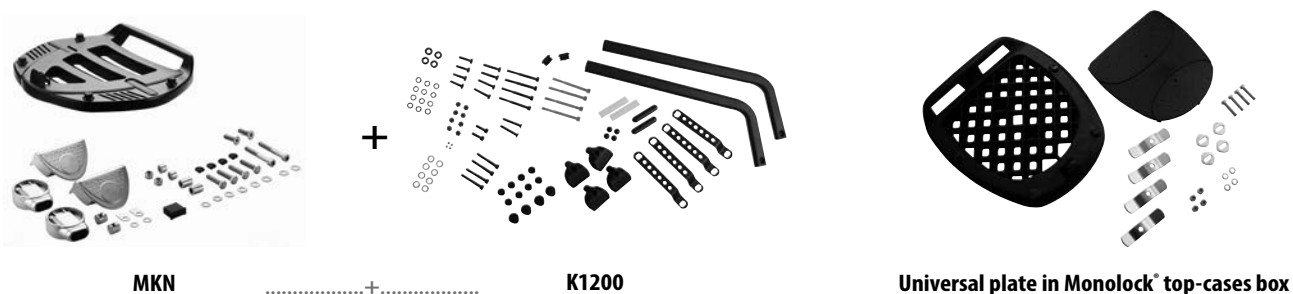



In any case.

GENERAL CONDITIONS OF SALE

- 1. Scope**
- 1.1** The conditions below apply to the supply of goods and other services by KAPPA srl.
- 1.2** These terms of business apply exclusively; any buyer conditions that conflict with or differ from these terms of business will not be recognized unless KAPPA srl has specifically agreed to this in writing.
- 2. Orders and Specifications**
- 2.1** The range shown on KAPPA srl's web-site, web-order system and KAPPA srl's printed catalogue does not represent a legally binding offer but a non-binding online catalogue or printed catalogue.
- 2.2** The buyer will order the goods or services required by accessing the reserved web-order area or via fax / E-Mail. No order submitted by the buyer shall be deemed to be accepted by KAPPA srl unless and until confirmed in writing by KAPPA srl.
- 2.3** Any purchase order placed by the buyer shall be intended as full and complete acceptance of the present Terms and Conditions of Sale that the customer declares to have read and understood.
- 2.4** KAPPA srl reserves the right to refuse an order fully or partially according to stock availability, production capability and delivery date required by the customer.
- 3. Price, Invoice, payment,**
- 3.1** All prices are in euro (VAT is not due, therefore not included) and can be subject to alteration with 15 days prior notice from KAPPA srl. All prices are intended for goods delivered EX-WORKS "Incoterms" ICC 2010 (from our warehouse in Barbariga).
- 3.2** Invoices must be paid within their expiry date.
- In case one or more invoices are expired and unpaid, or the maximum exposure limit is reached or exceeded, KAPPA srl shall be entitled to suspend any further deliveries to the buyer until the overdue payment is received in full (payments received need to be confirmed by KAPPA srl's Bank, when credited on KAPPA srl's bank account).
- 3.3** In case of delayed payment or non-payment, KAPPA srl is entitled to apply commercial interest on arrears as per "Decreto legislativo 231/2002" (Legislative Decree 231/2002 as per the Italian law) and expenses at the bank rates in-force from time to time.
- 4. Packaging and shipment**
- 4.1** A packaging cost contribution is charged by KAPPA srl in each invoice and calculated based on the number of cartons needed to contain and protect the goods during the transportation.
- 4.2** Shipments are not prepared on pallets unless specifically requested by the buyer. The cost of the pallets, if used, is charged by KAPPA srl on the invoice to the buyer.
- 5. Transportation**
- 5.1** Buyer and KAPPA agree and acknowledge that the place of delivery of the goods is at the KAPPA logistic centre in Barbariga (BS), Italy
- 5.2** No claim for missing or damaged goods can be accepted by KAPPA srl past eight days after the delivery of the goods
- 6. Custom Duties**
- 6.1** The buyer will be liable for import custom duties if applicable in its country.
- 7. Order cancellation**
- 7.1** No order which has been accepted and confirmed by KAPPA srl may be cancelled by the buyer except with the agreement in writing of KAPPA srl and on terms that the request of order cancellation from the buyer is received before the start of the shipment preparation. In case the order is cancelled after the shipment preparation has started, KAPPA srl will be entitled to invoice to the buyer the costs incurred by KAPPA srl.
- 8. Property**
- 8.1** Notwithstanding delivery and the passing of risk in the goods, the property in the goods shall not pass to the buyer until KAPPA srl has received payment in full of the price of the goods and the buyer has fully performed all of the terms and conditions hereof.
- 8.2** Before transfer of ownership, the buyer will only be entitled to these goods with the prior written approval of KAPPA srl. If a third party seizes the goods, particularly if the goods are impounded, the buyer must inform KAPPA Srl immediately in writing and also point out to the third party immediately that KAPPA Srl have proprietary rights.
- 9. Returns**
- 9.1** No goods will be accepted for credit when returned without written permission from KAPPA Srl. No goods will be accepted for credit after one year from date of shipment.
- 10. Warranties and liability**
- 10.1** The warranty period is 24 months and begins when the goods are handed over to the final user. Defects in the goods will be corrected by KAPPA Srl after being informed of this by the buyer within this warranty period. KAPPA Srl will decide whether to replace or repair the goods and inform the buyer accordingly but KAPPA srl shall have no further liability to the buyer.
- 10.2** Every claim must be notified by the buyer to KAPPA Srl using the Warranty Claim Form provided by KAPPA Srl, with description of the fault and pictures showing and proving the claimed defect.
- 10.3** KAPPA Srl shall be under no liability in respect of any defect arising from fair wear and tear, willful damage, negligence, abnormal working conditions, failure to follow KAPPA Srl's instructions, whether oral or in writing, misuse or alteration of the goods without KAPPA Srl's approval.
- 10.4** If the claim is unfounded KAPPA srl reserves the right to claim reimbursement of the costs incurred from the buyer, if any.
- 10.5** KAPPA Srl shall be under no liability under the above warranty (or any other warranty, condition or guarantee) if the total price for the goods has not been paid by the due date for payment.
- 10.6** Except in respect of death or personal injury caused by KAPPA Srl's negligence, KAPPA Srl shall not be liable to the buyer by reason of any representation, unless fraudulent, or any implied warranty, condition or other term, or any duty at common law, or under the express terms of the present Terms and Conditions of sale, for any indirect, special or consequential loss or damage, whether for loss of profit or otherwise, costs, expenses or other claims for compensation whatsoever (whether caused by the negligence of KAPPA Srl, its employees or agents or otherwise) which arise out of or in connection with the supply of the goods or their use or resale by the buyer, and the entire liability of KAPPA Srl under or in connection with the sale of the goods shall not exceed the price of the goods, except as expressly provided in these Terms and Conditions.
- 10.7** KAPPA Srl shall not be liable to the buyer or be deemed to be in breach of these Terms and Conditions of Sale by reason of any delay in performing, or any failure to perform, any of KAPPA Srl's obligations in relation to the goods, if the delay or failure was due to any cause beyond KAPPA Srl's reasonable control.
- 11. Data protection**
- 11.1** If it has not been agreed to the contrary, KAPPA Srl will only use the buyer's data in order to carry out the sale contract. The buyer's permission is required to use this information for market and opinion research and for advertising.
- 12. General**
- 12.1** Changes and amendments to these Terms and Conditions of Sale must be in writing to be effective. There are no verbal secondary agreements.
- 12.2** If it has not been agreed to the contrary, the buyer may not transfer rights and obligations derived from the sale contract to a third party without KAPPA Srl's prior written agreement.
- 12.3** If any provision of these Terms and Conditions of Sale is or becomes invalid or unenforceable in whole or in part, the other provisions and the remainder of the provision in question shall not be affected. The contractual partners will agree to replace the invalid provision with a valid one that best corresponds to the economic aims of the contractual parties.
- 12.4** The present contract is governed by the laws of Italy.
- 12.5** The competent law courts of the place where KAPPA Srl has his registered office (Brescia, Italy) shall have exclusive jurisdiction in any action arising out of or in connection with this contract. However, as an exception to the principle here above, KAPPA Srl is in any case entitled to bring his action before the competent court of the place where the Distributor has his registered office. Should the Distributor have his seat out of EU, all dispute arising out of or in connection with the present General Conditions shall be finally settled under the Rules of Arbitration National and International Chamber of Milan by one or more arbitrators appointed in accordance with the said Rules.
- Note:** The solutions photographed in this catalog are examples of the range and KAPPA representative only. KAPPA reserve the right to modify wholly or in part, to add or remove products without prior notice.



*Travel
Collection*

**BORN TO
UNLIMITED
RIDE**

HEAD QUARTER

Kappa S.r.l. - Via Michelangelo, 6 - 25030 Barbariga (BS) - ph. +39 030 26 80 374 - fax +39 030 35 81 444
info@kappamoto.com - www.kappamoto.com

EXPORT SALES DEPARTMENT

ph. +39 030 2686970 - export@kappamoto.com



In any case.