

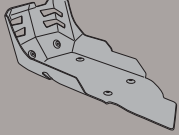







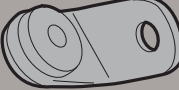

RP5103

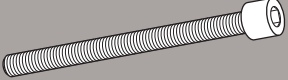
PARACOPPA - OIL CARTER PROTECTOR - SABOT MOTEUR - SPEZIFISCHER MOTORSCHUTZ - CUBRE CARTER

BMW F800GS (2008-2012)

N°	Descrizione	Caratteristiche	Codice	Quantità	
1	Paracoppa - Oil Carter Protector - Sabot Moteur - Spezifischer Motorschutz - Cubre Carter			1	
2	Supporto - Support - Support Halteung - Soporte		GL2134	1	
3	Supporto - Support - Support Halteung - Soporte		GL2027	1	
4	Vite - Screw Vis - Schraube Tornillo	TE M8x12	-	4	
5	Vite - Screw Vis - Schraube Tornillo	TEF M6x30		2	
6	Vite - Screw Vis - Schraube Tornillo	TCEI M8X110		1	
7	Dado - Bolt - Ecrou Mutter - Tuerca	Auto Bloccante Flangiato M6		2	
8	Distanziale - Spacer Entretoise - Distanzstueck Distanciador	Ø16x17 Rib. Ø10x10 foro 6.5mm	V623	2	
9	Rondella - Washer Rondelle - Scheibe Arandela	Zigrinata Ø8	814RONZ	4	
10	Rondella - Washer Rondelle - Scheibe Arandela	Ø6x18	-	2	
11	Gommino - Fairleader Chaumard - Gummi Goma	Z268		2	
12	Silent Block			4	

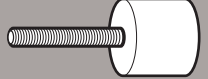
RP5103

PARACOPPA - OIL CARTER PROTECTOR - SABOT MOTEUR - SPEZIFISCHER MOTORSCHUTZ - CUBRE CARTER

BMW F800GS (2008-2012)

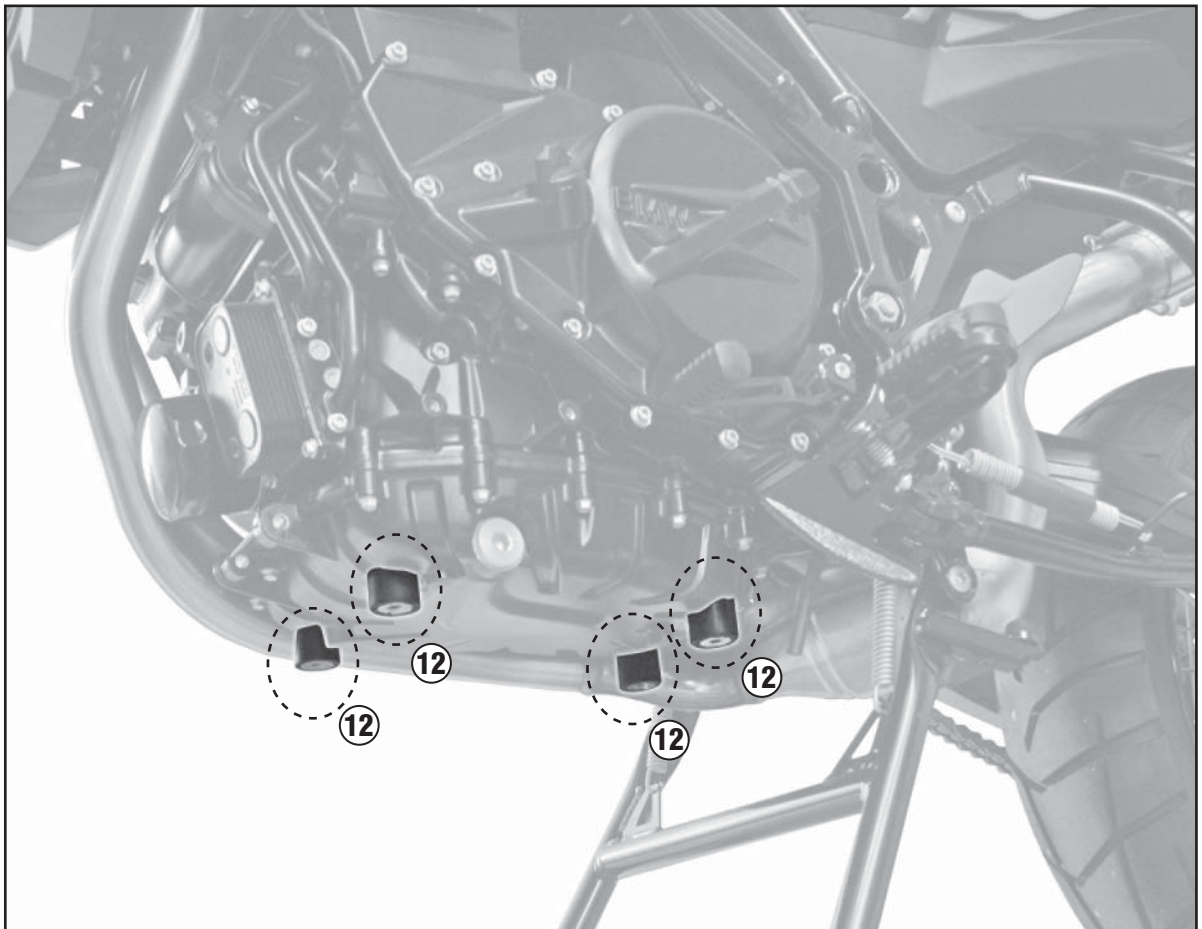
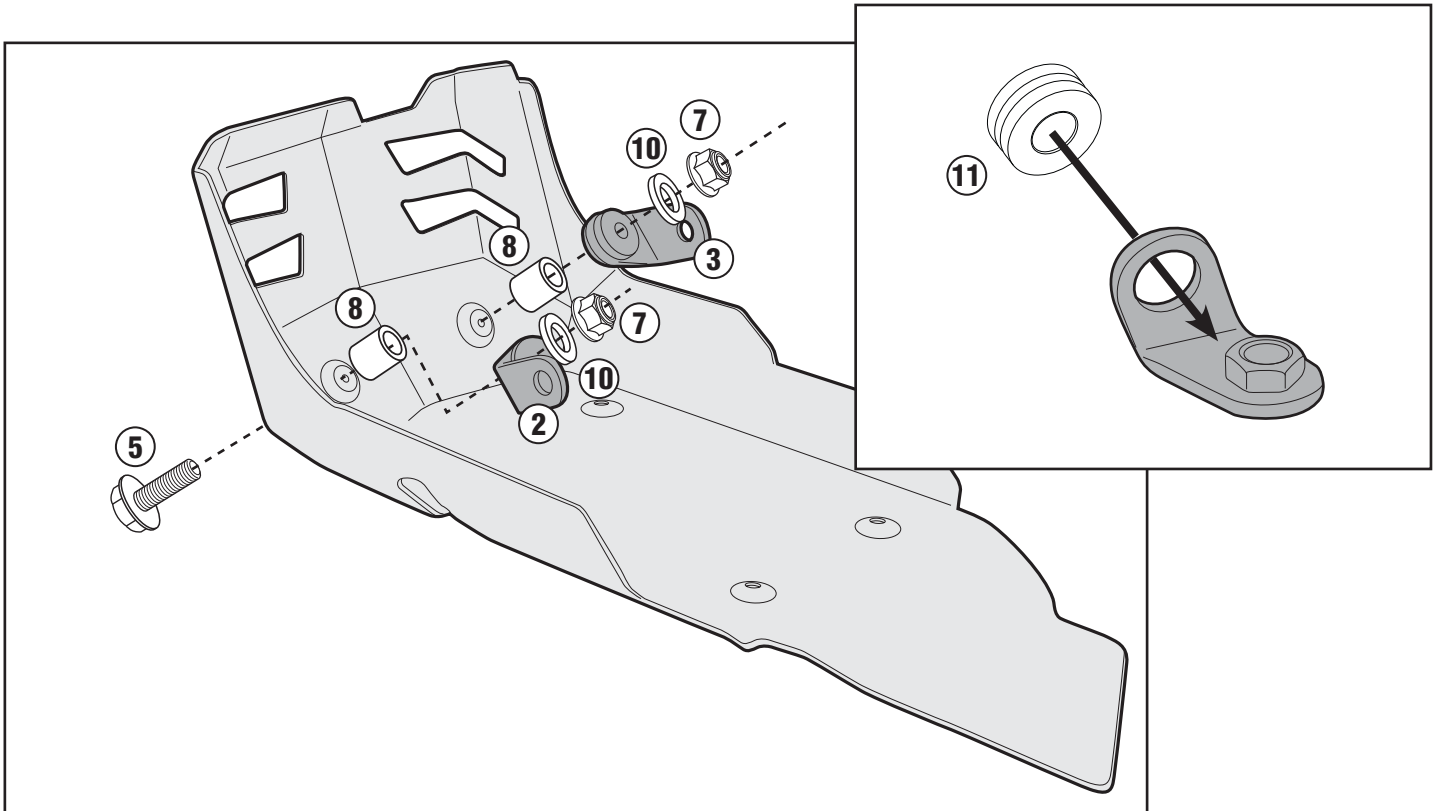

RP5103

PARACOPPA - OIL CARTER PROTECTOR - SABOT MOTEUR - SPEZIFISCHER MOTORSCHUTZ - CUBRE CARTER

BMW F800GS (2008-2012)

